



2016-2017 NEW



<u>CLASSIC</u>	<u>3</u>
<u>CRYSTAL</u>	<u>15</u>
<u>COUNTRY</u>	<u>23</u>
<u>MODERN</u>	<u>35</u>
<u>LOFT</u>	<u>51</u>
<u>TECHNO-LED</u>	<u>61</u>
<u>OUTDOOR</u>	<u>63</u>
<u>INDEX</u>	<u>76</u>

①



- * WHITE FABRIC SHADES WITH GOLDEN DECORATED BAND.
- * АБАЖУРЫ ИЗ БЕЛОЙ ТКАНИ С ЗОЛОТИСТОЙ УЗОРНОЙ ТЕСЬМОЙ.
- * MATT WHITE COLOR FRAME. МЕТАЛЛ БЕЛОГО МАТОВОГО ЦВЕТА.
- * BEST QUALITY CRYSTAL. ХРУСТАЛЬНЫЕ ПОДВЕСКИ ВЫСШЕГО КАЧЕСТВА.

CLASSIC

ALLA



① 1729-7P

D710*H400/1400
7*E14*40W,
METAL, GLASS,
CRYSTAL, FABRIC



② 1729-5P

D560*H400/1400
5*E14*40W
METAL, GLASS,
CRYSTAL, FABRIC



③ 1729-2W

W450*D260*H240
2*E14*40W,
METAL, FABRIC,
CRYSTAL



④ 1729-1W

W140*D280*H240
1*E14*40W
METAL, FABRIC,
CRYSTAL



①



* ANTIQUE WHITE PAINTED METAL FRAME.
АРМАТУРА АНТИЧНО БЕЛОГО ЦВЕТА .
* WHITE ORGANZA FABRIC SHADES.
АБАЖУРЫ ИЗ БЕЛОЙ ОРГАНЗЫ.



②

MALTA



① **1730-7P**

D710*H380/1380
Ø7*E14*40W
METAL, FABRIC



② **1730-1W**

W140*D260*H250
Ø1*E14*40W
METAL, FABRIC



③ **1730-5P**

D560*H360/1360
Ø5*E14*40W
METAL, FABRIC



④ **1730-2W**

W350*D240*H250
Ø2*E14*40W
METAL, FABRIC



③



④

LOTTA

① 1731-5P

D560*H430/1430
5*E14*40W,
METAL, FABRIC



② 1731-1W

W140*D290*H250
1*E14*40W
METAL, FABRIC



③ 1731-2W

W370*D260*H250
2*E14*40W,
METAL, FABRIC



④ 1731-7P

D710*H440/1440
7*E14*40W
METAL, FABRIC



* WHITE-GOLD METAL FRAME.
АРМАТУРА ЦВЕТА БЕЛОЕ ЗОЛОТО.
* WHITE FABRIC SHADES WITH PATTERN BRAID.
АБАЖУРЫ ИЗ БЕЛОЙ ТКАНИ С УЗОРНОЙ ТЕСЬМОЙ.

①



- * WHITE SILVER PAINTED METAL FRAME.
АРМАТУРА ОКРАШЕНА В ЦВЕТ БЕЛОЕ СЕРЕБРО.
- * WHITE ORGANZA FABRIC SHADES. WITH LACE APPLIQUE,
АБАЖУРЫ ИЗ БЕЛОЙ ОРГАНЗЫ С КРУЖЕВНОЙ АППЛИКАЦИЕЙ.
- * BEST QUALITY CRYSTAL. ХРУСТАЛЬ ВЫСШЕГО КАЧЕСТВА.

②



MELISSA

① 1732-8P



D810*H500/1500
 ⌀8*E14*40W
 METAL, FABRIC,
 CRYSTAL

② 1732-5P



D560*H450/1450
 ⌀5*E14*40W
 METAL, FABRIC,
 CRYSTAL

③ 1732-1W



W140*D270*H340
 ⌀1*E14*40W
 METAL, FABRIC,
 CRYSTAL

④ 1732-2W



W500*D250*H340
 ⌀2*E14*40W
 METAL, FABRIC,
 CRYSTAL

③



④



MUSA

①



① **1734-7P**

D800*H450/1450
 7*E14*40W,
 METAL, FABRIC,
 CRYSTAL



② **1734-1W**

W140*D250*H320
 1*E14*40W
 METAL, FABRIC,
 CRYSTAL



③ **1734-2W**

W380*D220*H320
 2*E14*40W,
 METAL, FABRIC,
 CRYSTAL



④ **1734-5P**

D560*H450/1450
 5*E14*40W
 METAL, FABRIC,
 CRYSTAL



②



④



③



* IVORY-GOLD METAL FRAME.
 АРМАТУРА ЦВЕТА СЛОНОВОЙ КОСТИ С ЗОЛОЧЕНИЕМ.
 * WHITE FABRIC SHADES WITH PATTERN BRAID.
 АБАЖУРЫ ИЗ БЕЛОЙ ТКАНИ С УЗОРНОЙ ТЕСЬМОЙ.
 * BEST QUALITY CRYSTAL. ХРУСТАЛЬ ВЫСШЕГО КАЧЕСТВА.



①



②



* WHITE PAINTED METAL FRAME.
АРМАТУРА ОКРАШЕНА В БЕЛЫЙ ЦВЕТ.
* BEST QUALITY CRYSTAL.
ХРУСТАЛЬ ВЫСШЕГО КАЧЕСТВА.

LANTA



① **1733-7P**

D720*H490/1490
Ø7*E14*40W
METAL, CRYSTAL



② **1733-1W**

W130*D290*H300
Ø1*E14*40W
METAL, CRYSTAL



③ **1733-2W**

W370*D260*H300
Ø2*E14*40W
METAL, CRYSTAL



④ **1733-5P**

D570*H450/1450
Ø5*E14*40W
METAL, CRYSTAL



④

③



POEM



① 1837-8P

D920*H330/1330
8*E14*40W,
METAL, CRYSTAL



② 1837-6P

D780*H330/1330
6*E14*40W
METAL, CRYSTAL



③ 1837-2W

W360*D310*H235
2*E14*40W,
METAL, CRYSTAL



②



③



* WHITE-GOLD METAL FRAME.
АРМАТУРА ЦВЕТА БЕЛОЕ ЗОЛОТО.
* BEST QUALITY CRYSTAL.
ХРУСТАЛЬ ВЫСШЕГО КАЧЕСТВА.



* WHITE-GOLD PAINTED FRAME.
АРМАТУРА БЕЛОГО ЦВЕТА С ЗОЛОТОЙ ПАТИНОЙ
* BEST QUALITY CRYSTAL. ХРУСТАЛЬ
ВЫСШЕГО КАЧЕСТВА.
* BIRDS MADE OF GYPSUM,
ПТИЧКИ СДЕЛАНЫ ИЗ ГИПСА.



CANARY

①



②



③



① **1835-7P**
D860*H420/1420
7*E14*40W
METAL, CRYSTAL,
GYPSUM



② **1835-1W**
D110*W350*H200
1*E14*40W
METAL, CRYSTAL,
GYPSUM



③ **1835-5P**
D710*H390/1390
5*E14*40W
METAL, CRYSTAL,
GYPSUM



* WHITE COLOR PAINTED METAL FRAME.
АРМАТУРА ОКРАШЕНА В БЕЛЫЙ ЦВЕТ.
* BIRDS MADE OF GYPSUM.
ПТИЧКИ СДЕЛАНЫ ИЗ ГИПСА.
* BEST QUALITY CRYSTAL.
ХРУСТАЛЬ ВЫСШЕГО КАЧЕСТВА.

①



②



③



④



CARDELLINO



① **1836-7P**

D720*H390/1390
7*E14*40W
METAL, CRYSTAL,
GYPSUM



② **1836-1T**

D250*H410
1*E14*40W
METAL, GYPSUM



③ **1836-2W**

W320*D270*H250
2*E14*40W
METAL, CRYSTAL,
GYPSUM



④ **1836-5P**

D620*H390/1390
5*E14*40W
METAL, CRYSTAL,
GYPSUM

①



②



③



* IVORY-GOLD PAINTED FRAME.
АРМАТУРА ЦВЕТА СЛОНОВОЙ КОСТИ
С ЗОЛОТОЙ ПАТИНОЙ.

* WHITE FABRIC SHADES WITH BAIGE DECORATED BAND.
АБАЖУРЫ ИЗ БЕЛОЙ ТКАНИ ОТДЕЛАНЫ
БЕЖЕВОЙ ТЕСЬМОЙ.

ONORE



① 1838-7P

D720*H430/1430
Ø7*E14*40W
METAL, CRYSTAL,
FABRIC



② 1838-1W

W140*D290*H310
Ø1*E14*40W
METAL, FABRIC



③ 1838-5P

D560*H420/1420
Ø5*E14*40W
METAL, CRYSTAL,
FABRIC



MARIPOSA

① 1839-5P



D560*H440/1440
5*E14*40W,
METAL, FABRIC

② 1839-1W



W140*D290*H310
1*E14*40W
METAL, FABRIC

③ 1839-7P



D720*H460/1460
7*E14*40W,
METAL, FABRIC,
CRYSTAL



①

②



③



* WHITE-GOLD PAINTED FRAME.
АРМАТУРА БЕЛОГО ЦВЕТА С ЗОЛОТОЙ ПАТИНОЙ.
* WHITE FABRIC SHADES WITH BAIGE DECORATED BAND.
АБАЖУРЫ ИЗ БЕЛОЙ ТКАНИ ОТДЕЛАНЫ БЕЖЕВОЙ ТЕСЬМОЙ.



CRYSTAL





BRANDY



- ① **1738-12P**
 D810*H500/1500
 12*E14*40W
 METAL, CRYSTAL,
 GLASS



- ② **1738-2W**
 D400*H290*W240
 2*E14*40W
 METAL, CRYSTAL,
 GLASS



- ③ **1738-1W**
 D250*H290*W240
 1*E14*40W
 METAL, CRYSTAL,
 GLASS



- ④ **1738-5P**
 D450*H450/1450
 5*E14*40W
 METAL, CRYSTAL,
 GLASS



- ⑤ **1738-8P**
 D570*H450/1450
 8*E14*40W
 METAL, CRYSTAL,
 GLASS



* GLASS AND CRYSTAL ELEMENTS OF CHAMPAGNE COLOR.
 СТЕКЛЯННЫЕ И ХРУСТАЛЬНЫЕ ЭЛЕМЕНТЫ ЦВЕТА ШАМПАНСКОГО.
 * GOLD METAL FRAME. АРМАТУРА ЗОЛОТОГО ЦВЕТА.
 * BEST QUALITY CRYSTAL PENDANTS.
 ХРУСТАЛЬНЫЕ ПОДВЕСКИ ВЫСШЕГО КАЧЕСТВА.





* CLEAR GLASS AND CRYSTAL ELEMENTS.
 * СТЕКЛЯННЫЕ И ХРУСТАЛЬНЫЕ ЭЛЕМЕНТЫ ПРОЗРАЧНОГО ЦВЕТА.
 * GOLD METAL FRAME. АРМАТУРА ЗОЛОТОГО ЦВЕТА.
 * BEST QUALITY CRYSTAL. ХРУСТАЛЬ ВЫСШЕГО КАЧЕСТВА.



MONREAL



① **1735-12P**
 D820*H570/1570
 12*E14*40W
 METAL, CRYSTAL,
 GLASS



② **1735-1W**
 D120*H330*W210
 1*E14*40W
 METAL, CRYSTAL,
 GLASS



③ **1735-2W**
 D470*H300*W240
 2*E14*40W
 METAL, CRYSTAL,
 GLASS



④ **1735-8P**
 D580*H450/1450
 8*E14*40W
 METAL, CRYSTAL,
 GLASS



⑤ **1735-5P**
 D500*H450/1450
 5*E14*40W
 METAL, CRYSTAL,
 GLASS



⑥ **1735-10P**
 D650*H450/1450
 10*E14*40W
 METAL, CRYSTAL,
 GLASS



SIMONE



②



③



④



* CLEAR GLASS AND CRYSTAL ELEMENTS.
 * СТЕКЛЯННЫЕ И ХРУСТАЛЬНЫЕ ЭЛЕМЕНТЫ ПРОЗРАЧНОГО ЦВЕТА.
 * GOLD METAL FRAME. АРМАТУРА ЗОЛОТОГО ЦВЕТА.
 * BEST QUALITY CRYSTAL. ХРУСТАЛЬ ВЫСШЕГО КАЧЕСТВА.

SIMONE

⑤



① **1736-12P**
 D820*H480/1480
 12*E14*40W
 METAL, CRYSTAL,
 GLASS



② **1736-6P**
 D520*H460/1460
 6*E14*40W
 METAL, CRYSTAL,
 GLASS



③ **1736-1W**
 D130*H300*W230
 1*E14*40W
 METAL, CRYSTAL,
 GLASS



④ **1736-2W**
 D450*H300*W230
 2*E14*40W
 METAL, CRYSTAL,
 GLASS



⑤ **1736-8P**
 D570*H470/1470
 8*E14*40W
 METAL, CRYSTAL,
 GLASS

MONPLAISIR



CRYSTAL





* CLEAR GLASS AND CRYSTAL ELEMENTS.
СТЕКЛЯННЫЕ И ХРУСТАЛЬНЫЕ ЭЛЕМЕНТЫ ПРОЗРАЧНОГО ЦВЕТА.
* GOLD METAL FRAME. АРМАТУРА ЗОЛОТОГО ЦВЕТА.
* BEST QUALITY CRYSTAL. ХРУСТАЛЬ ВЫСШЕГО КАЧЕСТВА.



MONPLAISIR



① **1737-2W**

D400*H310*W220
2*E14*40W
METAL, CRYSTAL,
GLASS



② **1737-5P**

D560*H500/1500
5*E14*40W
METAL, CRYSTAL,
GLASS



③ **1737-8P**

D710*H510/1510
8*E14*40W
METAL, CRYSTAL,
GLASS



* WHITE PAINTED METAL FRAME WITH GOLD DECORATIVE LAMP HOLDERS,
АРМАТУРА БЕЛОГО ЦВЕТА С ЗОЛОТЫМИ ДЕКОРАТИВНЫМИ ЦОКОЛЯМИ.
* DECORATIVE BIRDS PAINTED WITH WHITE AND GOLD COLORS,
ДЕКОРАТИВНЫЕ ПТИЦЫ ОКРАШЕНЫ В БЕЛЫЙ И ЗОЛОТОЙ ЦВЕТА.
* GU10 LED BULBS ARE INCLUDED, ЛАМПЫ GU10 LED В КОМПЛЕКТЕ.

RUDEL



①

MODELLO



②



* BROWN-GOLD PAINTED METAL FRAME,
АРМАТУРА ОКРАШЕНА В КОРИЧНЕВЫЙ ЦВЕТ С ЗОЛОТОЙ ПАТИНОЙ.
* CRYSTAL BEADS AND GLASS DROPS DECORATION.
СВЕТИЛЬНИК ДЕКОРИРОВАН ХРУСТАЛЬНЫМИ БУСИНАМИ И
СТЕКЛЯННЫМИ КАПЛЯМИ.

COUNTRY

TERRA



① **1782-4U**

D360*H340
4*GU10LED*5W,
METAL, GYPSUM



② **1744-5P**

D650*H850/1500
5*E14*40W,
METAL, GLASS



③ **1745-5P**

D420*H500/1200
5*E14*40W
METAL



④ **1746-5P**

D420*H500/1200
5*E14*40W,
METAL

②



③



* BROWN OR GOLD PAINTED FRAME.,
АРМАТУРА КОРИЧНЕВОГО ИЛИ ЗОЛОТОГО ЦВЕТА.
* ADJUSTABLE HEIGHT,
ВИСОТА РЕГУЛУЙУЕТСЯ.

ALBERO

①



① **1763-8P**
D660*H740/1740
2*E14*40W
METAL, WOOD



② **1763-5P**
D500*H620/1620
2*E14*40W
METAL, WOOD



③ **1763-2W**
W400*H425*D165
2*E14*40W
METAL, WOOD

②



③



* DIRTY GREY COLOR PAINTED METAL FRAME.
АРМАТУРА ОКРАШЕНА В ГРЯЗНО СЕРЫЙ ЦВЕТ.
* DECORATIVE ELEMENTS MADE OF WOOD.
ДЕКОРАТИВНЫЕ ЭЛЕМЕНТЫ ВЫПОЛНЕННЫ ИЗ ДЕРЕВА.



HERDE



① **1760-1P**
 D180*H350/780
 1*E27*40W
 METAL

② **1760-3P**
 D350*H320/680
 3*E14*40W
 METAL



③ **1786-2W**
 W350*D200*H570
 2*E14*40W
 METAL,



④ **1787-2W**
 W350*D200*H570
 2*E14*40W
 METAL,



SCHILD



* BROWN PAINTED METAL FRAME.
 АРМАТУРА ОКРАШЕНА В КОРИЧНЕВЫЙ ЦВЕТ .



①



②

PAJARITOS



① **1750-6P**
 D680*H500/1500
 6*E14*40W
 METAL, GLASS



② **1750-1W**
 W280*H250*D250
 1*E14*40W
 METAL, GLASS



③ **1750-9P**
 D900*H530/1530
 9*E14*40W
 METAL, GLASS



③



* GOLD METAL FRAME.
 АРМАТУРА ЗОЛОТОГО ЦВЕТА.
 * BIRDS MADE OF CLEAR GLASS.
 ПТИЦЫ ИЗГОТОВЛЕНЫ ИЗ ПРОЗРАЧНОГО СТЕКЛА.





②



①

PAJARITOS



① **1751-1W**

W280*H250*D250
 1*E14*40W
 METAL, GLASS



② **1751-6P**

D680*H500/1500
 6*E14*40W
 METAL, GLASS



③ **1751-9P**

D900*H530/1530
 9*E14*40W
 METAL, GLASS

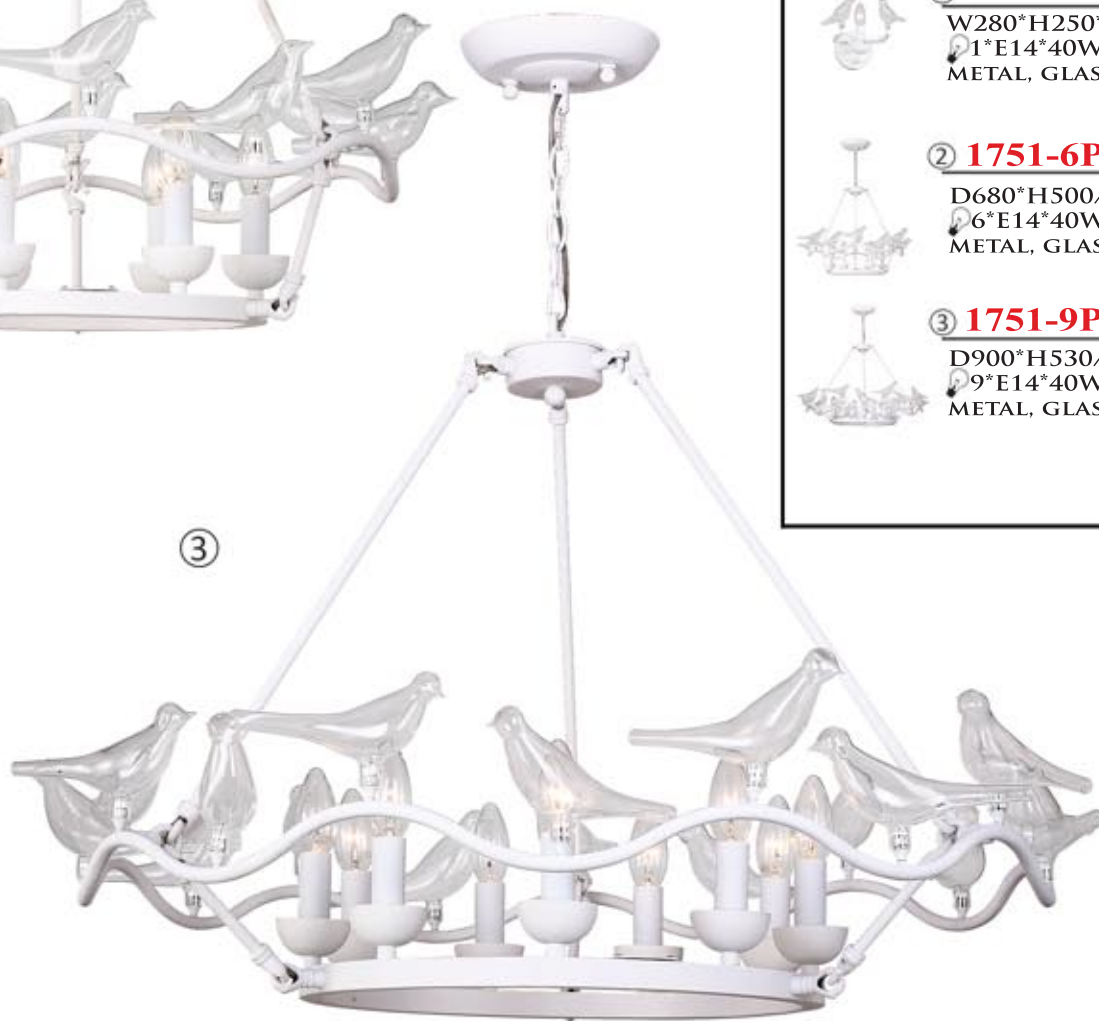

③



* MATT WHITE PAINTED METAL FRAME.
 АРМАТУРА БЕЛОГО МАТОВОГО ЦВЕТА.
 * BIRDS MADE OF CLEAR GLASS.
 ПТИЦЫ ИЗГОТОВЛЕНЫ ИЗ ПРОЗРАЧНОГО СТЕКЛА.

①



②



③



* IVORY-GOLD OR BLACK-GOLD PAINTED METAL FRAME.
 АРМАТУРА ОКРАШЕНА В ЦВЕТ СЛОНОВОЙ КОСТИ ИЛИ ЧЕРНЫЙ ЦВЕТ С ЗОЛОТОЙ ПАТИНОЙ.
 *GLASS SHADES. СТЕКЛЯННЫЕ ПЛАФОНЫ.

GUMBATA

① 1795-4U

W775*H180*D180
 4*E14*40W
 METAL, GLASS



② 1795-3U

D420*H150
 3*E14*40W
 METAL, GLASS



③ 1795-1W

W110*H175*D150
 1*E14*40W
 METAL, GLASS



④ 1795-2U

L380*W180*H180
 2*E14*40W
 METAL, GLASS



⑤ 1794-1W

W110*H175*D150
 1*E14*40W
 METAL, GLASS



⑥ 1794-4U

W775*H180*D180
 4*E14*40W
 METAL, GLASS



⑦ 1794-2U

L380*W180*H180
 2*E14*40W
 METAL, GLASS



⑧ 1794-3U

D420*H150
 3*E14*40W
 METAL, GLASS



⑤



⑥



⑦



⑧





* WHITE-GOLD OR BLACK-GOLD PAINTED METAL FRAME.
АРМАТУРА ОКРАШЕНА В БЕЛЫЙ ИЛИ ЧЕРНЫЙ ЦВЕТ С ЗОЛОТОЙ ПАТИНОЙ.

①



②



ARABIAN DREAM

① **1797-3U**

D420*H160
3*E14*40W
METAL, CRYSTAL



② **1797-2U**

L380*W195*H175
2*E14*40W
METAL, CRYSTAL



③ **1797-1W**

W135*H195*D150
1*E14*40W
METAL, CRYSTAL



④ **1796-1W**

W135*H195*D150
1*E14*40W
METAL, CRYSTAL



⑤ **1796-3U**

D420*H160
3*E14*40W
METAL, CRYSTAL



⑥ **1796-2U**

L380*W195*H175
2*E14*40W
METAL, CRYSTAL



③

④



⑤



⑥

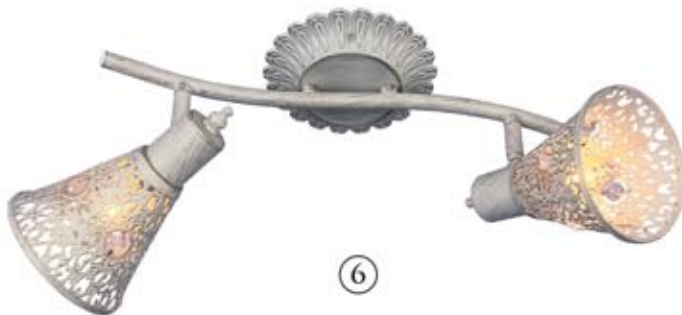



①

②

③



* WHITE-GOLD OR BLACK-GOLD PAINTED METAL FRAME.
АРМАТУРА ОКРАШЕНА В БЕЛЫЙ ИЛИ ЧЕРНЫЙ ЦВЕТ С ЗОЛОТОЙ ПАТИНОЙ.

MARTOS

① **1799-4U**
L775*W160*H175
4*E14*40W
METAL

② **1799-2U**
L380*W160*H175
2*E14*40W
METAL

③ **1799-3U**
D370*H150
3*E14*40W
METAL

④ **1799-1W**
W100*H155*D150
1*E14*40W
METAL

⑤ **1798-1W**
W100*H155*D150
1*E14*40W
METAL

⑥ **1798-3U**
D370*H150
3*E14*40W
METAL

⑦ **1798-2P**
L380*W160*H175
2*E14*40W
METAL

⑧ **1798-4U**
L775*W160*H175
4*E14*40W
METAL



④



⑤



⑥



⑦



⑧





①



②

GLOBI



① **1801-1P1**
 D325*H340/1400
 1*E27*60W
 METAL, CRYSTAL



② **1801-1P**
 D165*H185/1330
 1*E14*40W
 METAL, CRYSTAL



③ **1801-1W**
 W165*H205*D240
 1*E14*40W
 METAL, CRYSTAL

* BLACK METAL FRAME WITH GOLD PAINTED DECORATION.
 АРМАТУРА ЧЕРНОГО ЦВЕТА С ЗОЛОЧЕНИЕМ.
 * BEST QUALITY CRYSTAL. ХРУСТАЛЬ ВИСШЕГО КАЧЕСТВА.



③

TERRA



① **1800-1P**
D205*H290/1350
1*E27*60W,
METAL



② **1800-3P**
D315*H435/1250
3*E14*40W,
METAL



* BLACK COLOR PAINTED FRAME WITH GOLD PAINTED DECORATION.
АРМАТУРА ЧЕРНОГО ЦВЕТА С ЗОЛОЧЕНИЕМ ДЕКОРАТИВНЫХ ЭЛЕМЕНТОВ.



* BLACK COLOR PAINTED FRAME WITH GOLD PAINTED DECORATION.
АРМАТУРА ЧЕРНОГО ЦВЕТА С ЗОЛОЧЕНИЕМ
ДЕКОРАТИВНЫХ ЭЛЕМЕНТОВ.

GLOCKE



① 1802-1P

L250*W250*H245/1060
1*E27*60W,
METAL, GLASS



② 1802-4P

L300*W300*H340/1150
4*E14*40W,
METAL, GLASS

①



②



MODERN





①



②



③



④

COSMICS



① **1740-9U**
D840*H500
9*G9*40W
METAL



② **1740-9P**
D650*H140/860
9*G9*40W
METAL



③ **1739-9U**
D840*H500
9*G9*40W
METAL



④ **1739-9P**
D650*H140/860
9*G9*40W
METAL



* BLACK OR WHITE METAL FRAME WITH GOLD DECORATION.
АРМАТУРА ОКРАШЕНА В ЧЕРНЫЙ ИЛИ БЕЛЫЙ ЦВЕТ
С ЗОЛОТОЙ ОТДЕЛКОЙ ДЕКОРАТИВНЫХ ЭЛЕМЕНТОВ.
* CEILING LAMPS ARE FLEXIBLE.
ПОТОЛОЧНЫЕ СВЕТИЛЬНИКИ ГИБКИЕ.
* G9 BULBS ARE INCLUDED. ЛАМПЫ G9 В КОМПЛЕКТЕ.

BOLILLAS



① **1841-6P**
D850*H350/600
6*E27*40W,
METAL, GLASS



② **1840-6P**
D850*H350/600
6*E27*40W,
METAL, GLASS



* GOLD OR BLACK METAL FRAME.
АРМАТУРА ЗОЛОТОГО ИЛИ ЧЕРНОГО ЦВЕТА.
* GREY OR CHAMPAGNE COLOR GLASSES.
СТЕКЛА СЕРОГО ЦВЕТА ИЛИ ЦВЕТА ШАМПАНСКОГО.
* ADJUSTABLE HEIGHT OF THE FIXTURE.
РЕГУЛИРУЕМАЯ ВЫСОТА СВЕТИЛЬНИКА.

PALLINO



* GOLD WITH BLACK OR CHROME WITH WHITE METAL FRAME.
ЗОЛОТОЕ С ЧЕРНЫМ ИЛИ ХРОМОВОЕ С БЕЛЫМ
ПОКРЫТИЕ АРМАТУРЫ.
* FREELY ADJUSTABLE SHADES. ПЛАФОНЫ ВРАЩАЮТСЯ.
* G9 BULBS ARE INCLUDED. ЛАМПЫ G9 В КОМПЛЕКТЕ.



① **1842-6P**
D760*H250/780
6*G9*40W,
METAL



② **1843-6P**
D760*H250/780
6*G9*40W,
METAL

①



②



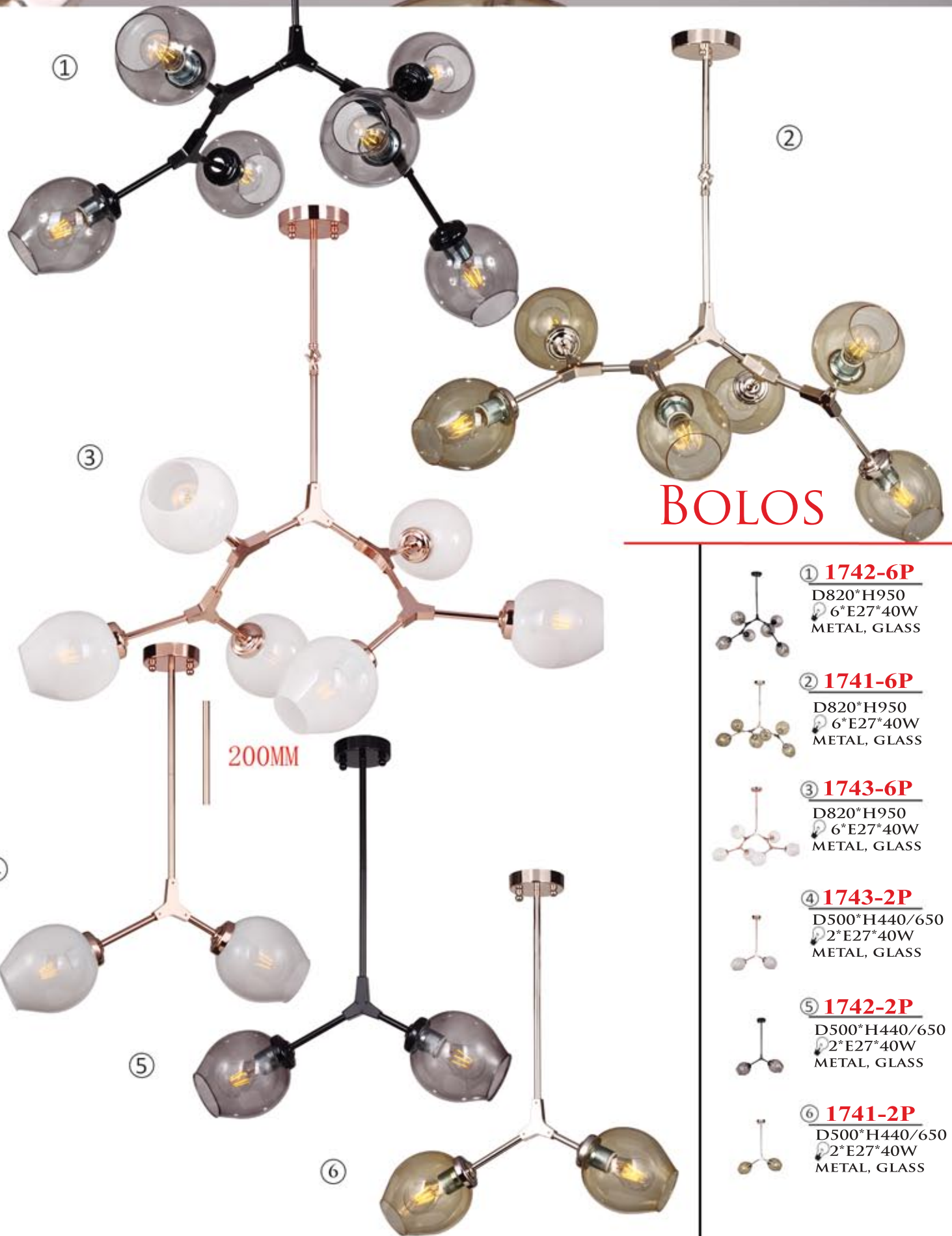

BOLOS

- 

① 1742-6P
 D820*H950
 6*E27*40W
 METAL, GLASS
- 

② 1741-6P
 D820*H950
 6*E27*40W
 METAL, GLASS
- 

③ 1743-6P
 D820*H950
 6*E27*40W
 METAL, GLASS
- 

④ 1743-2P
 D500*H440/650
 2*E27*40W
 METAL, GLASS
- 

⑤ 1742-2P
 D500*H440/650
 2*E27*40W
 METAL, GLASS
- 

⑥ 1741-2P
 D500*H440/650
 2*E27*40W
 METAL, GLASS

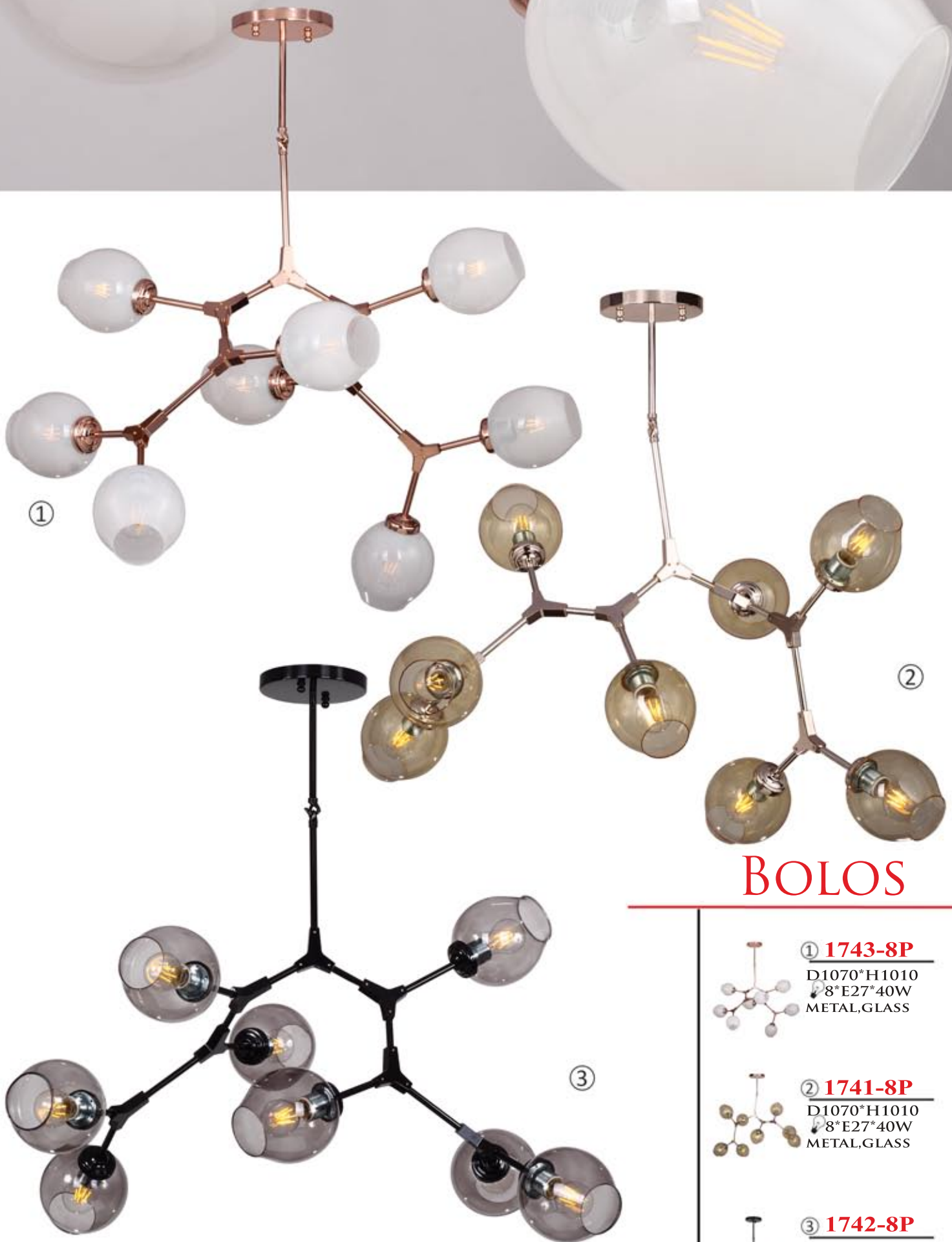

BOLOS

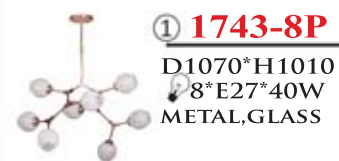

① **1743-8P**

D1070*H1010
 8*E27*40W
 METAL, GLASS



② **1741-8P**

D1070*H1010
 8*E27*40W
 METAL, GLASS



③ **1742-8P**

D1070*H1010
 8*E27*40W
 METAL, GLASS



* 3 COLORS AVAILABLE: BLACK METAL FRAME WITH GREY GLASSES,
 LIGHT GOLD METAL FRAME WITH CHAMPAGNE GLASSES AND COPPER
 METAL FRAME WITH WHITE GLASSES.
 ТРИ ЦВЕТА НА ВЫБОР: ЧЕРНАЯ АРМАТУРА С СЕРЫМИ СТЕКЛАМИ,
 СВЕТЛО ЗОЛОТАЯ АРМАТУРА СО СТЕКЛАМИ ЦВЕТА ШАМПАНСКОГО И
 АРМАТУРА МЕДНОГО ЦВЕТА С БЕЛЫМИ СТЕКЛАМИ.



ELLISSE



① 1749-6U

D700*H400
6*LED*3W
METAL, ACRYL



② 1749-8U

D750*H500
8*LED*3W
METAL, ACRYL



③ 1748-6U

D700*H400
6*LED*3W
METAL, ACRYL



④ 1748-8U

D750*H500
8*LED*3W
METAL, ACRYL

③



④

ELLISSE



* 2 COLORS AVAILABLE: BLACK METAL FRAME WITH COPPER DECORATION OR WHITE FRAME WITH GOLD DECORATION.
ДВА ЦВЕТА НА ВЫБОР: ЧЕРНЫЙ ЦВЕТ АРМАТУРЫ С МЕДНЫМ ДЕКОРОМ ИЛИ БЕЛЫЙ С ЗОЛОТЫМ ДЕКОРОМ.



① 1748-12U

D920*H600
12*LED*3W,
METAL, ACRYL



② 1749-12U

D920*H600
12*LED*3W,
METAL, ACRYL





ELECTRON



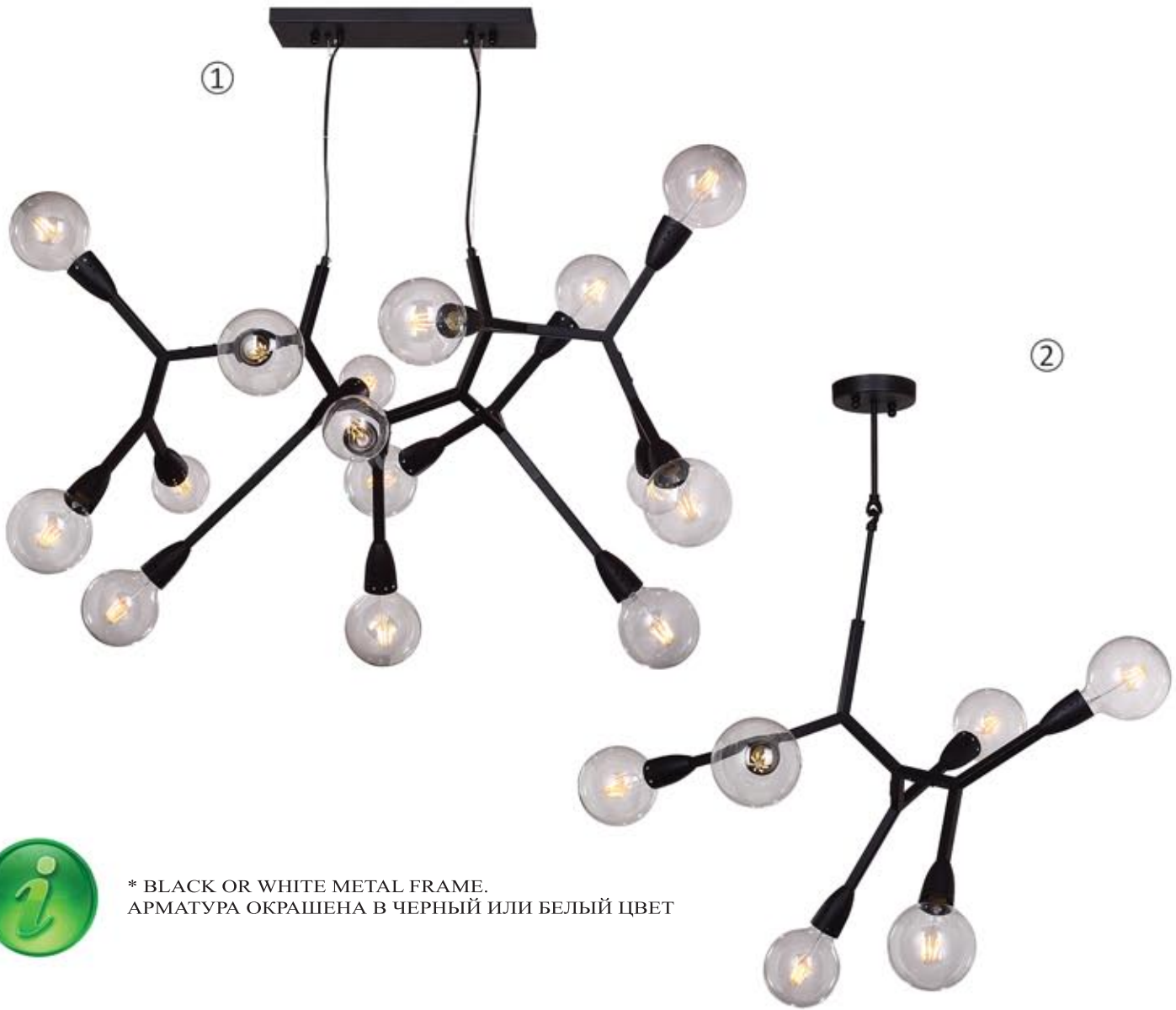

* BLACK OR WHITE METAL FRAME.
АРМАТУРА ОКРАШЕНА В ЧЕРНЫЙ ИЛИ БЕЛЫЙ ЦВЕТ

ELECTRON

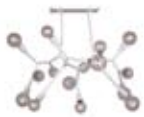

① **1755-15P**
D1050*H750/1400
15*E27*40W
METAL



② **1754-15P**
D1050*H750/1400
15*E27*40W
METAL



③ **1754-6P**
D900*H1000
6*E27*40W
METAL



④ **1755-6P**
D900*H1000
6*E27*40W
METAL





* BLACK OUTSIDE AND WHITE INSIDE METAL SHADES.
 АБАЖУРЫ ЧЕРНЫЕ СНАРУЖИ И БЕЛЫЕ ИЗНУТРИ.
 * CHROME DECORATION.
 ДЕКОРАТИВНЫЕ ЭЛЕМЕНТЫ ЦВЕТА ХРОМ.
 * ADJUSTABLE SHADES. ПОВОРОТНЫЕ АБАЖУРЫ.

HUMPEN



① **1757-9P**
 D1100*H600/800
 9*E14*40W
 METAL



② **1757-1W**
 W125*D300*H150
 1*E14*40W
 METAL



③ **1757-6P**
 D920*H500/700
 6*E14*40W
 METAL



HUMPEN

① 1758-6P

D920*H500/700
6*E14*40W,
METAL



② 1758-1W

W125*D300*H150
1*E14*40W
METAL



③ 1758-9P

D1100*H600/800
9*E14*40W,
METAL



①



③



②



* WHITE COLOR METAL SHADES.
АБАЖУРЫ БЕЛЫЕ ЦВЕТА.
* GOLD DECORATION.
ДЕКОРАТИВНЫЕ ЭЛЕМЕНТЫ ЗОЛОТОГО ЦВЕТА.
* ADJUSTABLE HEIGHT. РЕГУЛИРУЕМАЯ ВЫСОТА.

GIRO



① **1764-18P**

D400/600/800*H600/1800
 LED*146W,
 4000K,
 METAL, ACRYL



② **1764-10P**

D400/600*H400/1400
 LED*80W,
 4000K,
 METAL, ACRYL



③ **1764-6P**

D600*H1200MAX
 LED*48W,
 4000K,
 METAL, ACRYL



④ **1764-4P**

D400*H1200MAX
 LED*32W,
 4000K,
 METAL, ACRYL



* BLACK PAINTED METAL FRAME.
 АРМАТУРА ОКРАШЕНА В ЧЕРНЫЙ ЦВЕТ.
 * WHITE ACRYLIC COVER.
 БЕЛОЕ АКРИЛОВОЕ ПОКРЫТИЕ.

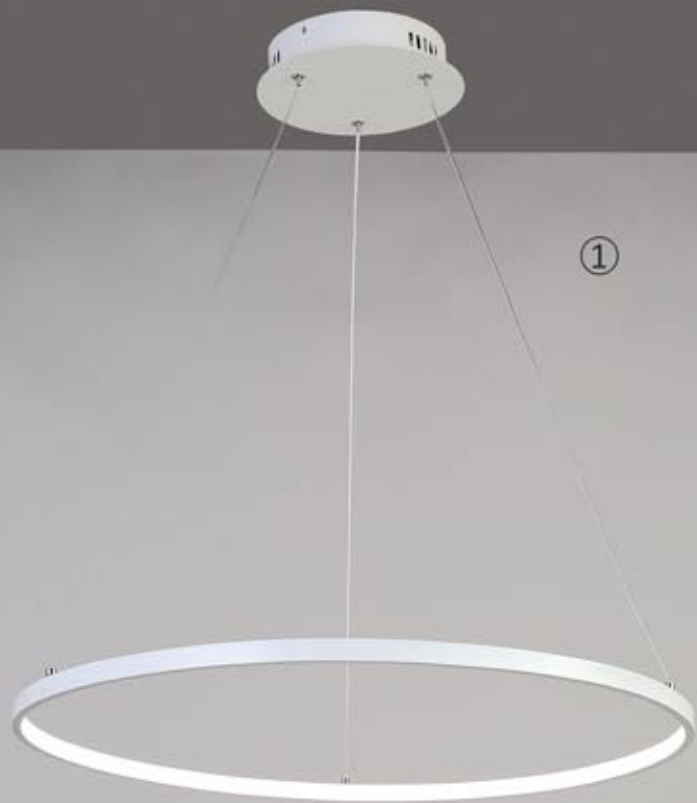

GIRO



① **1765-6P**

D600*H1200MAX
 LED*48W,
 4000K,
 METAL, ACRYL

② **1765-10P**

D400/600*H400/1400
 LED*80W,
 4000K,
 METAL, ACRYL

③ **1765-18P**

D400/600/800*H600/1800
 LED*146W,
 4000K,
 METAL, ACRYL

④ **1765-4P**

D400*H1200MAX
 LED*32W,
 4000K,
 METAL, ACRYL



* WHITE PAINTED METAL FRAME.
 АРМАТУРА ОКРАШЕНА В БЕЛЫЙ ЦВЕТ.
 * WHITE ACRYLIC COVER.
 БЕЛОЕ АКРИЛОВОЕ ПОКРЫТИЕ.



SPLATTER

① 1780-1W

W200*H155*D135
LED*7W,
4000K,
METAL, CRYSTAL



② 1780-18P

D800/600/400*H1500
LED*28W+42W+56W
4000K,
METAL, CRYSTAL



SPLATTER

① **1692-1W**

W200*D129*H233
 1*E14*40W
 METAL, CRYSTAL



② **1780-8P**

D800*H1030
 LED*56W,
 4000K,
 METAL, CRYSTAL



③ **1780-3P**

D300*H630
 LED*20W,
 4000K,
 METAL, CRYSTAL



④ **1780-6P**

D600*H910
 LED*42W,
 4000K,
 METAL, CRYSTAL

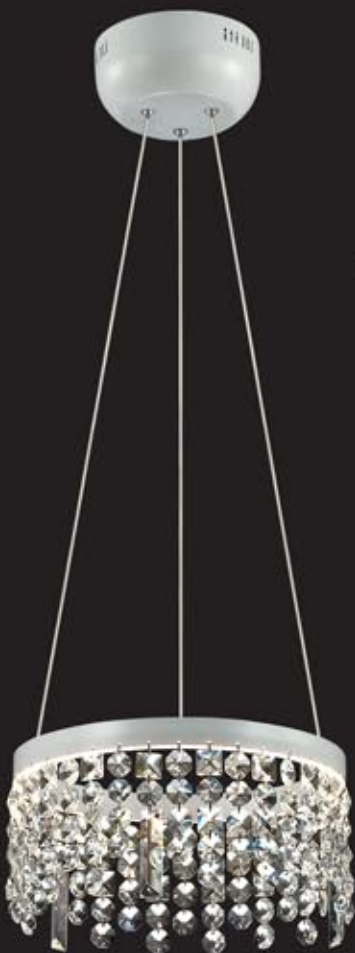

* MATT WHITE METALL FRAME.
 АРМАТУРА БЕЛОГО МАТОВОГО ЦВЕТА.
 * BEST QUALITY CRYSTAL.
 ХРУСТАЛЬ ВЫСШЕГО КАЧЕСТВА.

LOFT



* COFFEE COLOR PAINTED METAL FRAME.
АРМАТУРА ОКРАШЕНА В КОФЕЙНЫЙ ЦВЕТ.
* SLIDING MECHANISM.
РАЗДВИЖНОЙ МЕХАНИЗМ АРМАТУРЫ.

BELLOWS



WINCH

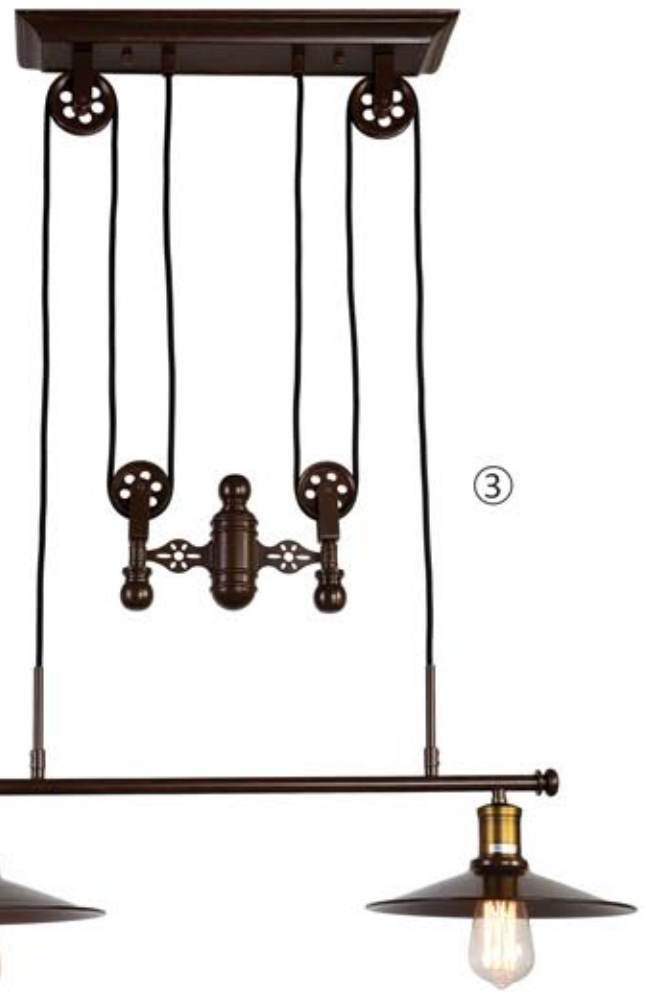

① **1761-1U**
D300*H1200
1*E27*60W
METAL

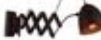

② **1761-1W**
D1050*W190*H220
1*E27*60W
METAL



③ **1762-2P**
W260*L790*H1200
2*E27*60W
METAL



④ **1762-1P**
D260*H1200
1*E27*60W
METAL



* COFFEE COLOR PAINTED METAL FRAME
WITH BRASS DECORATIVE LAMPHOLDER.
АРМАТУРА ОКРАШЕНА В КОФЕЙНЫЙ ЦВЕТ С
ДЕКОРАТИВНЫМИ ЦОКОЛЯМИ БРОНЗОВОГО ЦВЕТА.
* WINCH MECHANISM FOR HEIGHT ADJUSTING.
МЕХАНИЗМ ЛЕБЕДКИ ДЛЯ ИЗМЕНЕНИЯ
ВЫСОТЫ ПОДВЕСА.

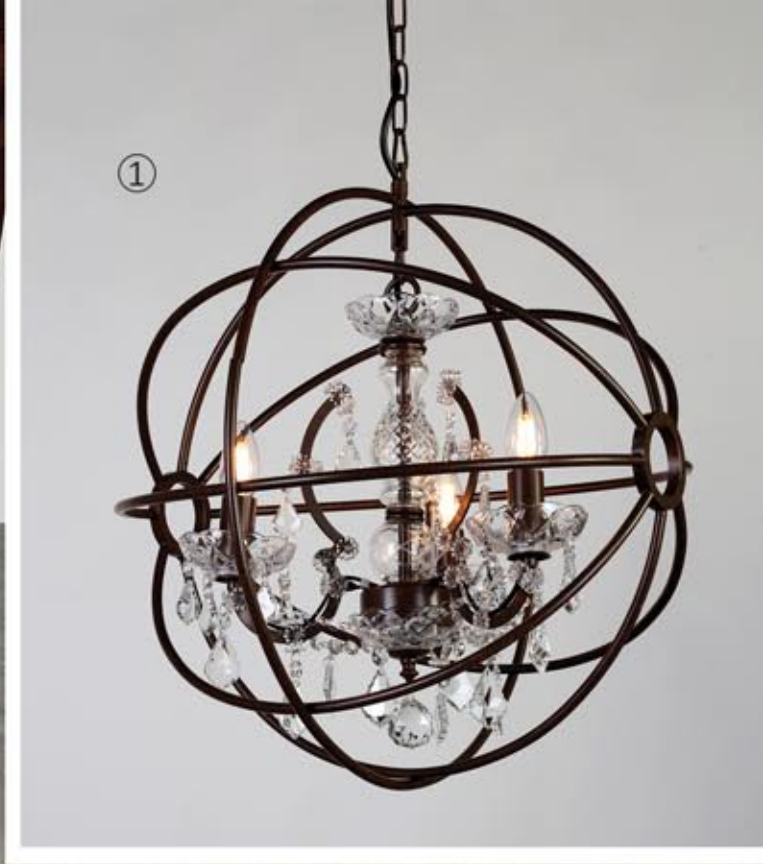

②



* DARK BROWN PAINTED METAL FRAME
ТЕМНО-КОРИЧНЕВАЯ АРМАТУРА.
*BEST QUALITY CRYSTAL,
ХРУСТАЛЬ ВИСШЕГО КАЧЕСТВА.

ORBIT



① **1834-3P**
D520*H540/1540
3*E14*40W
METAL, GLASS,
CRYSTAL



② **1834-5P**
D610*H630/1630
5*E14*40W
METAL, GLASS,
CRYSTAL

GABBIA

HULL



* BLACK OR WHITE METAL FRAME,
ЧЕРНАЯ ИЛИ БЕЛАЯ АРМАТУРА,
* BIRDS MADE OF WHITE BLOWN GLASS
ПТИЦЫ ИЗ БЕЛОГО СТЕКЛА.

①



②



③



* SILVER-BLACK COLOR METAL FRAME
АРМАТУРА ОКРАШЕНА В СЕРЕБИСТО-
ЧЕРНЫЙ ЦВЕТ
* BEST QUALITY CRYSTAL,
ХРУСТАЛЬ ВЫСШЕГО КАЧЕСТВА.

CARRERA



① **1752-1P**
D320*H350/1030
1*E27*40W
METAL, GLASS



② **1753-1P**
D320*H350/1030
1*E27*40W
METAL, GLASS



③ **1781-1P**
D300*H280/1280
1*E27*60W
METAL, CRYSTAL



④ **1747-1PC**
D240*H320/1320
1*E27*40W
METAL

④



«2in1» fixing system
pendant-ceiling/
ПОДВЕС-ПОТОЛОЧНЫЙ



* BLACK COLOR METAL FRAME,
АРМАТУРА ОКРАШЕНА В ЧЕРНЫЙ ЦВЕТ,
* «2IN1» FIXING SYSTEM,
СИСТЕМА 2В1 - ПРИ УДАЛЕНИИ ПРОВОДА
ПОДВЕС ПРЕВРАЩАЕТСЯ В ПОТОЛОЧНЫЙ
СВЕТИЛЬНИК.

MESH

①



① **1783-6P**

D580*H490/1490
6*E27*60W
METAL



② **1784-1W**

W160*H380*D120
1*E27*60W
METAL



③ **1783-1W**

W130*H285*D180
1*E27*60W
METAL



④ **1783-1P**

D180*H530/1530
1*E27*60W
METAL



②



③



④



* BLACK PAINTED METAL FRAME.
АРМАТУРА ЧЕРНОГО ЦВЕТА.



①



BROOK



① **1785-3P**
L280*W280*H355/1335
3*E27*60W
METAL, GLASS



② **1785-1P**
L165*W165*H225/1225
1*E27*60W
METAL, GLASS



③ **1785-1U**
L165*W165*H185
1*E27*60W
METAL, GLASS



④ **1785-1W**
W165*D185*H165
1*E27*60W
METAL, GLASS

②



③



④



* BLACK COLOR PAINTED METAL FRAME.
АРМАТУРА ОКРАШЕНА В ЧЕРНЫЙ ЦВЕТ.
* INSERT GLASS WITH FLOWING WATER EFFECT
ВСТАВКИ ИЗ СТЕКЛА С ЭФФЕКТОМ СТРУЯЩЕЙСЯ ВОДЫ.



①



②



③



④



* BLACK PAINTED FRAME WITH BRASS DECORATIVE LAMPHOLDER, АРМАТУРА ЧЕРНОГО ЦВЕТА С ДЕКОРАТИВНЫМИ ЦОКОЛЯМИ БРОНЗОВОГО ЦВЕТА.

STRAINER



① **1788-1P**
D130*H260/1260
1*E27*60W
METAL



② **1788-2P**
L550*W130*H350/1200
2*E27*60W
METAL



③ **1789-1W**
W100*D115*H300
1*E27*60W
METAL



④ **1788-4P**
D600*H350/1200
4*E27*60W
METAL



⑤ **1788-1W**
L120*E140*H350
1*E27*60W
METAL



⑥ **1789-4P**
D480*H480/1300
4*E27*60W
METAL



⑥



⑤





BOBINA

① **1790-1P**

D200*H220/1220
 1*E27*60W
 METAL

② **1791-1P**

D200*H220/1220
 1*E27*60W
 METAL

③ **1792-1P**

D200*H220/1220
 1*E27*60W
 METAL



* 3 COLORS ARE AVAILABLE: WHITE-GOLD,
 RUSTY-BROWN AND MATT BLACK.
 3 ЦВЕТА НА ВЫБОР: ЗОЛОТИСТО-БЕЛЫЙ,
 РЫЖЕВАТО-КОРИЧНЕВЫЙ И МАТОВЫЙ ЧЕРНЫЙ.



* BLACK PAINTED METAL FRAME WITH
DARK GREY DECORATIVE COILS.
АРМАТУРА ЧЕРНОГО ЦВЕТА С ТЕМНО-СЕРЫМИ
ДЕКОРАТИВНЫМИ КАТУШКАМИ.



①

SPOOL

②



③



① **1793-5P**

D578*H1005
5*E27*60W
METAL, GYPSUM



② **1793-1P**

D120*H1355
1*E27*60W
METAL, GYPSUM



③ **1793-1W**

W120*D165*H315
1*E27*60W
METAL, GYPSUM

HELIX



* WHITE COLOR PAINTED FRAME WITH GOLD DECORATION.
АРМАТУРА БЕЛОГО ЦВЕТА С ЗОЛОТЫМИ
ДЕКОРАТИВНЫМИ ЭЛЕМЕНТАМИ.



① **1756-5U**
D620*H560
5*E27*40W,
METAL



② **1756-1W**
W140*H250*D245
1*E27*40W,
METAL





①



②



③



④

KUPFER



① **1846-3P**
D300*H320/1100
3*E14*40W
METAL



② **1846-1P**
D200*H220/1000
1*E27*40W
METAL



③ **1845-1P**
D210*H150/930
1*E27*40W
METAL



④ **1844-1P**
D130*H250/1030
1*E27*40W
METAL



* COPPER ELECTROPLATING FRAME.
АРМАТУРА ЦВЕТА МЕДНОЙ ГАЛЬВАНИКИ.



PROJECTOR



① **1768-1U**
L108*W131*H210
1*LED*20W,
4000K, IP21
METAL



② **1769-1U**
L108*W131*H210
1*LED*20W,
4000K, IP21
METAL



③ **1766-1U**
L105*W108*H225
1*LED*20W,
4000K, IP21
METAL



④ **1767-1U**
L105*W108*H225
1*LED*20W,
4000K, IP21
METAL



⑤ **1770-1U**
L108*W108*H240
1*LED*20W,
4000K, IP21
METAL



⑥ **1771-1U**
L108*W108*H240
1*LED*20W,
4000K, IP21
METAL



⑦ **1772-1U**
L95*W108*H235
1*LED*20W,
4000K, IP21
METAL



⑧ **1773-1U**
L95*W108*H235
1*LED*20W,
4000K, IP21
METAL



* BLACK OR WHITE COLOR PAINTED WALL&CEILING FIXTURES.
НАСТЕННО-ПОТОЛОЧНЫЕ СВЕТИЛЬНИКИ ЧЕРНОГО ИЛИ
БЕЛОГО ЦВЕТОВ.
* ADJUSTABLE PLAFONDS,
УГОЛ НАКЛОНА ПЛАФОНОВ МОЖНО ИЗМЕНЯТЬ.



* BLACK OR WHITE COLOR PAINTED FRAME.
СВЕТИЛЬНИКИ ЧЕРНОГО ИЛИ БЕЛОГО ЦВЕТОВ.
* ADJUSTABLE LIGHT SOURCE.
ПОВОРОТНЫЙ ИСТОЧНИК СВЕТА.



①



②



③



④



⑤



⑥



REFLECTOR



① 1774-1C

D75*H53
1*LED*5W,
4000K, IP21
METAL



② 1775-1C

D87*H60
1*LED*7W,
4000K, IP21
METAL



③ 1776-1C

D112*H85
1*LED*12W,
4000K, IP21
METAL



④ 1777-1C

D75*H53
1*LED*5W,
4000K, IP21
METAL



⑤ 1778-1C

D87*H60
1*LED*7W,
4000K, IP21
METAL



⑥ 1779-1C

D112*H85
1*LED*12W,
4000K, IP21
METAL



* BROWN PAINTED FRAME.
АРМАТУРА КОРИЧНЕВОГО ЦВЕТА.
* BLOWN GLASS LAMPSHADE.
ВЫДУВНОЕ СТЕКЛО.

①



IP44 HUNT



① **1849-1W**

W530*D260*H340
1*E27*60W
METAL, GLASS,
GYPSUM



② **1848-1W**

W480*D190*H440
1*E27*60W
METAL, GLASS,
GYPSUM



③ **1847-1W**

W360*D240*H250
1*E27*60W
METAL, GLASS,
GYPSUM



②



③



FIREFOX



* GRAPHIT COLOR PAINTED FRAME.
АРМАТУРА ГРАФИТОВОГО ЦВЕТА.

①



* BLACK COLOR PAINTED FRAME,
АРМАТУРА ЧЕРНОГО ЦВЕТА.
* GLASS WITH DIAMOND CUT GLASS,
СТЕКЛО С АЛМАЗНОЙ ОГРАНКОЙ.

②



① **1821-1W**

W187*D175*H131
● 1*LED*6W
METAL, ACRYL



② **1822-1W**

W116*D112*H238
● 1*E27*60W
METAL, GLASS



③ **1803-1W**

W160*D215*H550
● 1*E27*60W
METAL, GLASS



FACKEL



* BLACK-GOLD COLOR PAINTED FRAME,
АРМАТУРА ЧЕРНОГО ЦВЕТА С ЗОЛОТОЙ ПАТИНОЙ.
* MATT WHITE BLOWN GLASS,
ПЛАФОН ИЗ БЕЛОГО МАТОВОГО ВЫДУВНОГО СТЕКЛА.

③





* BLACK PAINTED METAL FRAME.
АРМАТУРА ЧЕРНОГО ЦВЕТА.
* WHITE MATT GLASSES..
БЕЛЫЕ МАТОВЫЕ СТЕКЛА.



IP44



③

PROVINZ



① **1820-2F**
680*260*2090
2*E27*60W
METAL, GLASS



② **1820-1W**
241*190*340
1*E27*60W
METAL, GLASS



③ **1820-1F**
335*190*1250
1*E27*60W
METAL, GLASS









* BLACK PAINTED METAL FRAME,
АРМАТУРА ЧЕРНОГО ЦВЕТА.
* SEMITRANSSPARENT FROSTED GLASS DIFFUSER,
ПОЛУПРОЗРАЧНОЕ СТЕКЛО С ЭФФЕКТОМ ЛЬДА.

IP44 COLOSSO



MOTION SENSOR
ДАТЧИК ДВИЖЕНИЯ

	① 1819-1W D220*W180*H315 1*E27*60W METAL, GLASS
	② 1817-1W D220*W180*H315 1*E27*60W METAL, GLASS,
	③ 1818-1W D220*W180*H315 1*E27*60W METAL, GLASS,
	④ 1817-2F W600*L260*H2150 2*E27*60W METAL, GLASS
	⑤ 1817-1F W180*L180*H1050 1*E27*60W METAL, GLASS
	⑥ 1817-1T W180*L180*H420 1*E27*60W METAL, GLASS





* BLACK-GOLD PAINTED METAL FRAME,
АРМАТУРА ЧЕРНОГО ЦВЕТА С ЗОЛОТОЙ ПАТИНОЙ.
* FROSTED GLASS DIFFUSER WITH INSET
GLASS COGNAC COLOR,
ПОЛУПРОЗРАЧНОЕ СТЕКЛО С ЭФФЕКТОМ ЛЬДА И
ВСТАВКОЙ ИЗ СТЕКЛА КОНЬЯЧНОГО ЦВЕТА.

IP44 ZAGREB

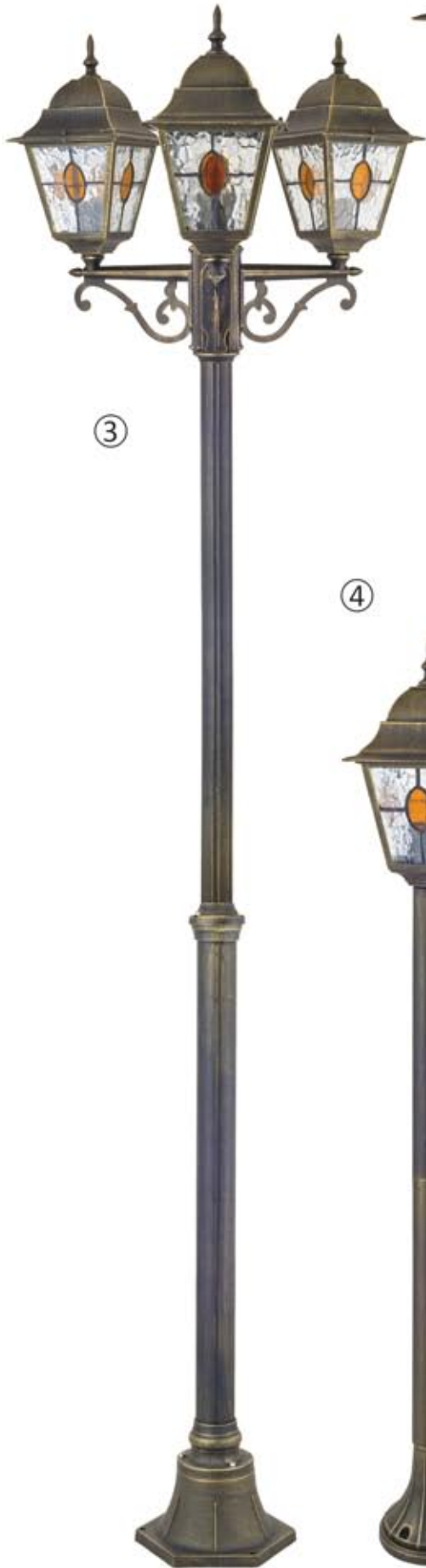

① 1804-1P

W180*L180*H980
1*E27*100W
METAL, GLASS



② 1804-1W

D250*W180*H450
1*E27*100W
METAL, GLASS,



③ 1804-3F

D610*H2080
3*E27*100W
METAL, GLASS,



④ 1804-1F

W180*L180*H935
1*E27*100W
METAL, GLASS



⑤ 1805-1W

D250*W180*H450
1*E27*100W
METAL, GLASS,



⑥ 1805-1T

W180*L180*H450
1*E27*100W
METAL, GLASS





* BLACK METAL FRAME WITH GREEN PATINA (BRONZE OXIDATION EFFECT),
 АРМАТУРА ЧЕРНОГО ЦВЕТА С ЗЕЛЕНОЙ ПАТИНОЙ
 (С ЭФФЕКТОМ БРОНЗОВОГО ОКИСЛЕНИЯ).
 * TRANSPARENT GLASS DIFFUSER.
 РАССЕИВАТЕЛЬ ИЗ ПРОЗРАЧНОГО СТЕКЛА.

IP44

PARIS



① **1806-1P**
 D170*H1015
 1*E27*100W
 METAL, GLASS



② **1807-1W**
 D250*W170*H500
 1*E27*100W
 METAL, GLASS



③ **1806-1W**
 D250*W170*H500
 1*E27*100W
 METAL, GLASS



④ **1806-3F**
 D600*H2250
 3*E27*100W
 METAL, GLASS



⑤ **1806-1F**
 D170*H1250
 1*E27*100W
 METAL, GLASS



⑥ **1806-1T**
 D170*H500
 1*E27*100W
 METAL, GLASS



①

IP44



②



③



LONDON



① **1811-1W**
 D285*W205*H515
 1*E27*100W
 METAL, GLASS



② **1810-1W**
 D285*W205*H515
 1*E27*100W
 METAL, GLASS



③ **1810-1F**
 D230*H1250
 1*E27*100W
 METAL, GLASS



* BLACK-SILVER PAINTED METAL FRAME,
 АРМАТУРА ЧЕРНОГО ЦВЕТА С
 СЕРЕБРЯНОЙ ПАТИНОЙ.
 * CLEAR GLASS DIFFUSOR,
 РАССЕЙВАТЕЛЬ ИЗ ПРОЗРАЧНОГО СТЕКЛА.

IP44 LONDON



① **1808-1P**
D205*H1000
1*E27*100W
METAL, GLASS



② **1809-1W**
D285*W205*H515
1*E27*100W
METAL, GLASS,



③ **1808-1W**
D285*W205*H515
1*E27*100W
METAL, GLASS,



④ **1808-3F**
D600*H2250
3*E27*100W
METAL, GLASS



⑤ **1808-1F**
D230*H1250
1*E27*100W
METAL, GLASS



⑥ **1808-1T**
D205*H515
1*E27*100W
METAL, GLASS



* BLACK- GOLD PAINTED METAL FRAME,
АРМАТУРА ЧЕРНОГО ЦВЕТА С
ЗОЛОТОЙ ПАТИНОЙ.
* CLEAR GLASS DIFFUSOR,
РАССЕИВАТЕЛЬ ИЗ ПРОЗРАЧНОГО СТЕКЛА.



IP44

LEON



① **1812-1P**
D150*H700
1*E27*60W
METAL, GLASS



② **1813-1W**
D205*W150*H330
1*E27*60W
METAL, GLASS



③ **1812-1W**
D205*W150*H330
1*E27*60W
METAL, GLASS



④ **1812-1T**
D150*D400
1*E27*60W
METAL, GLASS



⑤ **1812-1F**
D150*D810
1*E27*60W
METAL, GLASS



* BLACK PAINTED METAL FRAME,
АРМАТУРА ЧЕРНОГО ЦВЕТА.
* CLEAR GLASS DIFFUSOR,
РАССЕИВАТЕЛЬ ИЗ ПРОЗРАЧНОГО СТЕКЛА.



①



②



③



⑤



④

IP44

LEON



① **1814-1P**
D150*H700
1*E27*60W
METAL, GLASS



② **1815-1W**
D205*W150*H330
1*E27*60W
METAL, GLASS



③ **1814-1W**
D205*W150*H330
1*E27*60W
METAL, GLASS



④ **1814-1T**
D150*D400
1*E27*60W
METAL, GLASS



⑤ **1814-1F**
D150*D810
1*E27*60W
METAL, GLASS



* WHITE PAINTED METAL FRAME,
АРМАТУРА БЕЛОГО ЦВЕТА.
* CLEAR GLASS DIFFUSOR,
РАССЕИВАТЕЛЬ ИЗ ПРОЗРАЧНОГО СТЕКЛА.



* ALUMINIUM COLOR METAL FRAME,
АРМАТУРА АЛЮМИНИЕВОГО ЦВЕТА.
* LIGHT BEAM ADJUSTABLE,
ПЛАФОН С ПОВОРОТНЫМ МЕХАНИЗМОМ..



①

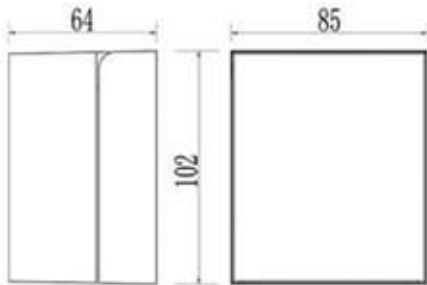

②

MOTION SENSOR
ДАТЧИК ДВИЖЕНИЯ

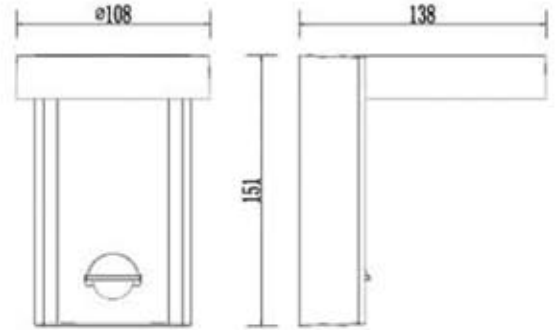

③

IP44/65

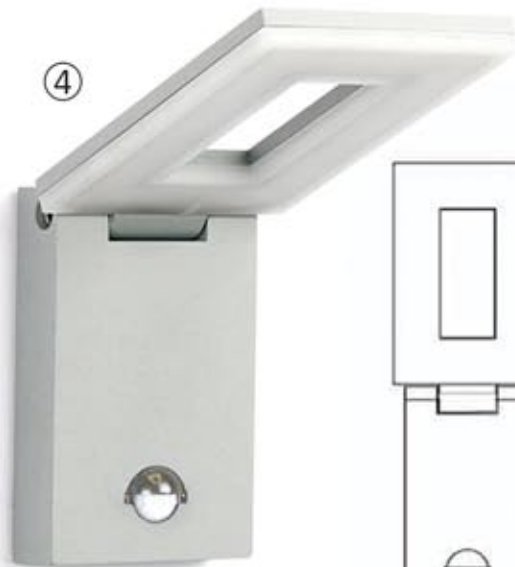
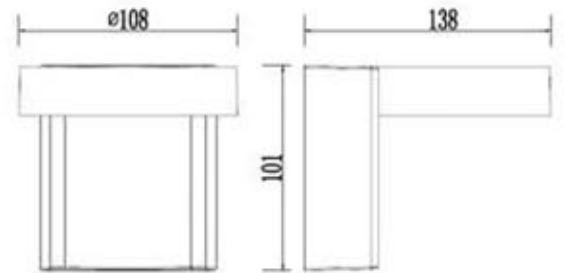

④

MOTION SENSOR
ДАТЧИК ДВИЖЕНИЯ

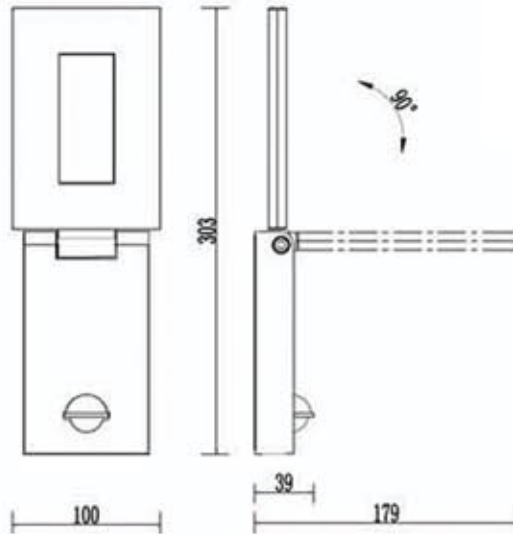

FLICKER



⑤

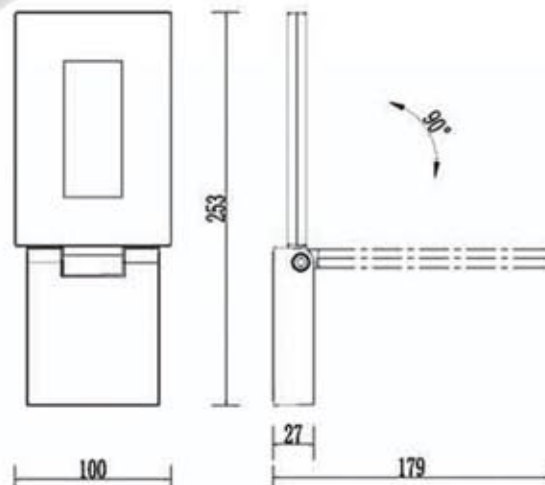

① **1823-1W**
W85*D64*H102
● LED*10W
4000K IP65
METAL, GLASS



② **1827-1W**
W108*D138*H151
● LED*10W
4000K IP44
METAL, GLASS



③ **1826-1W**
W108*D138*H101
● LED*10W
4000K IP65
METAL, GLASS



④ **1825-1W**
W100*D179*H303
● LED*10W
4000K IP44
METAL, ACRYL



⑤ **1824-1W**
W100*D179*H253
● LED*10W
4000K IP65
METAL, ACRYL



* WHITE OR BLACK COLOR METAL FRAME,
 ЧЕРНОГО ИЛИ БЕЛОГО ЦВЕТОВ.
 * GU10 BULBS ARE NOT INCLUDED.
 ЛАМПИ GU10 НЕ ВХОДЯТ В КОМПЛЕКТ.



①



③



②



④

IP44/65

FLICKER



① **1828-2W**
 W78*D97*H170
 ● 2*LED*9W
 4000K, IP65
 METAL, GLASS



② **1829-2W**
 W58*D74*H128
 ● 2*LED*3W
 4000K, IP65
 METAL, GLASS



③ **1830-1W**
 W108*D138*H101
 ♡ 1*GU10LED*6W
 4000K, IP44
 METAL, GLASS



④ **1830-2W**
 W102*D132*H180
 ♡ 2*GU10LED*6W
 4000K, IP44
 METAL, GLASS



⑤ **1830-1U**
 D102*H104
 ♡ 1*GU10LED*6W
 4000K, IP44
 METAL, GLASS



⑤



* BLACK PAINTED METAL FRAME,
АРМАТУРА ЧЕРНОГО ЦВЕТА.
* TEMPERED GLASS DIFFUSOR,
РАССЕИВАТЕЛЬ ИЗ ЗАКАЛЕННОГО СТЕКЛА,
* GU10 BULBS ARE NOT INCLUDED.
ЛАМПЫ GU10 НЕ ВХОДЯТ В КОМПЛЕКТ.

①



②



③

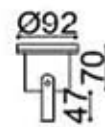

TEMPERED GLASS
ЗАКАЛЕННОЕ СТЕКЛО

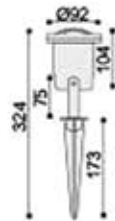
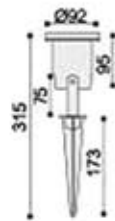

④

⑤

IP65 RELIEF

- ① **1832-1W**
D92*H126
1*GU10*50W
METAL, GLASS
- ② **1831-1W**
D92*H126
1*GU10*50W
METAL, GLASS
- ③ **1816-1T**
D115*H300/476
1*GU10*50W
METAL, GLASS
- ④ **1834-1T**
D92*H248/324
1*GU10*50W
METAL, GLASS
- ⑤ **1833-1T**
D92*H248/324
1*GU10*50W
METAL, GLASS

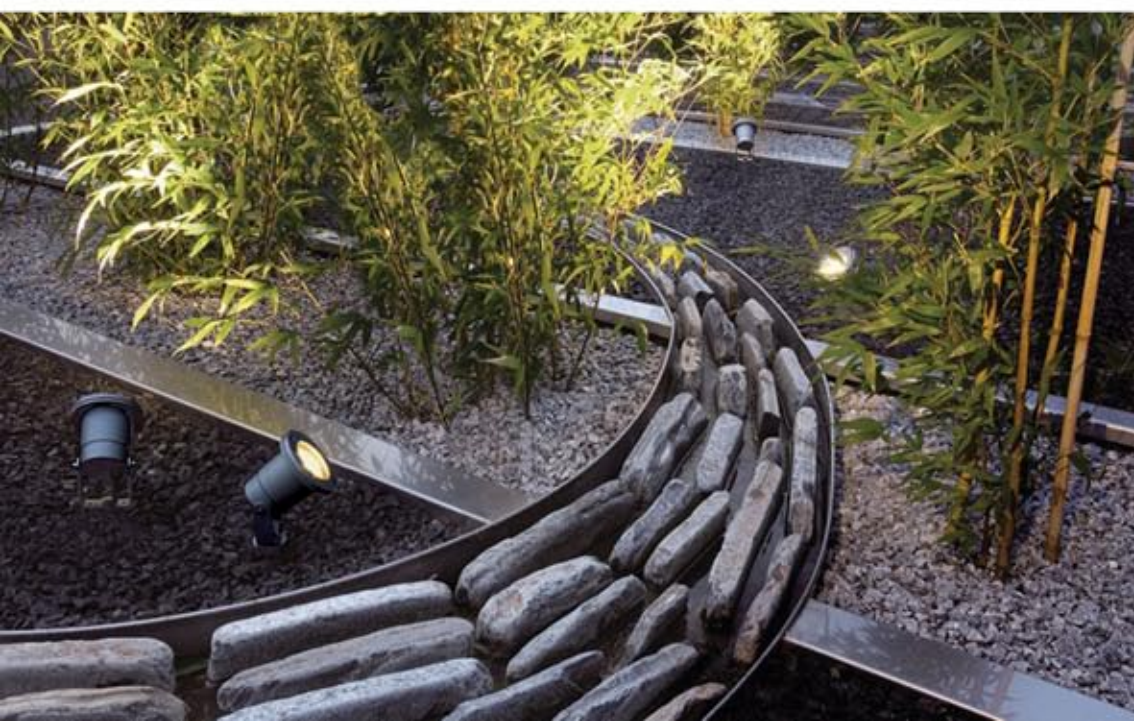

INDEX

артикул	страница каталога	fastening/крепление
1692-1W	50	
1729-1W	4	
1729-2W	4	
1729-5P	4	hook/крюк
1729-7P	3	hook/крюк
1730-1W	5	
1730-2W	5	
1730-5P	5	hook/крюк
1730-7P	5	hook/крюк
1731-1W	6	
1731-2W	6	
1731-5P	6	hook/крюк
1731-7P	6	hook/крюк
1732-1W	7	
1732-2W	7	
1732-5P	7	hook/крюк
1732-8P	7	hook/крюк
1733-1W	9	
1733-2W	9	
1733-5P	9	hook/крюк
1733-7P	9	hook/крюк
1734-1W	8	
1734-2W	8	
1734-5P	8	hook/крюк
1734-7P	8	hook/крюк
1735-10P	18	hook/крюк
1735-12P	17	hook/крюк
1735-1W	17	
1735-2W	17	
1735-5P	18	hook/крюк
1735-8P	18	hook/крюк
1736-12P	19	hook/крюк
1736-1W	20	
1736-2W	20	
1736-6P	20	hook/крюк
1736-8P	20	hook/крюк
1737-2W	22	
1737-5P	22	hook/крюк
1737-8P	21	hook/крюк
1738-12P	15	hook/крюк
1738-1W	16	
1738-2W	16	
1738-5P	16	hook/крюк
1738-8P	16	hook/крюк

артикул	страница каталога	fastening/крепление
1739-9P	36	strip/планка
1739-9U	36	strip/планка
1740-9P	36	strip/планка
1740-9U	36	strip/планка
1741-2P	39	strip/планка
1741-6P	39	strip/планка
1741-8P	40	strip/планка
1742-2P	39	strip/планка
1742-6P	39	strip/планка
1742-8P	40	strip/планка
1743-2P	39	strip/планка
1743-6P	39	strip/планка
1743-8P	40	strip/планка
1744-5P	23	hook/крюк
1745-5P	24	hook/крюк
1746-5P	24	hook/крюк
1747-1PC	53	strip/планка
1748-12U	42	strip/планка
1748-6U	41	strip/планка
1748-8U	41	strip/планка
1749-12U	42	strip/планка
1749-6U	41	strip/планка
1749-8U	41	strip/планка
1750-1W	27	
1750-6P	27	strip/планка
1750-9P	27	strip/планка
1751-1W	28	
1751-6P	28	strip/планка
1751-9P	28	strip/планка
1752-1P	53	strip/планка
1753-1P	53	strip/планка
1754-15P	44	strip/планка
1754-6P	44	strip/планка
1755-15P	43	strip/планка
1755-6P	44	strip/планка
1756-1W	59	
1756-5U	59	strip/планка
1757-1W	45	
1757-6P	45	strip/планка
1757-9P	45	strip/планка
1758-1W	46	
1758-6P	46	strip/планка
1758-9P	46	strip/планка
1760-1P	26	strip/планка

INDEX

артикул	страница каталога	fastening/ крепление
1760-3P	26	strip/планка
1761-1U	51	strip/планка
1761-1W	51	
1762-1P	51	strip/планка
1762-2P	51	strip/планка
1763-2W	25	
1763-5P	25	hook/крюк
1763-8P	25	hook/крюк
1764-10P	47	strip/планка
1764-18P	47	strip/планка
1764-4P	47	strip/планка
1764-6P	47	strip/планка
1765-10P	48	strip/планка
1765-18P	48	strip/планка
1765-4P	48	strip/планка
1765-6P	48	strip/планка
1766-1U	61	strip/планка
1767-1U	61	strip/планка
1768-1U	61	strip/планка
1769-1U	61	strip/планка
1770-1U	61	strip/планка
1771-1U	61	strip/планка
1772-1U	61	strip/планка
1773-1U	61	strip/планка
1774-1C	62	strip/планка
1775-1C	62	strip/планка
1776-1C	62	strip/планка
1777-1C	62	strip/планка
1778-1C	62	strip/планка
1779-1C	62	strip/планка
1780-18P	49	strip/планка
1780-1W	49	
1780-3P	50	strip/планка
1780-6P	50	strip/планка
1780-8P	50	strip/планка
1781-1P	53	strip/планка
1782-4U	23	strip/планка
1783-1P	54	strip/планка
1783-1W	54	
1783-6P	54	strip/планка
1784-1W	54	
1785-1P	55	strip/планка
1785-1U	55	
1785-1W	55	

артикул	страница каталога	fastening/ крепление
1785-3P	55	strip/планка
1786-2W	26	
1787-2W	26	
1788-1P	56	strip/планка
1788-1W	56	
1788-2P	56	strip/планка
1788-4P	56	strip/планка
1789-1W	56	
1789-4P	56	strip/планка
1790-1P	57	strip/планка
1791-1P	57	strip/планка
1792-1P	57	strip/планка
1793-1P	58	strip/планка
1793-1W	58	
1793-5P	58	strip/планка
1794-1W	29	
1794-2U	29	
1794-3U	29	
1794-4U	29	
1795-1W	29	
1795-2U	29	
1795-3U	29	
1795-4U	29	
1796-1W	30	
1796-2U	30	
1796-3U	30	
1797-1W	30	
1797-2U	30	
1797-3U	30	
1798-1W	31	
1798-2U	31	
1798-3U	31	
1798-4U	31	
1799-1W	31	
1799-2U	31	
1799-3U	31	
1799-4U	31	
1800-1P	33	strip/планка
1800-3P	33	strip/планка
1801-1P	32	strip/планка
1801-1P1	32	strip/планка
1801-1W	32	
1802-1P	34	strip/планка
1802-4P	34	strip/планка

INDEX

артикул	страница каталога	fastening/ крепление
1803-1W	64	
1804-1F	67	
1804-1P	67	hook/крюк
1804-1W	67	
1804-3F	67	
1805-1T	67	
1805-1W	67	
1806-1F	68	
1806-1P	68	hook/крюк
1806-1T	68	
1806-1W	68	
1806-3F	68	
1807-1W	68	
1808-1F	70	
1808-1P	70	
1808-1T	70	
1808-1W	70	
1808-3F	70	
1809-1W	70	
1810-1F	69	
1810-1W	69	
1811-1W	69	
1812-1F	71	
1812-1P	71	hook/крюк
1812-1T	71	
1812-1W	71	
1813-1W	71	
1814-1F	72	
1814-1P	72	hook/крюк
1814-1T	72	
1814-1W	72	
1815-1W	72	
1816-1T	75	
1817-1F	66	
1817-1T	66	
1817-1W	66	
1817-2F	66	
1818-1W	66	
1819-1W	66	
1820-1F	65	
1820-1W	65	
1820-2F	65	
1821-1W	64	
1822-1W	64	

артикул	страница каталога	fastening/ крепление
1823-1W	73	
1824-1W	73	
1825-1W	73	
1826-1W	73	
1827-1W	73	
1828-2W	74	
1829-2W	74	
1830-1U	74	
1830-1W	74	
1830-2W	74	
1831-1W	75	
1832-1W	75	
1833-1T	75	
1834-1T	75	
1834-3P	52	hook/крюк
1834-5P	52	hook/крюк
1835-1W	11	
1835-5P	11	hook/крюк
1835-7P	11	hook/крюк
1836-1T	12	
1836-2W	12	
1836-5P	12	hook/крюк
1836-7P	12	hook/крюк
1837-2W	10	
1837-6P	10	hook/крюк
1837-8P	10	hook/крюк
1838-1W	13	
1838-5P	13	hook/крюк
1838-7P	13	hook/крюк
1839-1W	14	
1839-5P	14	hook/крюк
1839-7P	14	hook/крюк
1840-6P	37	strip/планка
1841-6P	37	strip/планка
1842-6P	38	strip/планка
1843-6P	38	strip/планка
1844-1P	60	strip/планка
1845-1P	60	strip/планка
1846-1P	60	strip/планка
1846-3P	60	strip/планка
1847-1W	63	
1848-1W	63	
1849-1W	63	



WWW.FAVOURITE-LIGHT.COM

