



Catalogue **2017**







## Vorwort

### **Liebe Kundin, lieber Kunde,**

die Brilliant AG hatte sich auch für den Katalog 2017 erneut dem Anspruch gestellt, gutes Licht für mehr Lebensqualität zu schaffen.

Dazu gehört unter anderem die optische Aufwertung des eigenen Zuhauses mit Leuchten, die die aktuellen Trends aufgreifen. Ob nun der klassische, glamouröse, extravagante oder natürliche Wohnstil bevorzugt wird, unter unseren Produkten befindet sich mit Sicherheit das passende Design.

Die richtige Leuchten-Auswahl ist aber nicht nur Geschmackssache, - mit der energieeffizienten LED-Technik unserer Produkte werden neben Ästhetik und Funktion auch Lichtqualität und ein ökologischer Aspekt mit berücksichtigt.

Last but not least, mit unserem EASYDIM LED Konzept bieten wir Ihnen eine echte technologische Innovation.

Aber überzeugen Sie sich selbst und lassen sich inspirieren. Wir wünschen Ihnen dabei viel Vergnügen.

**Ihr Thorsten A. Spengler**



## Foreword

### **Dear Customer,**

For the 2017 catalogue Brilliant AG has once again made the claim to provide good light for more quality of life.

Among other things, this includes the visual enhancement of one's own home with lights which take up current trends. Whether the classic, glamorous, extravagant or natural home style is now preferred, you will certainly find the suitable design among our products.

But the right choice of lights is not only a matter of taste. In addition to aesthetics and function, quality of light and an ecological aspect is also taken into consideration with the energy-efficient LED technology utilised in our products.

Last but not least, with our EASYDIM LED concept we offer you a real technological innovation.

But convince yourself and be inspired. We wish you lots of fun in the process.

**Yours truly,  
Thorsten A. Spengler**



## Préface

### **Chère cliente, cher client,**

Pour le catalogue 2017, la société Brilliant AG s'était de nouveau fixé pour exigence de créer de la bonne lumière pour une meilleure qualité de vie.

En fait, entre autres, partie la revalorisation optique de nos propres boîtiers avec des lampes qui suivent la tendance actuelle. Que vous préféreriez un style de vie classique, glamour, extravagant ou naturel, vous trouverez sans aucun doute le design adéquat parmi nos produits.

Le juste choix des lampes n'est cependant pas qu'une affaire de goût. Avec la technologie LED économe en énergie de nos produits, vous prenez également en compte la qualité de la lumière et l'aspect écologique, en plus de l'esthétique et du fonctionnement. Le meilleur pour la fin : avec notre concept EASYDIM LED, nous vous proposons une véritable innovation technologique.

Venez voir par vous-mêmes et laissez-vous inspirer.  
Nous vous souhaitons beaucoup de plaisir.

**Votre Thorsten A. Spengler**



## Prefacio

### **Estimados clientes,**

Brilliant AG se ha propuesto de nuevo generar una buena luz que aporte una mayor calidad de vida en su catálogo 2017.

Entre otros factores, esto pasa por la revalorización óptica de la propia vivienda a través de las luces, inspiradas en las últimas tendencias. En nuestra gama de productos encontrará con total seguridad el diseño adecuado, sea cual sea su estilo preferido: clásico, glamuroso, extravagante o natural.

Elegir unas luces adecuadas no es solo una cuestión de estilo. Gracias a la eficiente tecnología LED de nuestros productos no solo se tienen en cuenta la estética y la funcionalidad, sino también la calidad de la luz y el factor ecológico.

Finalmente, pero no por ello menos importante, le presentamos nuestro concepto EASYDIM LED, una verdadera innovación tecnológica.

Compruébelo usted mismo y deje que le inspiremos.  
Esperamos que lo disfrute.

**Thorsten A. Spengler**



## Prefazione

### **Cara cliente, caro cliente,**

anche per il catalogo 2017 Brilliant AG si era nuovamente data il grande obiettivo di creare buona luce per aumentare la qualità della vita.

Questo obiettivo comprende tra l'altro la rivalorizzazione ottica della vostra casa con luci che abbracciano le tendenze attuali. Che poi si preferisca per la propria abitazione uno stile classico, glamour, stravagante o naturale, tra i nostri prodotti si trova di certo il design adatto.

La scelta delle luci giuste, però, non è solo una questione di gusti: con la tecnologia a LED dei nostri prodotti, efficiente dal punto di vista energetico, oltre a estetica e funzionalità si tengono in considerazione anche la qualità della luce e un aspetto ecologico.

E poi, ultimo ma non per importanza, con il nostro concetto EASYDIM LED vi offriamo una vera innovazione tecnologica.

Ma convincetevi voi stessi, e lasciatevi ispirare.  
Vi auguriamo buon divertimento.

**Vostro Thorsten A. Spengler**



## предисловие

### **Уважаемый клиент!**

Компания «Бриллиант АГ» в каталоге 2017 снова поставила себе целью создать хорошее освещение для лучшего качества жизни.

Сюда относится, в том числе, повышение визуальной привлекательности домашнего интерьера благодаря светильникам, соответствующим актуальным трендам. И какой бы стиль Вы ни предпочли в обустройстве вашего жилья - классику, гламур, экстравагантность или естественность, - среди нашей продукции непременно найдется подходящий дизайн.

Однако правильный выбор светильника – это не только дело вкуса; в энергосберегающих светодиодных технологиях нашей продукции наряду с эстетикой и функциональностью учтены также качество освещения и экологический аспект.

И последнее, но не менее важное, предлагаемая нами концепция EASYDIM LED является настоящей технологической инновацией.

Однако убедитесь же в этом сами и проникнитесь вдохновением! Желаем Вам получить огромное удовольствие!

**Ваш Торстен А. Шпенглер**

# CONTENT





## INTRODUCTION

- 01 INTRODUCTION
- 04 CONTENT
- 06 EASYDIM BULBS

## CATEGORIES

- 12 SPOTS
- 142 DECORATIVE
- 258 PENDANTS
- 358 WALL & CEILING
- 478 FLOOR LAMPS
- 516 TABLE LAMPS
- 590 RECESS
- 610 KIDS

## CONCEPTS

- 618 SOFTLINE
- 624 BRILLIANCE
- 630 NEO RETRO
- 634 INDUSTRIAL
- 638 WOOD
- 642 EASYDIM

## TECHNICAL DETAILS / INDEX

- 646 TECHNICAL DETAILS
- 652 TERMS / INDEX



## HELLIGKEIT LEICHT ÜBER DEN LICHTSCHALTER STEUERN

- Patentierte Lichttechnik
- Stufenlos dimmbar für ein individuelles Lichtambiente
- Kein extra Dimmer-Schalter benötigt
- Dimmt langsam auf ca. 10% Leuchtkraft herunter



Erfahren sie mehr über unsere LED Innovationen unter:

[www.brilliant-ag.de](http://www.brilliant-ag.de)



E14  
Candle

E14  
Reflector

E27 G95  
Globe

E14 R50  
Miniglobe

E27 A60  
Ambience

GU10 SMD  
Reflector

**DIMMABLE WITH  
EVERY CONVENTIONAL  
LIGHT SWITCH**

**TRANSFORME TOUS  
LES INTERRUPTEURS  
HABITUELS EN  
VARIATEURS DE LUMIERE**

**DIMMERABILE  
CON QUALSIASI  
INTERRUPTORE DELLA  
LUCHE TRADIZIONALE**



## **EASY DIMMING WITH YOUR CONVENTIONAL LIGHTSWITCH**

- ▶ patented lighting technology
- ▶ infinitely dimmable for an individual lighting ambience
- ▶ no extra dim switch required
- ▶ dims down to about 10% luminosity



## **RÉGLER LA LUMINOSITÉ FACILEMENT AVEC L'INTERRUPTEUR**

- ▶ Technique d'éclairage brevetée
- ▶ La lumière se tamise en douceur pour un éclairage personnalisé
- ▶ Pas besoin d'installer de variateur de lumière
- ▶ L'intensité de l'éclairage se tamise lentement jusqu'à 10%



## **REGOLARE FACILMENTE LA LUMINOSITÀ MEDIANTE L'INTERRUPTORE DELLA LUCE**

- ▶ Tecnica d'illuminazione brevettata
- ▶ Dimmerabile in maniera continua per un ambiente luminoso personalizzato
- ▶ Non è necessario un ulteriore interruttore dimmer
- ▶ Lenta diminuzione dell'intensità luminosa a ca. 10%

**SEHEN SIE SICH DAS VIDEO AN / WATCH THE VIDEO HERE  
REGARDEZ LA VIDÉO / GUARDATE IL VIDEO**





## EASYDIM

EINFACHES DIMMEN MIT IHREM HERKÖMMLICHEN LICHTSCHALTER



## EASYDIM

EASY DIMMING WITH YOUR OWN COMMON LIGHT SWITCH



### SO FUNKTIONIERT'S

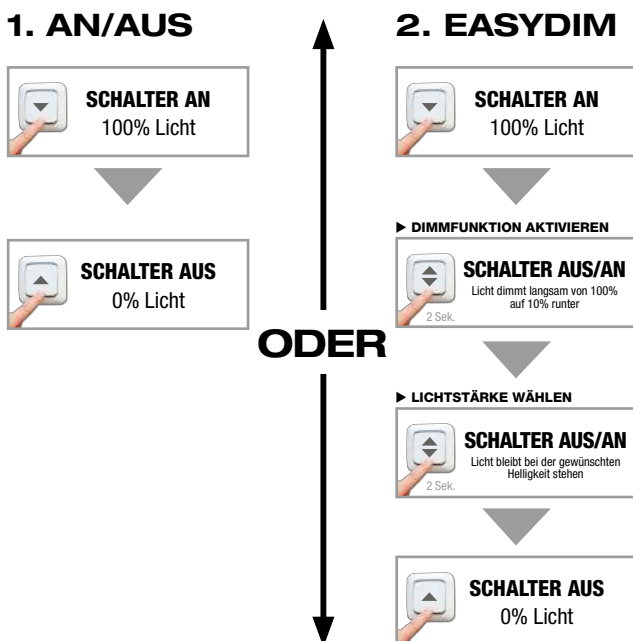

### THIS IS HOW IT WORKS

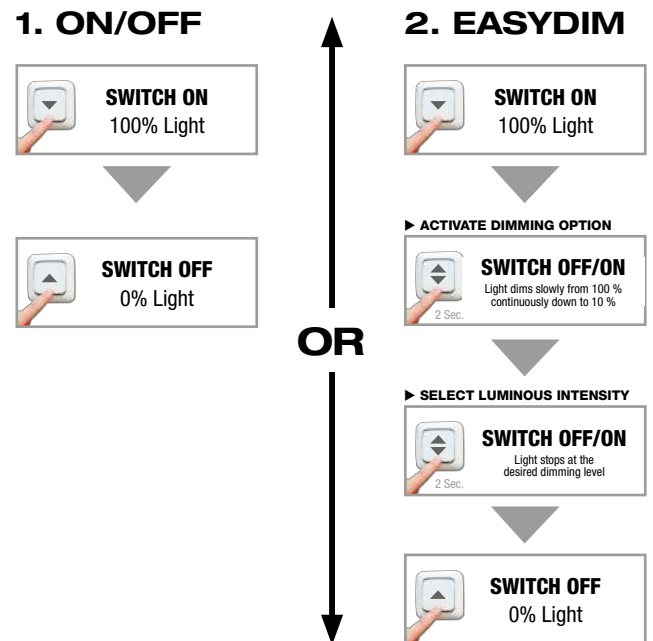



## EASYDIM

RÈGLEZ L'INTENSITÉ LUMINEUSE  
AVEC VOTRE INTERRUPTEUR.



## EASYDIM

FACILE REGOLAZIONE  
DELLA LUCE CON IL VOSTRO  
INTERRUTTORE TRADIZIONALE



### COMMENT ÇA MARCHE

#### 1. ON/OFF

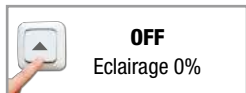

OU

#### 2. EASYDIM



► ACTIVEZ LA FONCTION VARIATEUR



► SÉLECTIONNEZ L'INTENSITÉ

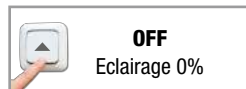

### FUNZIONA COSÌ

#### 1. ON/OFF



OR

#### 2. EASYDIM



► ATTIVA LA FUNZIONE DIMMER



► SELEZIONA L'INTENSITÀ



## E14 Candle



**A+**

ITEM NO.	DIMENSIONS (MM)	WATT	LUMEN	KELVIN	LIFETIME	CRI	EEC
96697/05	Ø 37 x 106	5 W	400 lm	3000 K	25000 h	CRI ≥ 80	A+



## E14 Miniglobe



**A+**

ITEM NO.	DIMENSIONS (MM)	WATT	LUMEN	KELVIN	LIFETIME	CRI	EEC
96698/05	Ø 45 x 80	5 W	400 lm	3000 K	25000 h	CRI ≥ 80	A+



## E27 Ambience



**A+**

ITEM NO.	DIMENSIONS (MM)	WATT	LUMEN	KELVIN	LIFETIME	CRI	EEC
96699/05	Ø 60 x 110	10 W	800 lm	3000 K	25000 h	CR I≥ 80	A+



## E27 Globe



**A+**

ITEM NO.	DIMENSIONS (MM)	WATT	LUMEN	KELVIN	LIFETIME	CRI	EEC
96700/05	Ø 95 x 139	12 W	960 lm	3000 K	25000 h	CRI ≥ 80	A+



## GU10 Reflector



**A+**

ITEM NO.	DIMENSIONS (MM)	WATT	LUMEN	KELVIN	LIFETIME	CRI	EEC
96701/05	Ø 50 x 58	5 W	400 lm	3000 K	25000 h	CRI ≥ 80	A+



## E14 Reflector



**A+**

ITEM NO.	DIMENSIONS (MM)	WATT	LUMEN	KELVIN	LIFETIME	CRI	EEC
96702/05	Ø 50 x 80	5 W	400 lm	3000 K	25000 h	CRI ≥ 80	A+







# SPOTS

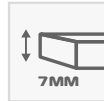

1-6



1-6

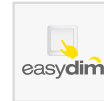

4-6



1-6

## Pluto

satin nickel/white  
metal/acrylic

### 1. G30510/13

↑ 110mm ↔ 110mm  
→ 145mm ø  
LED integr., 1 x 5W   
1 x 500 lm, 3000 K, **A+**



### 2. G30534/13

↑ 150mm ↔  
→ ø 220mm  
LED integr., 3 x 5W   
3 x 500 lm, 3000 K, **A+**



### 3. G30513/13

↑ 175 mm ↔ 315mm  
→ 110 mm ø  
LED integr., 2 x 5W   
2 x 500 lm, 3000 K, **A+**

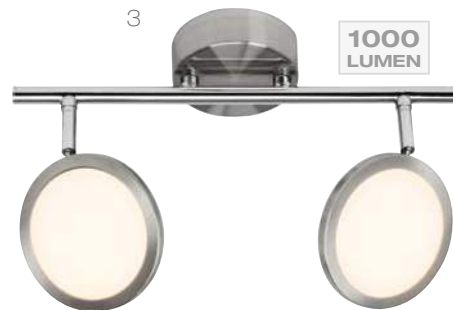

### 4. G30535/13

↑ 175mm ↔  
→ ø 280mm  
LED integr., 4 x 5W   
4 x 500 lm, 3000 K, **A+**



### 5. G30532/13

↑ 180mm ↔ 795mm  
→ 110mm ø  
LED integr., 4 x 5W   
4 x 500 lm, 3000 K, **A+**



### 6. G30506/13

↑ 200mm ↔ 1500mm  
→ 110mm ø  
LED integr., 6 x 5W   
6 x 500 lm, 3000 K, **A+**



SEE OTHER VERSIONS  
ON PAGE  
**360, 480**



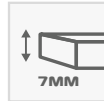

1-5



1-5

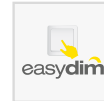

4-5



1-5

## Pluto

chrome/white  
metal/acrylic

### 1. G30510/15

↑ 110mm ↔ 110mm  
→ 145mm ø  
LED integr., 1 x 5W   
1 x 500 lm, 3000 K, **A+**



4 004353 249051

500  
LUMEN



2

1500  
LUMEN



### 2. G30534/15

↑ 150mm ↔  
→ ø 220mm  
LED integr., 3 x 5W   
3 x 500 lm, 3000 K, **A+**



4 004353 249075

1000  
LUMEN



3

### 3. G30513/15

↑ 175mm ↔ 315mm  
→ 110mm ø  
LED integr., 2 x 5W   
2 x 500 lm, 3000 K, **A+**



4 004353 249068

4



2000  
LUMEN



### 4. G30532/15

↑ 180mm ↔ 795mm  
→ 110mm ø  
LED integr., 4 x 5W   
4 x 500 lm, 3000 K, **A+**



4 004353 249082

### 5. G30506/15

↑ 200mm ↔ 1500mm  
→ 110mm ø  
LED integr., 6 x 5W   
6 x 500 lm, 3000 K, **A+**



4 004353 249099



3000  
LUMEN



5



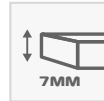

1-4



1-4

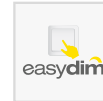

4



1-4

## Uranus

satin nickel/white metal/acrylic

### 1. G33810/13

↑ 145mm ↔ 110mm  
→ 145mm ø  
LED integr., 1 x 5W   
1 x 500 lm, 3000 K, **A+**



4 004353 249488

### 2. G33813/13

↑ 175mm ↔ 315mm  
→ 110mm ø  
LED integr., 2 x 5W   
2 x 500 lm, 3000 K, **A+**



4 004353 249495

### 3. G33816/13

↑ 175mm ↔ 550mm  
→ 110mm ø  
LED integr., 3 x 5W   
3 x 500 lm, 3000 K, **A+**



4 004353 249518

### 4. G33835/13

↑ 175mm ↔ 300mm  
→ 300mm ø  
LED integr., 4 x 5W   
4 x 500 lm, 3000 K, **A+**



4 004353 249532

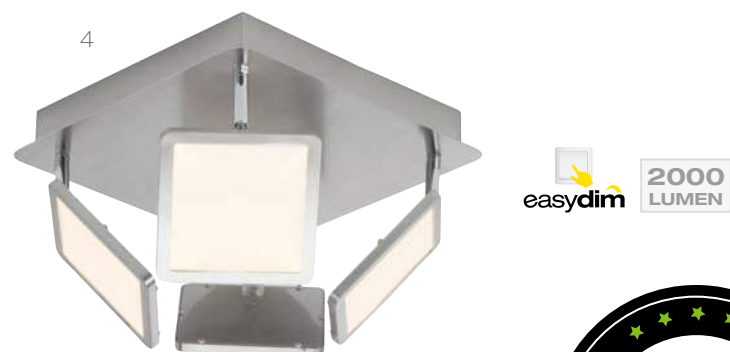
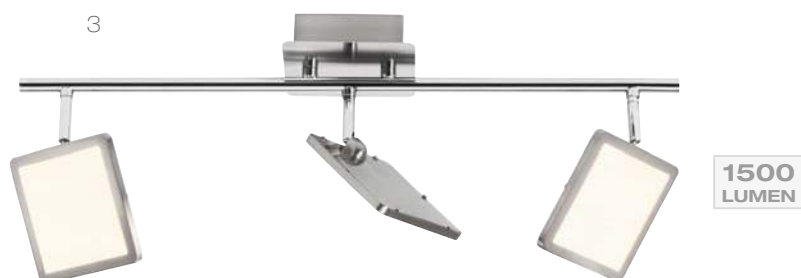

SEE OTHER VERSION  
ON PAGE  
**360**





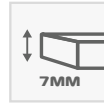

1-3



1-3

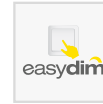

1-3



1-3

## Uranus

satin nickel/white metal/acrylic

### 1. G33832/13

↑ 180mm ↔ 795mm  
→ 120mm ø  
LED integr., 4 x 5W   
4 x 500 lm, 3000 K, **A+**



4 004353 249525

### 2. G33806/13

↑ 200mm ↔ 1500mm  
→ 110mm ø  
LED integr., 6 x 5W   
6 x 500 lm, 3000 K, **A+**



4 004353 249464

### 3. G33804/13

↑ 150mm ↔ 300mm  
→ 300mm ø  
LED integr., 4 x 5W   
4 x 500 lm, 3000 K, **A+**



4 004353 256479



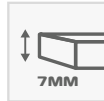

1-5



1-5

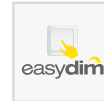

4-5



1-5

## Uranus

chrome/white  
metal/plastic

### 1. G33810/15

‡ 145mm ↔ 110mm  
→ 145mm ø  
LED integr., 1 x 5W   
1 x 500 lm, 3000 K, **A+**



4 004353 249372

500  
LUMEN



1000  
LUMEN

### 2. G33813/15

‡ 175mm ↔ 315mm  
→ 110mm ø  
LED integr., 2 x 5W   
2 x 500 lm, 3000 K, **A+**



4 004353 249402

3



1500  
LUMEN

### 3. G33816/15

‡ 175mm ↔ 550mm  
→ 110mm ø  
LED integr., 3 x 5W   
3 x 500 lm, 3000 K, **A+**



4 004353 249440

4



easydim 2000  
LUMEN

### 4. G33832/15

‡ 180mm ↔ 795mm  
→ 120mm ø  
LED integr., 4 x 5W   
4 x 500 lm, 3000 K, **A+**



4 004353 249457

### 5. G33806/15

‡ 200mm ↔ 1500mm  
→ 110mm ø  
LED integr., 6 x 5W   
6 x 500 lm, 3000 K, **A+**



4 004353 249341

easydim 3000  
LUMEN



5



SPOTS





1-4



1-4



1-4

## Torsion

chrome/white  
metal/acrylic

### 1. G32230/15

‡ 120mm ↔ 500mm  
→ 80mm ø  
LED integr., 3 x 6W   
3 x 650 lm, 3000 K, **A+**



### 2. G32229/15

‡ 120mm ↔ 300mm  
→ 80mm ø  
LED integr., 2 x 6W   
2 x 650 lm, 3000 K, **A+**



### 3. G32235/15

‡ 115mm ↔ 220mm  
→ 220mm ø  
LED integr., 4 x 6W   
4 x 650 lm, 3000 K, **A+**



### 4. G32210/15

‡ 110mm ↔ 100mm  
→ 100mm ø  
LED integr., 1 x 6W   
1 x 650 lm, 3000 K, **A+**





1-2



1-2

## Movable

chrome/white  
metal/acrylic

### 1. G94483/15

‡ 125mm ↔ 360mm  
→ 225mm ø  
LED integr., 4 x 5W   
4 x 300 lm, 3000 K, **A**   
↗ 98300/00

1200  
LUMEN



4 004353 250224



### 2. G94484/15

‡ 125mm ↔ 600mm  
→ 225mm ø  
LED integr., 6 x 5W   
6 x 300 lm, 3000 K, **A**   
↗ 98300/00



4 004353 250231



1800  
LUMEN





1 - 4



1 - 4



1 - 4

## Beauty

satin nickel/chrome/white  
metal/acrylic

### 1. G26131/77

↑ 150mm ↔ 590mm  
→ 155mm ø  
LED integr., 4 x 4W   
4 x 320 lm, 3000 K, **A+**  
↗ 98267/05, 98268/05



4 004353 247941



### 2. G26113/77

↑ 142mm ↔ 315mm  
→ 120mm ø  
LED integr., 2 x 4W   
2 x 320 lm, 3000 K, **A+**  
↗ 98267/05, 98268/05



4 004353 247927



### 3. G26133/77

↑ 150mm ↔  
→ ø 250mm  
LED integr., 3 x 4W   
3 x 320 lm, 3000 K, **A+**  
↗ 98267/05, 98268/05



4 004353 247934



### 4. G26110/77

↑ 120mm ↔ 115mm  
→ 120mm ø  
LED integr., 1 x 4W   
1 x 320 lm, 3000 K, **A+**  
↗ 98267/05, 98268/05



4 004353 247910







1-5



1-5



1-5

## Stairs

satin nickel/chrome/white  
metal/acrylic

### 1. G15206/77

↑ 75mm ↔ 1540mm  
→ 180mm ø  
LED integr., 6 x 4,5W   
6 x 360 lm, 3000 K,



4 004353 232800

### 2. G15232/77

↑ 180mm ↔ 772mm  
→ 75mm ø  
LED integr., 4 x 4,5W   
4 x 360 lm, 3000 K,



4 004353 232794

### 3. G15229/77

↑ 145mm ↔ 320mm  
→ 78mm ø  
LED integr., 2 x 4,5W   
2 x 360 lm, 3000 K,



4 004353 232770

### 4. G15234/77

↑ 145mm ↔  
→ ø 210mm  
LED integr., 3 x 4,5W   
3 x 360 lm, 3000 K,



4 004353 232787

### 5. G15210/77

↑ 85mm ↔  
→ 128mm ø 110mm  
LED integr., 1 x 4,5W   
1 x 360 lm, 3000 K,



4 004353 232763



2160  
LUMEN



1440  
LUMEN



720  
LUMEN



1080  
LUMEN



360  
LUMEN





1-4



1-4

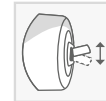

4

## Target

satin nickel/chrome/white metal / acrylic

### 1. G18830/77

‡ 100mm ↔ 390mm  
→ 120mm ø  
LED integr., 3 x 5W   
3 x 350 lm, 3000 K, **A+**



4 004353 239069

1050 LUMEN



### 2. G18829/77

‡ 100mm ↔ 280mm  
→ 120mm ø  
LED integr., 2 x 5W   
2 x 350 lm, 3000 K, **A+**



4 004353 239052



700 LUMEN

### 3. G18835/77

‡ 100mm ↔ 220mm  
→ 220mm ø  
LED integr., 4 x 5W   
4 x 350 lm, 3000 K, **A+**



4 004353 239076

3

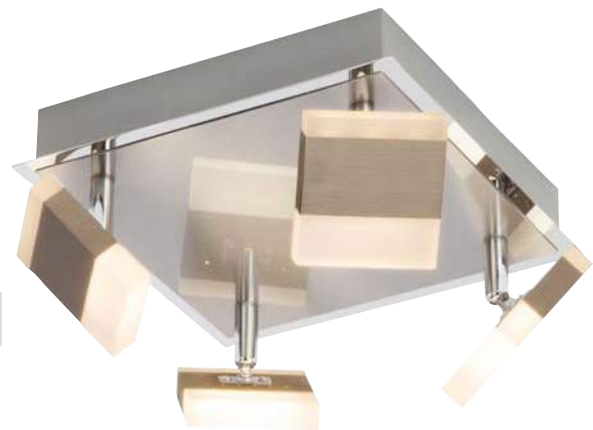

1400 LUMEN

### 4. G18810/77

‡ 130mm ↔ 95mm  
→ 115mm ø  
LED integr., 1 x 5W   
1 x 350 lm, 3000 K, **A+**



4 004353 239045

4



350 LUMEN







1-3



1-3

## Saturno

satin nickel/white  
metal/acrylic

### 1. G64732/13

↑ 150mm ↔ 800mm  
→ ∅  
LED integr., 4 x 4,5W   
4 x 400 lm, 3000 K, **A+**



4 004353 205873



1600  
LUMEN

### 2. G64713/13

↑ 140mm ↔ 400mm  
→ ∅  
LED integr., 2 x 4,5W   
2 x 400 lm, 3000 K, **A+**



4 004353 205866



800  
LUMEN

### 3. G64710/13

↑ ↔  
→ 140mm ∅ 100mm  
LED integr., 1 x 4,5W   
1 x 400 lm, 3000 K, **A+**



4 004353 205859



400  
LUMEN



**LED**  
incl.



1-3

1-3

## Shirin

chrome/white  
metal/plastic

### 1. G30132/15

↑ 150mm ↔ 700mm  
→ 150mm ø  
LED integr., 4 x 5W   
4 x 420 lm, 3000 K, **A+**



4 004353 192555



### 2. G30113/15

↑ 150mm ↔ 325mm  
→ 150mm ø  
LED integr., 2 x 5W   
2 x 420 lm, 3000 K, **A+**



4 004353 192548



### 3. G30110/15

↑ 130mm ↔  
→ 120mm ø 120mm  
LED integr., 1 x 5W   
1 x 420 lm, 3000 K, **A+**



4 004353 192531





1-3



1-3

## Plaxico

satin nickel/aluminium/white  
metal/acrylic

### 1. G30329/13

↑ 70mm ↔ 280mm  
→ 170mm ø  
LED integr., 2 x 5W   
2 x 420 lm, 3000 K, **A+**



4 004353 192586

### 2. G30335/13

↑ 170mm ↔ 220mm  
→ 220mm ø  
LED integr., 4 x 5W   
4 x 420 lm 3000 K, **A+**



4 004353 192579

### 3. G30310/13

↑ 130mm ↔ 95mm  
→ 170mm ø  
LED integr., 1 x 5W   
1 x 420 lm, 3000 K, **A+**



4 004353 192562



840  
LUMEN



1680  
LUMEN

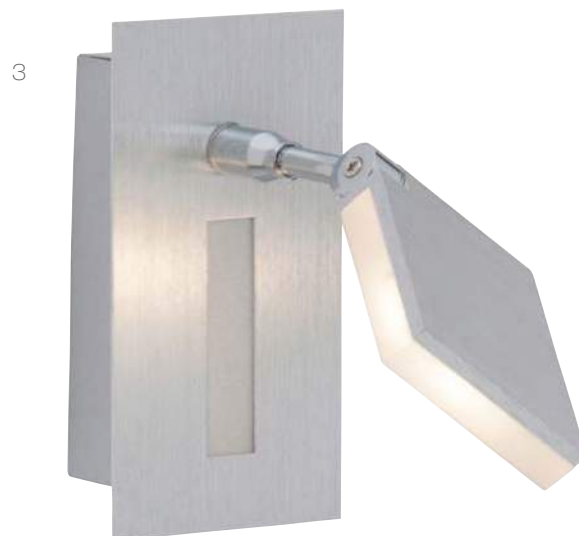

420  
LUMEN





1 - 4



1 - 4

## Lastra

chrome/transparent  
metal/glass

### 1. G38132/15

↓ 170mm ↔ 700mm  
→ ∅  
LED integr., 4 x 4,6W   
4 x 340 lm, 3000 K, **A+**



### 2. G38113/15

↓ 170mm ↔ 360mm  
→ ∅  
LED integr., 2 x 4,6W   
2 x 340 lm, 3000 K, **A+**



### 3. G38134/15

↓ 150mm ↔  
→ ∅ 200mm  
LED integr., 3 x 4,6W   
3 x 340 lm, 3000 K, **A+**



### 4. G38110/15

↓ 150mm ↔  
→ ∅ 80mm  
LED integr., 1 x 4,6W   
1 x 340 lm, 3000 K, **A+**





1 - 4



1 - 4

## Celest

chrome/transparent  
metal/glass

### 1. G21906/15

‡ 165mm ↔ 700mm  
→ 480mm ø  
LED integr., 6 x 5W   
6 x 350 lm, 3000 K, **A+**  
98228/00



4 004353 243363



2100  
LUMEN

### 2. G21932/15

‡ 170mm ↔ 680mm  
→ 205mm ø  
LED integr., 4 x 5W   
4 x 350 lm, 3000 K, **A+**  
98228/00



4 004353 243356



1400  
LUMEN

### 3. G21913/15

‡ 150mm ↔ 350mm  
→ 180mm ø  
LED integr., 2 x 5W   
2 x 350 lm, 3000 K, **A+**  
98228/00



4 004353 243349



700  
LUMEN

### 4. G21910/15

‡ 135mm ↔  
→ 170mm ø 150mm  
LED integr., 1 x 5W   
1 x 350 lm, 3000 K, **A+**  
98228/00



4 004353 243325



350  
LUMEN



1 - 4



1 - 4

## Rory

chrome/white  
metal/plastic

### 1. G35432/15

↑ 160mm ↔ 710mm  
→ ∅

LED integr., 4 x 5W   
4 x 320 lm, 2800 K,



4 004353 193613



1280  
LUMEN

### 2. G35416/15

↑ 160mm ↔ 475mm  
→ ∅

LED integr., 3 x 5W   
3 x 320 lm, 2800 K,



4 004353 193606



960  
LUMEN

### 3. G35413/15

↑ 160mm ↔ 275mm  
→ ∅

LED integr., 2 x 5W   
2 x 320 lm, 2800 K,



4 004353 193590

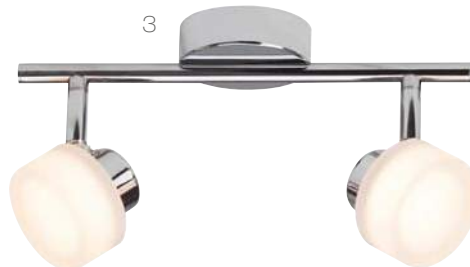

640  
LUMEN

### 4. G35410/15

↑ 130mm ↔  
→ ∅ 80mm

LED integr., 1 x 5W   
1 x 320 lm, 2800 K,



4 004353 193583



320  
LUMEN

SPOTS







1-3



1-3

## Narcissa

chrome/transparent  
metal/plastic

### 1. G34629/15

↑ 115mm ↔ 220mm  
→ 150mm ø  
LED integr., 2 x 5W   
2 x 400 lm, 3000 K, **A+**



4 004353 198137

### 2. G34635/15

↑ 150mm ↔ 220mm  
→ 220mm ø  
LED integr., 4 x 5W   
4 x 400 lm, 3000 K, **A+**



4 004353 198144

### 3. G34610/15

↑ 110mm ↔ 90mm  
→ 145mm ø  
LED integr., 1 x 5W   
1 x 400 lm, 3000 K, **A+**



4 004353 198120



800  
LUMEN



1600  
LUMEN



400  
LUMEN



1-3



1-3

## Heda

chrome/white  
metal/plastic

### 1. G36832/77

↑ 110mm ↔ 850mm  
→ 90mm ø  
LED integr., 4 x 4W   
4 x 400 lm, 3000 K, **A+**  
↗98209/77



4 004353 192678



1600  
LUMEN

### 2. G36813/77

↑ 160mm ↔ 300mm  
→ 90mm ø  
LED integr., 2 x 4W   
2 x 400 lm, 3000 K, **A+**  
↗98209/77



4 004353 192661



800  
LUMEN

### 3. G36810/77

↑ 160mm ↔  
→ ø 80mm  
LED integr., 1 x 4W   
1 x 400 lm, 3000 K, **A+**  
↗98209/77



4 004353 192654



400  
LUMEN



1-3



1-3

## Opalina

satin nickel/white  
metal/glass

### 1. G07131/77

‡ 135mm ↔ 780mm  
→ 225mm ø  
LED integr., 4 x 4W   
4 x 320 lm, 3000 K, **A+**  
↗98108/05

1280  
LUMEN



### 2. G07116/77

‡ 130mm ↔ 590mm  
→ 220mm ø  
LED integr., 3 x 4W   
3 x 320 lm, 3000 K, **A+**  
↗98108/05

960  
LUMEN



### 3. G07110/77

‡ 120mm ↔  
→ 210mm ø 120mm  
LED integr., 1 x 4W   
1 x 320 lm, 3000 K, **A+**  
↗98108/05

320  
LUMEN





1-3



1-3

## Zoey

chrome/white  
metal/glass

### 1. G57532/75

‡ 135mm ↔ 810mm  
→ 190mm ø  
LED integr., 4 x 4W   
4 x 280 lm, 2700 K, **A+**  
98186/05



### 2. G57513/75

‡ 125mm ↔ 380mm  
→ 175mm ø  
LED integr., 2 x 4W   
2 x 280 lm, 2700 K, **A+**  
98186/05



### 3. G57510/75

‡ 105mm ↔  
→ 160mm ø  
LED integr., 1 x 4W   
1 x 280 lm, 2700 K, **A+**  
98186/05





## More

chrome  
metal/plastic

### 1. G13632/15

‡ 110mm ↔ 795mm  
→ 140mm ø  
LED integr., 4 x 5W   
4 x 400 lm, 3000 K, **A+**



1600  
LUMEN

### 2. G13613/15

‡ 110mm ↔ 305mm  
→ 140mm ø  
LED integr., 2 x 5W   
2 x 400 lm, 3000 K, **A+**



800  
LUMEN

### 3. G13633/15

‡ 110mm ↔  
→ 140mm ø 250mm  
LED integr., 3 x 5W   
3 x 400 lm, 3000 K, **A+**



1200  
LUMEN

### 4. G13610/15

‡ 90mm ↔  
→ 120mm ø 90mm  
LED integr., 1 x 5W   
1 x 400 lm, 3000 K, **A+**



400  
LUMEN



1 - 4



1 - 4

## Walk

satin nickel  
metal/plastic

### 1. G20432/13

↑ 160mm ↔ 785mm  
→ 180mm ø  
LED integr., 4 x 4W   
4 x 380 lm, 3000 K, **A+**



4 004353 239793



### 2. G20413/13

↑ 145mm ↔ 305mm  
→ 170mm ø  
LED integr., 2 x 4W   
2 x 380 lm, 3000 K, **A+**



4 004353 239779



### 3. G20433/13

↑ 145mm ↔  
→ ø 270mm  
LED integr., 3 x 5W   
3 x 380 lm, 3000 K, **A+**



4 004353 239786



### 4. G20410/13

↑ 130mm ↔  
→ 150mm ø 80mm  
LED integr., 1 x 4W   
1 x 380 lm, 3000 K, **A+**



4 004353 239762





## Comb

satin nickel/chrome  
metal/plastic

### 1. G12232/77

↑ 160mm ↔ 720mm  
→ 190mm ø  
LED integr., 4 x 4,5W   
4 x 360 lm, 3000 K, **A+**



1440  
LUMEN

### 2. G12213/77

↑ 160mm ↔ 370mm  
→ 100mm ø  
LED integr., 2 x 4,5W   
2 x 360 lm, 3000 K, **A+**



720  
LUMEN

### 3. G12234/77

↑ 120mm ↔  
→ ø 360mm  
LED integr., 3 x 4,5W   
3 x 360 lm, 3000 K, **A+**



1080  
LUMEN

### 4. G12211/77

↑ 150mm ↔  
→ 170mm ø  
LED integr., 1 x 4,5W   
1 x 360 lm, 3000 K, **A+**



360  
LUMEN





1-3



1-3

## Benko

satin nickel/chrome  
metal/acrylic

### 1. G26230/77

↑ 90mm ↔ 510mm  
→ 175mm ø  
LED integr., 3 x 5W   
3 x 400 lm, 3000 K, **A+**



4 004353 247972

### 2. G26229/77

↑ 90mm ↔ 330mm  
→ 175mm ø  
LED integr., 2 x 5W   
2 x 400 lm, 3000 K, **A+**



4 004353 247965

### 3. G26210/77

↑ 175mm ↔ 80mm  
→ 90mm ø  
LED integr., 1 x 5W   
1 x 400 lm, 3000 K, **A+**



4 004353 247958



1200  
LUMEN



800  
LUMEN



400  
LUMEN

**LED**  
incl.

incl.  

1-5

5

## Transit

satin nickel/aluminium  
aluminium/acrylic

### 1. G67495/21

‡ 70mm ↔ 300mm  
→ 300mm ø  
LED integr., 5 x 4W   
5 x 320 lm, 3000 K, **A+**  
↗ 98375/00



### 2. G67435/21

‡ 70mm ↔ 280mm  
→ 280mm ø  
LED integr., 4 x 4W   
4 x 320 lm, 3000 K, **A+**



### 3. G67430/21

‡ 70mm ↔ 410mm  
→ 100mm ø  
LED integr., 3 x 4W   
3 x 320 lm, 3000 K, **A+**



### 4. G67429/21

‡ 70mm ↔ 260mm  
→ 100mm ø  
LED integr., 2 x 4W   
2 x 320 lm, 3000 K, **A+**



### 5. G67410/21

‡ 100mm ↔ 100mm  
→ 65mm ø  
LED integr., 1 x 4W   
1 x 320 lm, 3000 K, **A+**



SEE OTHER VERSION  
ON PAGE  
**286**

**LED**  
incl.  
1 - 4

incl.  
  
4

## Crossing

nickel/aluminium  
aluminium/pastic

### 1. G08530/21

↓ 100mm ↔ 410mm  
→ 70mm ∅  
LED integr., 3 x 4W   
3 x 320 lm, 3000 K, 



**960**  
LUMEN

### 2. G08535/21

↓ 280mm ↔ 280mm  
→ 70mm ∅  
LED integr., 4 x 4W   
4 x 320 lm, 3000 K, 



**1280**  
LUMEN

### 3. G08529/21

↓ 100mm ↔ 260mm  
→ 65mm ∅  
LED integr., 2 x 4W   
2 x 320 lm, 3000 K, 



**640**  
LUMEN

### 4. G08511/21

↓ 100mm ↔ 100mm  
→ 65mm ∅  
LED integr., 1 x 4W   
1 x 320 lm, 3000 K, 



**320**  
LUMEN

SEE OTHER VERSIONS  
ON PAGE  
**286, 411**



1 - 4



2, 4

## Pacome

chrome  
metal/glass

### 1. G35795/15

↑ 215mm ↔ 880mm  
→ 380mm ∅  
LED, G9, 5 x 3,5W   
5 x 320 lm, 3000 K, **A+**  
↗98271/95



4 004353 247804

### 2. G35713/15

↑ 210mm ↔ 400mm  
→ 100mm ∅  
LED, G9, 2 x 3,5W   
2 x 320 lm, 3000 K, **A+**  
↗98271/95



4 004353 247774

### 3. G35793/15

↑ 230mm ↔  
→ ∅ 370mm  
LED, G9, 3 x 3,5W   
3 x 320 lm, 3000 K, **A+**  
↗98271/95



4 004353 247781

### 4. G35710/15

↑ 180mm ↔  
→ ∅ 100mm  
LED, G9, 1 x 3,5W   
1 x 320 lm, 3000 K, **A+**  
↗98271/95



4 004353 247750



SPOTS





**LED**  
incl.



1 - 4

1 - 4

## Lea

satin nickel/chrome/white  
metal/glass

### 1. G32432/77

↑ 170mm ↔ 710mm  
→ 120mm ø  
LED, E14, 4 x 3W   
4 x 260 lm, 3000 K, **A+**  
98043/91



4 004353 185847



### 2. G32429/77

↑ 140mm ↔ 255mm  
→ 70mm ø  
LED, E14, 2 x 3W   
2 x 260 lm, 3000 K, **A+**  
98043/91



4 004353 185823



### 3. G32434/77

↑ 140mm ↔ 250mm  
→ 250mm ø  
LED, E14, 3 x 3W   
3 x 260 lm, 3000 K, **A+**  
98043/91



4 004353 185830



### 4. G32410/77

↑ 110mm ↔ 110mm  
→ 140mm ø  
LED, E14, 1 x 3W   
1 x 260 lm, 3000 K, **A+**  
98043/91



4 004353 185816



SEE OTHER VERSIONS  
ON PAGE  
**165**



1-5



1-5



4



5

## Giorgia

satin nickel/chrome/white metal/glass

### 1. G05532/77

↑ 170mm ↔ 930mm  
→ 65mm ø  
LED, E14, 4 x 3W   
4 x 260 lm, 3000 K, **A+**  
↗98024/98



4 004353 174100

### 2. G05529/77

↑ 170mm ↔ 400mm  
→ 65mm ø  
LED, E14, 2 x 3W   
2 x 260 lm, 3000 K, **A+**  
↗98024/98



4 004353 174094

### 3. G05535/77

↑ 170mm ↔ 370mm  
→ 370mm ø  
LED, E14, 4 x 3W   
4 x 260 lm, 3000 K, **A+**  
↗98024/98



4 004353 174117

### 4. G05511/77

↑ 170mm ↔ 90mm  
→ 150mm ø  
LED, E14, 1 x 3W   
1 x 260 lm, 3000 K, **A+**  
↗98024/98



4 004353 174087

### 5. G05505/77

↑ 475mm ↔ 60mm  
→ ø  
LED, E14, 1 x 3W   
1 x 260 lm, 3000 K, **A+**  
↗98025/98



4 004353 174339



1040 LUMEN



520 LUMEN



1040 LUMEN



260 LUMEN



260 LUMEN

SEE OTHER VERSION  
ON PAGE  
**291**





1-5



1-5



4

## Janna

satin nickel/chrome/white metal/glass

### 1. G46132/77

↑ 140mm ↔ 840mm  
→ 180mm ø  
LED, E14, 4 x 3W   
4 x 260 lm, 3000 K, **A+**  
↗92286/91



4 004353 185793



1040 LUMEN

### 2. G46116/77

↑ 140mm ↔ 550mm  
→ 180mm ø  
LED, E14, 3 x 3W   
3 x 260 lm, 3000 K, **A+**  
↗92286/91



4 004353 185786



780 LUMEN

### 3. G46113/77

↑ 140mm ↔ 380mm  
→ 180mm ø  
LED, E14, 2 x 3W   
2 x 260 lm, 3000 K, **A+**  
↗92286/91



4 004353 185779



520 LUMEN

### 4. G46112/77

↑ 120mm ↔  
→ 165mm ø 80mm  
LED, E14, 1 x 3W   
1 x 260 lm, 3000 K, **A+**  
↗92286/91



4 004353 198489



260 LUMEN

### 5. G46110/77

↑ 120mm ↔  
→ 165mm ø 80mm  
LED, E14, 1 x 3W   
1 x 260 lm, 3000 K, **A+**  
↗92286/91



4 004353 185762



260 LUMEN



1 - 4



1 - 4

## Bethany

satin nickel/chrome/white alabaster  
metal/glass

### 1. G55232/77

↑ 90mm ↔ 800mm  
→ 215mm ø  
LED, E14, 4 x 3W   
4 x 250 lm, 3000 K, **A+**  
↗92196/94



4 004353 200366



1000  
LUMEN

### 2. G55213/77

↑ 90mm ↔ 320mm  
→ 215mm ø  
LED, E14, 2 x 3W   
2 x 250 lm, 3000 K, **A+**  
↗92196/94



4 004353 200342



500  
LUMEN

### 3. G55234/77

↑ ↔  
→ 200mm ø 190mm  
LED, E14, 3 x 3W   
3 x 250 lm, 3000 K, **A+**  
↗92196/94



4 004353 200359



750  
LUMEN

### 4. G55210/77

↑ ↔  
→ 190mm ø 80mm  
LED, E14, 1 x 3W   
1 x 250 lm, 3000 K, **A+**  
↗92196/94



4 004353 200335



250  
LUMEN

**LED**  
incl.



1-5

1,3-5

## Philo

satin nickel/white  
metal/glass

### 1. G16332/13

↑ → 700mm  
→ 200mm ø  
LED, E14, 4 x 3W   
4 x 250 lm, 3000 K, **A+**



### 2. G16394/13

↑ 170mm → 680mm  
→ 400mm ø  
LED, E14, 4 x 3W   
4 x 250 lm, 3000 K, **A+**



### 3. G16313/13

↑ → 385mm  
→ 160mm ø  
LED, E14, 2 x 3W   
2 x 250 lm, 3000 K, **A+**



### 4. G16334/13

↑ → →  
→ 160mm ø 220mm  
LED, E14, 3 x 3W   
3 x 250 lm, 3000 K, **A+**



### 5. G16310/13

↑ → →  
→ 160mm ø 110mm  
LED, E14, 1 x 3W   
1 x 250 lm, 3000 K, **A+**



SEE OTHER VERSIONS  
ON PAGE  
**166 - 167**

SPOTS



**LED**  
incl.



1 - 4

1 - 4

## Magnito LED

chrome  
metal

### 1. G21631/15

‡ 80mm ↔1100mm  
→115mm ø  
LED, GU10, 4 x 3W   
4 x 250 lm, 3000 K, **A++**



4 004353 242144

1

1000  
LUMEN



### 2. G21629/15

‡ 80mm ↔450mm  
→115mm ø  
LED, GU10, 2 x 3W   
2 x 250 lm, 3000 K, **A++**



4 004353 242137

2

500  
LUMEN



### 3. G21635/15

‡ 250mm ↔250mm  
→115mm ø  
LED, GU10, 4 x 3W   
4 x 250 lm, 3000 K, **A++**



4 004353 242151

3

1000  
LUMEN



### 4. G21610/15

‡ ↔  
→115mm ø 100mm  
LED, GU10, 1 x 3W   
1 x 250 lm, 3000 K, **A++**



4 004353 242120

4

250  
LUMEN





1-4



1-4

## Milano LED

chrome/black pearl metal

### 1. G21732/76

↑ 130mm ↔ 710mm  
→ 170mm ∅  
LED, GU10, 4 x 3W   
4 x 250 lm, 3000 K, **A++**



4 004353 242182



1000  
LUMEN

### 2. G21713/76

↑ 125mm ↔ 330mm  
→ 130mm ∅  
LED, GU10, 2 x 3W   
2 x 250 lm, 3000 K, **A++**



4 004353 242175



500  
LUMEN

### 3. G21734/76

↑ ↔  
→ 130mm ∅ 330mm  
LED, GU10, 3 x 3W   
3 x 250 lm, 3000 K, **A++**



4 004353 242199



750  
LUMEN

SEE OTHER COLOURS  
ON PAGE  
**72-73**

### 4. G21710/76

↑ 120mm ↔  
→ 145mm ∅ 80mm  
LED, GU10 1 x 3W   
1 x 250 lm, 3000 K, **A++**



4 004353 242168



250  
LUMEN

**LED**  
incl.



1-3

1-3

## Movie LED

chrome  
metal

### 1. G08931/15

↑ 165mm ↔ 840mm  
→ 190mm ø

LED, GU10, 4 x 5W   
4 x 345 lm, 2700 K,



4 004353 169151



### 2. G08913/15

↑ 165mm ↔ 390mm  
→ 190mm ø

LED, GU10, 2 x 5W   
2 x 345 lm, 2700 K,



4 004353 169144



### 3. G08910/15

↑ 150mm ↔  
→ 170mm ø 140mm

LED, GU10, 1 x 5W   
1 x 345 lm, 2700 K,



4 004353 169137



SEE OTHER VERSIONS  
ON PAGE  
**91**





## Kimber LED

chrome  
metal/glass

### 1. G39230/15

↑ 120mm ↔ 680mm  
→ 150mm ø  
LED, GU10, 3 x 2,5W   
3 x 250 lm, 3000 K, **A++**



### 2. G39234/15

↑ 120mm ↔  
→ ø 340mm  
LED, GU10, 3 x 2,5W   
3 x 250 lm, 3000 K, **A++**



### 3. G39210/15

↑ 120mm ↔  
→ 150mm ø 80mm  
LED, GU10, 1 x 2,5W   
1 x 250 lm, 3000 K, **A++**



**LED**  
incl.



1 - 4

1 - 4

## Jupp LED

chrome/black pearl metal

### 1. G18332/76

↑ 135mm ↔ 765mm  
→ 165mm ∅  
LED, GU10, 4 x 3W   
4 x 250 lm, 3000 K, **A++**



4 004353 209055



1000  
LUMEN

### 2. G18313/76

↑ 135mm ↔ 315mm  
→ 165mm ∅  
LED, GU10, 2 x 3W   
2 x 250 lm, 3000 K, **A++**



4 004353 209031



500  
LUMEN

### 3. G18334/76

↑ 110mm ↔  
→ ∅ 190mm  
LED, GU10, 3 x 3W   
3 x 250 lm, 3000 K, **A++**



4 004353 209048



750  
LUMEN

### 4. G18310/76

↑ 110mm ↔  
→ 140mm ∅ 80mm  
LED, GU10, 1 x 3W   
1 x 250 lm, 3000 K, **A++**



4 004353 209024



250  
LUMEN



1 - 4



1 - 4

## Sanny

satin nickel/chrome metal

### 1. G15432/77

‡ 135mm ↔ 765mm  
→ 165mm ø  
LED, GU10, 4 x 3W   
4 x 250 lm, 3000 K, **A++**



4 004353 169854

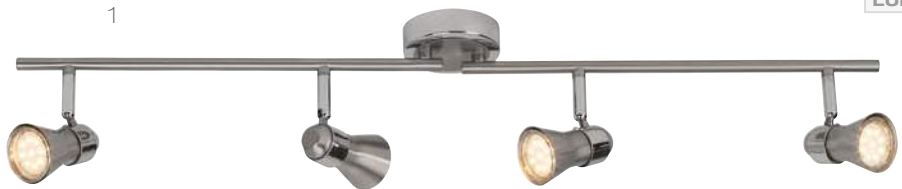

1000  
LUMEN

### 2. G15413/77

‡ 135mm ↔ 315mm  
→ 165mm ø  
LED, GU10, 2 x 3W   
2 x 250 lm, 3000 K, **A++**



4 004353 169847



500  
LUMEN

### 3. G15434/77

‡ 110mm ↔  
→ ø 190mm  
LED, GU10, 3 x 3W   
3 x 250 lm, 3000 K, **A++**



4 004353 169861



750  
LUMEN

### 4. G15410/77

‡ 110mm ↔  
→ 140mm ø 80mm  
LED, GU10, 1 x 3W   
1 x 250 lm, 3000 K, **A++**



4 004353 169830



250  
LUMEN

**LED**  
incl.



1-5

1-5

## Wesley

satin nickel/chrome  
metal

### 1. G54832/77

↑ 135mm ↔ 705mm  
→ 135mm ø  
LED, GU10, 4 x 2,5W   
4 x 220 lm, 3000 K, **A+**



4 004353 200328



880  
LUMEN

### 2. G54816/77

↑ 135mm ↔ 500mm  
→ 135mm ø  
LED, GU10, 3 x 2,5W   
3 x 220 lm, 3000 K, **A+**



4 004353 253645



660  
LUMEN

### 3. G54813/77

↑ 135mm ↔ 320mm  
→ 160mm ø  
LED, GU10, 2 x 2,5W   
2 x 220 lm, 3000 K, **A+**



4 004353 200304



440  
LUMEN

### 4. G54834/77

↑ 135mm ↔  
→ ø 190mm  
LED, GU10, 3 x 2,5W   
3 x 220 lm, 3000 K, **A+**



4 004353 200311



660  
LUMEN

### 5. G54810/77

↑ 105mm ↔  
→ 135mm ø 80mm  
LED, GU10, 1 x 2,5W   
1 x 220 lm, 3000 K, **A+**



4 004353 200298



220  
LUMEN



1-3



1-3

## Kassandra

satin nickel/chrome  
metal

1000  
LUMEN

### 1. G34735/77

‡ 110mm ↔ 290mm  
→ 290mm ø

LED, GU10, 4 x 3W   
4 x 250 lm, 3000 K, **A++**



4 004353 198175



### 2. G34729/77

‡ 110mm ↔ 305mm  
→ 70mm ø

LED, GU10, 2 x 3W   
2 x 250 lm, 3000 K, **A++**



4 004353 198168



500  
LUMEN

### 3. G34710/77

‡ 115mm ↔ 100mm  
→ 110mm ø

LED, GU10, 1 x 3W   
1 x 250 lm, 3000 K, **A++**



4 004353 198151



250  
LUMEN

**LED**  
incl.

1 - 4

## Window

satin nickel  
metal/acrylic

### 1. G19094/13

‡ 90mm ↔ 800mm  
→ 80mm ø  
LED, GU10, 4 x 3W   
4 x 250 lm, 3000 K, **A++**



**1000**  
LUMEN

### 2. G19093/13

‡ 90mm ↔ 600mm  
→ 80mm ø  
LED, GU10, 3 x 3W   
3 x 250 lm, 3000 K, **A++**



**750**  
LUMEN

### 3. G19092/13

‡ 90mm ↔ 400mm  
→ 80mm ø  
LED, GU10, 2 x 3W   
2 x 250 lm, 3000 K, **A++**



**500**  
LUMEN

### 4. G19091/13

‡ 100mm ↔ 100mm  
→ 90mm ø  
LED, GU10, 1 x 3W   
1 x 250 lm, 3000 K, **A++**



**250**  
LUMEN



**LED**  
incl.

1-2

## Window

satin nickel  
metal/acrylic

### 1. G19035/13

‡ 90mm ↔ 400mm  
→ 400mm ø  
LED, GU10, 4 x 3W   
4 x 250 lm, 3000 K, **A++**



4 004353 239137

### 2. G19095/13

‡ 90mm ↔ 500mm  
→ 500mm ø  
LED, GU10, 5 x 3W   
5 x 250 lm, 3000 K, **A++**



4 004353 239083

1



**1000  
LUMEN**

2



**1250  
LUMEN**





**LED**  
incl.



1 - 4

1 - 4

## Frame

satin nickel  
metal/acrylic

### 1. G37431/77

‡ 145mm ↔ 820mm  
→ 160mm ø  
LED, GU10, 4 x 4W   
4 x 350 lm, 3000 K, **A+**



4 004353 252242



### 2. G37430/77

‡ 145mm ↔ 640mm  
→ 160mm ø  
LED, GU10, 3 x 4W   
3 x 350 lm, 3000 K, **A+**



4 004353 252235



### 3. G37429/77

‡ 145mm ↔ 430mm  
→ 160mm ø  
LED, GU10, 2 x 4W   
2 x 350 lm, 3000 K, **A+**



4 004353 252228



### 4. G37410/77

‡ 130mm ↔ 100mm  
→ 145mm ø  
LED, GU10, 1 x 4W   
1 x 350 lm, 3000 K, **A+**



4 004353 252211





1-5



1-5



5

## Sedna

satin nickel  
metal/acrylic

### 1. G36231/77

↑ 185mm ↔ 850mm  
→ 155mm ø  
LED, GU10, 4 x 4W   
4 x 350 lm, 3000 K,



4 004353 252204

### 2. G36230/77

↑ 185mm ↔ 600mm  
→ 155mm ø  
LED, GU10, 3 x 4W   
3 x 350 lm, 3000 K,



4 004353 252198

### 3. G36229/77

↑ 185mm ↔ 350mm  
→ 155mm ø  
LED, GU10, 2 x 4W   
2 x 350 lm, 3000 K,



4 004353 252181

### 4. G36210/77

↑ 120mm ↔ 80mm  
→ 142mm ø  
LED, GU10, 1 x 4W   
1 x 350 lm, 3000 K,



4 004353 252174

### 5. G36201/77

↑ 80mm ↔ 80mm  
→ 150mm ø  
LED, GU10, 1 x 4W   
1 x 350 lm, 3000 K,



4 004353 252167



1400  
LUMEN



1050  
LUMEN

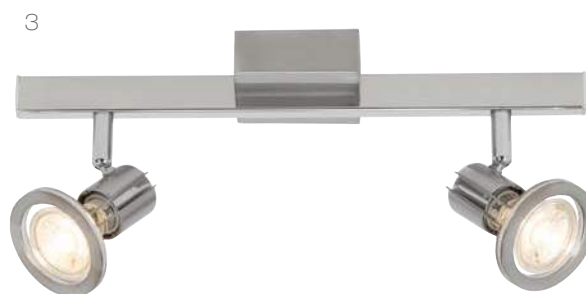

700  
LUMEN



350  
LUMEN



350  
LUMEN

**LED**  
incl.



1-3

1-3

## Ryan

satin nickel/chrome  
metal

### 1. G57432/77

‡ 130mm ↔ 780mm  
→ 175mm ø

LED, GU10, 4 x 5W   
4 x 380 lm, 3000 K, **A+**



4 004353 201264



### 2. G57413/77

‡ 120mm ↔ 275mm  
→ 160mm ø

LED, GU10, 2 x 5W   
2 x 380 lm, 3000 K, **A+**



4 004353 201257



### 3. G57410/77

‡ 110mm ↔  
→ 150mm ø 80mm

LED, GU10, 1 x 5W   
1 x 380 lm, 3000 K, **A+**



4 004353 201240



**LED**  
incl.



1 - 4

1 - 4

## Amalfi LED

satin nickel  
metal

### 1. G21532/13

↑ ↔ 600mm  
→ 130mm ∅  
LED, GU10, 4 x 3W   
4 x 250 lm, 3000 K, **A++**



### 2. G21513/13

↑ 130mm ↔ 225mm  
→ ∅  
LED, GU10, 2 x 3W   
2 x 250 lm, 3000 K, **A++**



### 3. G21534/13

↑ 110mm ↔  
→ ∅ 190mm  
LED, GU10, 3 x 3W   
3 x 250 lm, 3000 K, **A++**



### 4. G21510/13

↑ 105mm ↔  
→ 55mm ∅ 80mm  
LED, GU10, 1 x 3W   
1 x 250 lm, 3000 K, **A++**





1 - 4



1 - 4

## Loona

satin nickel  
metal

### 1. G28832/13

↑ 95mm ↔ 700mm  
→ 120mm ø  
LED, GU10, 4 x 3W   
4 x 250 lm, 3000 K, **A++**



4 004353 169892



### 2. G28813/13

↑ 95mm ↔ 225mm  
→ 120mm ø  
LED, GU10, 2 x 3W   
2 x 250 lm, 3000 K, **A++**



4 004353 169885



### 3. G28834/13

↑ ↔  
→ 140mm ø 180mm  
LED, GU10, 3 x 3W   
3 x 250 lm, 3000 K, **A++**



4 004353 169908



### 4. G28810/13

↑ ↔  
→ 140mm ø 80mm  
LED, GU10, 1 x 3W   
1 x 250 lm, 3000 K, **A++**



4 004353 169878





1-3



1-3



3

## Loona

satin nickel  
metal

### 1. G28840/13

‡ 90mm ↔ 750mm  
→ 120mm ø  
LED, GU10, 4 x 3W   
4 x 250 lm, 3000 K, **A++**



4 004353 253379



1000  
LUMEN

### 2. G28833/13

‡ 95mm ↔  
→ ø 240mm  
LED, GU10, 3 x 3W   
3 x 250 lm, 3000 K, **A++**



4 004353 253362



750  
LUMEN

### 3. G28842/13

‡ 370mm ↔ 80mm  
→ 160mm ø  
LED, GU10, 1 x 3W   
1 x 250 lm, 3000 K, **A++**



4 004353 169915



250  
LUMEN



1 - 4



1 - 4

## Loona

white  
metal

### 1. G28832/05

‡ 95mm ↔ 700mm  
→ 120mm ø  
LED, GU10, 4 x 3W   
4 x 250 lm, 3000 K, **A++**



4 004353 253355



1000  
LUMEN

### 2. G28813/05

‡ 95mm ↔ 225mm  
→ 120mm ø  
LED, GU10, 2 x 3W   
2 x 250 lm, 3000 K, **A++**



4 004353 253331



500  
LUMEN

### 3. G28834/05

‡ 75mm ↔  
→ ø 180mm  
LED, GU10, 3 x 3W   
3 x 250 lm, 3000 K, **A++**



4 004353 253348



750  
LUMEN

### 4. G28810/05

‡ ↔  
→ 140mm ø 80mm  
LED, GU10, 1 x 3W   
1 x 250 lm, 3000 K, **A++**



4 004353 253324



250  
LUMEN





1-4



1-4



4

## Lipari LED

satin nickel/white  
metal/glass

### 1. G38832/13

↑ 145mm ↔ 840mm  
→ 190mm ø  
LED, GU10, 4 x 3W   
4 x 250 lm, 3000 K, **A++**  
92204/98



4 004353 253416



1000  
LUMEN

### 2. G38816/13

↑ 145mm ↔ 600mm  
→ 190mm ø  
LED, GU10, 3 x 3W   
3 x 250 lm, 3000 K, **A++**  
92204/98



4 004353 253409



750  
LUMEN

### 3. G38813/13

↑ 145mm ↔ 400mm  
→ 190mm ø  
LED, GU10, 2 x 3W   
2 x 250 lm, 3000 K, **A++**  
92204/98



4 004353 253393



500  
LUMEN

### 4. G38811/13

↑ 125mm ↔ 120mm  
→ 175mm ø  
LED, GU10, 1 x 3W   
1 x 250 lm, 3000 K, **A++**  
92204/98



4 004353 253386



250  
LUMEN



1 - 4



1 - 4

## Ina LED

black/chrome  
metal

### 1. G77732/06

↑ 125mm ↔ 710mm  
→ 180mm ø  
LED, GU10, 4 x 3W   
4 x 250 lm, 3000 K, **A++**



4 004353 253522



1000  
LUMEN

### 2. G77729/06

↑ 147mm ↔ 255mm  
→ 180mm ø  
LED, GU10, 2 x 3W   
2 x 250 lm, 3000 K, **A++**



4 004353 253485



500  
LUMEN

### 3. G77734/06

↑ 147mm ↔  
→ ø 190mm  
LED, GU10, 3 x 3W   
3 x 250 lm, 3000 K, **A++**



4 004353 253492



750  
LUMEN

### 4. G77710/06

↑ 147mm ↔  
→ 180mm ø 80mm  
LED, GU10, 1 x 3W   
1 x 250 lm, 3000 K, **A++**



4 004353 253478



250  
LUMEN

SEE OTHER VERSIONS  
ON PAGE  
**90, 350**

**LED**  
incl.



1 - 4

1 - 4

## Ina LED

white/chrome  
metal

### 1. G77732/05

↑ 125mm ↔ 710mm  
→ 180mm ø  
LED, GU10, 4 x 3W   
4 x 250 lm, 3000 K, **A++**



4 004353 232718



### 2. G77729/05

↑ 147mm ↔ 255mm  
→ 180mm ø  
LED, GU10, 2 x 3W   
2 x 250 lm, 3000 K, **A++**



4 004353 232695



### 3. G77734/05

↑ 147mm ↔  
→ ø 190mm  
LED, GU10, 3 x 3W   
3 x 250 lm, 3000 K, **A++**



4 004353 232701



### 4. G77710/05

↑ 147mm ↔  
→ 180mm ø 80mm  
LED, GU10, 1 x 3W   
1 x 250 lm, 3000 K, **A++**



4 004353 232688



**LED**  
incl.



1-3

1-3

## Cinda LED

cream shiny/chrome  
metal

### 1. G10929/75

↑ 160mm ↔ 300mm  
→ 120mm ø  
LED, GU10, 2 x 3W   
2 x 250 lm, 3000 K, **A++**



4 004353 169175

### 2. G10934/75

↑ 160mm ↔  
→ ø 210mm  
LED, GU10, 3 x 3W   
3 x 250 lm, 3000 K, **A++**



4 004353 169199

### 3. G10910/75

↑ ↔  
→ 160mm ø 80mm  
LED, GU10, 1 x 3W   
1 x 250 lm, 3000 K, **A++**



4 004353 169168

1



**500**  
LUMEN

2



**750**  
LUMEN

3



**250**  
LUMEN

**LED**  
incl.



1-3

1-3

## Movie LED

black matt  
metal

### 1. G08931/76

↑ 165mm ↔ 840mm  
→ 190mm ø  
LED, GU10, 4 x 5W   
4 x 345 lm, 2700 K, **A+**



4 004353 241710



**1380**  
LUMEN

### 2. G08913/76

↑ 165mm ↔ 390mm  
→ 190mm ø  
LED, GU10, 2 x 5W   
2 x 345 lm, 2700 K, **A+**



4 004353 241703



**690**  
LUMEN

### 3. G08910/76

↑ 150mm ↔  
→ 170mm ø 140mm  
LED, GU10, 1 x 5W   
1 x 345 lm, 2700 K, **A+**



4 004353 241697



**345**  
LUMEN

SEE OTHER COLOUR  
ON PAGE  
**52**

SEE OTHER VERSION  
ON PAGE  
**526**



1 - 4



1 - 4

## Milano LED

chrome/white metal

### 1. G21732/75

‡ 130mm ↔710mm  
→170mm ø  
LED, GU10, 4 x 3W   
4 x 250 lm, 3000 K, **A++**



4 004353 254192



1000 LUMEN

### 2. G21713/75

‡ 110mm ↔275mm  
→155mm ø  
LED, GU10, 2 x 3W   
2 x 250 lm, 3000 K, **A++**



4 004353 254154



500 LUMEN

### 3. G21734/75

‡                      ↔  
→130mm ø 330mm  
LED, GU10, 3 x 3W   
3 x 250 lm, 3000 K, **A++**



4 004353 254178



750 LUMEN

### 4. G21710/75

‡ 120mm ↔  
→145mm ø 80mm  
LED, GU10, 1 x 3W   
1 x 250 lm, 3000 K, **A++**



4 004353 254130



250 LUMEN

SEE OTHER COLOUR  
ON PAGE  
**51**

**LED**  
incl.



1-4

1-4

## Milano LED

chrome/grey  
metal

### 1. G21732/22

↑ 130mm ↔ 710mm  
→ 170mm ∅  
LED, GU10, 4 x 3W   
4 x 250 lm, 3000 K, **A++**



4 004353 254208



**1000  
LUMEN**

### 2. G21713/22

↑ 110mm ↔ 275mm  
→ 155mm ∅  
LED, GU10, 2 x 3W   
2 x 250 lm, 3000 K, **A++**



4 004353 254161

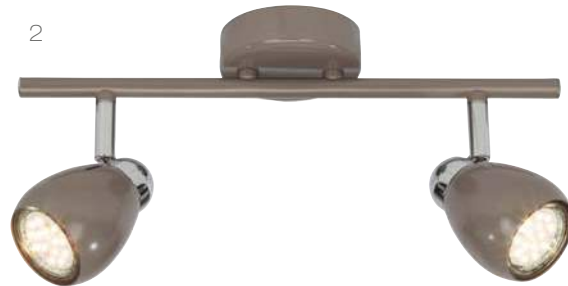

**500  
LUMEN**

### 3. G21734/22

↑ ↔  
→ 130mm ∅ 330mm  
LED, GU10, 3 x 3W   
3 x 250 lm, 3000 K, **A++**



4 004353 254185



**750  
LUMEN**

### 4. G21710/22

↑ 120mm ↔  
→ 145mm ∅ 80mm  
LED, GU10, 1 x 3W   
1 x 250 lm, 3000 K, **A++**



4 004353 254147



**250  
LUMEN**





## Bonnie

smoked glass  
metal/glass

### 1. G94209/93

- ↑ 160mm ↔
- ∅ 240mm
- LED, GU10., 3 x 5W
- 3 x 250 lm, 3000 K, **A**
- LED integr., 1 x 5W



4 004353 192791

1



750  
LUMEN



SPOTS





1-3



1-3

## Cinta

chrome/transparent  
metal/glass

### 1. G22632/15

↑ 150mm ↔ 840mm  
→ 220mm ∅  
LED, G9, 4 x 3,5W   
4 x 320 lm, 3000 K, **A+**  
↗ 98257/00



4 004353 248931



1280  
LUMEN

### 2. G22613/15

↑ 145mm ↔ 360mm  
→ 220mm ∅  
LED, G9, 2 x 3,5W   
2 x 320 lm, 3000 K, **A+**  
↗ 98257/00



4 004353 246067



640  
LUMEN

### 3. G22610/15

↑ 125mm ↔  
→ 190mm ∅ 100mm  
LED, G9, 1 x 3,5W   
1 x 320 lm, 3000 K, **A+**  
↗ 98257/00



4 004353 246050



320  
LUMEN

SEE OTHER VERSIONS  
ON PAGE  
**196**



1 - 4



1, 2, 4

## Theron

chrome  
metal/glass

### 1. 34432/15

‡ 120mm ↔ 820mm  
→ 220mm ø  
QT14, G9, 4 x 33W  
♣98074/15



4 004353 224423



### 2. 34413/15

‡ 120mm ↔ 440mm  
→ 220mm ø  
QT14, G9, 2 x 33W  
♣98074/15



4 004353 224416



### 3. 34493/15

‡ 210mm ↔  
→ 210mm ø 380mm  
QT14, G9, 3 x 33W  
♣98074/15



4 004353 224430



### 4. 34410/15

‡ 110mm ↔  
→ 170mm ø  
QT14, G9, 1 x 33W  
♣98074/15



4 004353 224409





1-3



1-3

## Bulb

chrome/transparent  
metal/glass

### 1. 21216/15

↑ 195mm ↔ 530mm  
→ 120mm ∅  
QT14, G9, 3 x 33W  
↗98253/00



### 2. 21213/15

↑ 195mm ↔ 370mm  
→ 120mm ∅  
QT14, G9, 2 x 33W  
↗98253/00



### 3. 21210/15

↑ 170mm ↔ 93mm  
→ 100mm ∅ 93mm  
QT14, G9, 1 x 33W  
↗98253/00



3



SEE OTHER VERSIONS  
ON PAGE  
**192**





1 - 4



1 - 4

## Wega

chrome/transparent  
metal/glass

### 1. 24532/15

‡ 115mm ↔ 1020mm  
→ 215mm ø  
C35, E14, 4 x 40W  
↗ 92542/15, 92560/15



4 004353 130533



### 2. 24529/15

‡ 100mm ↔ 320mm  
→ 200mm ø  
C35, E14, 2 x 40W  
↗ 92542/15, 92560/15



4 004353 130526



### 3. 24534/15

‡ 100mm ↔ 250mm  
→ 200mm ø 190mm  
C35, E14, 3 x 40W  
↗ 92542/15, 92560/15



4 004353 130540



### 4. 24510/15

‡ 100mm ↔ 142mm  
→ 200mm ø  
C35, E14, 1 x 40W  
↗ 92542/15, 92560/15



4 004353 130519



SEE OTHER VERSION  
ON PAGE  
**553**



1-3



1-3



1-3

## Kensington

chrome/white  
metal/glass

### 1. 50416/15

↓ 145mm ↔ 520mm  
→ 185mm ∅  
QT14, G9, 3 x 33W  
↗ 98367/05



4 004353 254284



1

### 2. 50434/15

↓ 165mm ↔  
→ ∅ 205mm  
QT14, G9, 3 x 33W  
↗ 98367/05



4 004353 254291



2

### 3. 50410/15

↓ 145mm ↔  
→ 185mm ∅ 90mm  
QT14, G9, 1 x 33W  
↗ 98367/05



4 004353 254277



3







1-3



1-3



1-3

## Leeds

chrome/transparent/mattglass  
metal/glass

### 1. 34831/15

↓ 130mm ↔ 745mm  
→ 0  
QT14, G9, 4 x 33W  
↗ 98373/00



### 2. 34829/15

↓ 120mm ↔ 468mm  
→ 80mm ∅  
QT14, G9, 2 x 33W  
↗ 98373/00

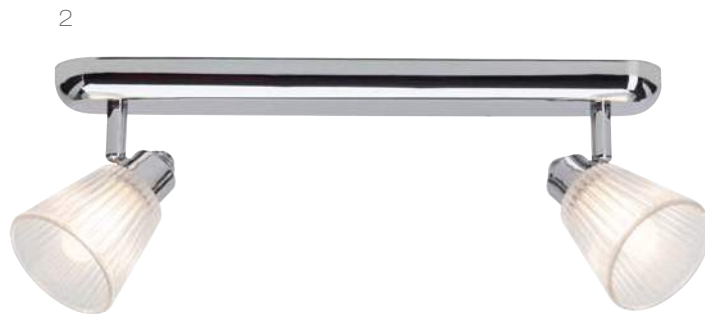

### 3. 34810/15

↓ 130mm ↔  
→ 123mm ∅ 90mm  
QT14, G9, 1 x 33W  
↗ 98373/00





1-3



1-3

## Furore

satin nickel/white  
metal/glass

### 1. 65013/77

↓ 220mm ↔ 380mm  
→ ∅  
QC35, E14, 2 x 28W  
↗ 98126/05



4 004353 205910



### 2. 65034/77

↓ 180mm ↔  
→ ∅ 235mm  
QC35, E14, 3 x 28W  
↗ 98126/05



4 004353 205927



### 3. 65010/77

↓ 180mm ↔  
→ 140mm ∅  
QC35, E14, 1 x 28W  
↗ 98126/05



4 004353 205903



**BULBS**

Seite / page  
10 - 11



SPOTS





1 - 4



1 - 4

## Bona

satin nickel/white  
metal/glass

### 1. 10532/05

‡ 160mm ↔ 940mm  
→ 190mm ø  
D45, E14, 4 x 40W  
↗92491/05



4 004353 110276



### 2. 10513/05

‡ 160mm ↔ 450mm  
→ 190mm ø  
D45, E14, 2 x 40W  
↗92491/05



4 004353 110269



### 3. 10534/05

‡ 140mm ↔ 340mm  
→ 170mm ø 190mm  
D45, E14, 3 x 40W  
↗92491/05



4 004353 110283



### 4. 10510/05

‡ 140mm ↔ 120mm  
→ 170mm ø  
D45, E14, 1 x 40W  
↗92491/05



4 004353 110252



SEE OTHER VERSIONS  
ON PAGE  
**225**



1 - 4



1 - 4

## Tiara

satin nickel/chrome/white  
metal/glass

### 1. 15632/13

↓ 160mm ↔ 780mm  
→ ∅  
D45, E14, 4 x 40W  
↗ 98001/05



4 004353 164385



### 2. 15613/13

↓ 160mm ↔ 385mm  
→ ∅  
D45, E14, 2 x 40W  
↗ 98001/05



4 004353 164361



### 3. 15634/13

↓ 150mm ↔  
→ ∅ 220mm  
D45, E14, 3 x 40W  
↗ 98001/05



4 004353 164408



### 4. 15610/13

↓ 150mm ↔  
→ ∅ 110mm  
D45, E14, 1 x 40W  
↗ 98001/05



4 004353 164347





1-3



1-4



4

## Oca

satin nickel/chrome/white  
metal/plastic/glass

### 1. 39432/77

‡ 900mm ↔ 900mm  
→ 180mm ø  
R50, E14, 4 x 40W  
D45, E14, 4 x 40W  
91885/91



4 004353 027901

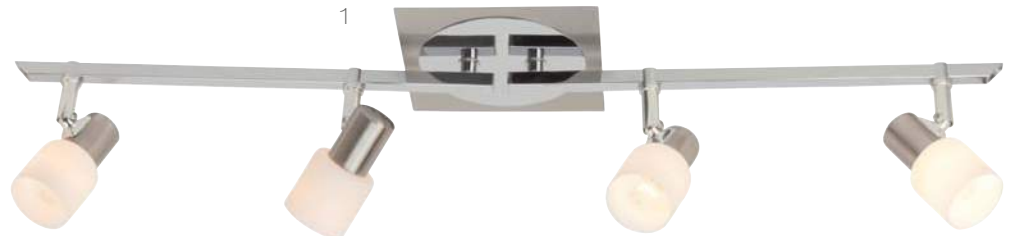

### 2. 39429/77

‡ 95mm ↔ 380mm  
→ 180mm ø  
R50, E14, 2 x 40W  
D45, E14, 2 x 40W  
91885/91



4 004353 019128



### 3. 39434/77

‡ 250mm ↔ 250mm  
→ 180mm ø  
R50, E14, 3 x 40W  
D45, E14, 3 x 40W  
91885/91



4 004353 019159



### 4. 39411/77

‡ 100mm ↔ 100mm  
→ 180mm ø  
R50, E14, 1 x 40W  
D45, E14, 1 x 40W  
91885/91



4 004353 019111





1-3,5



1-5



4

## Luca

satin nickel/chrome/white  
metal/glass

### 1. 35832/77

↑ 150mm ↔ 810mm  
→ 165mm ø  
R50, E14, 4 x 40W  
D45, E14, 4 x 40W  
↗92286/91



4 004353 036385



### 2. 35816/77

↑ 150mm ↔ 460mm  
→ 165mm ø  
R50, E14, 3 x 40W  
D45, E14, 3 x 40W  
↗92286/91



4 004353 036361



### 3. 35813/77

↑ 150mm ↔ 350mm  
→ 165mm ø  
R50, E14, 2 x 40W  
D45, E14, 2 x 40W  
↗92286/91



4 004353 036347

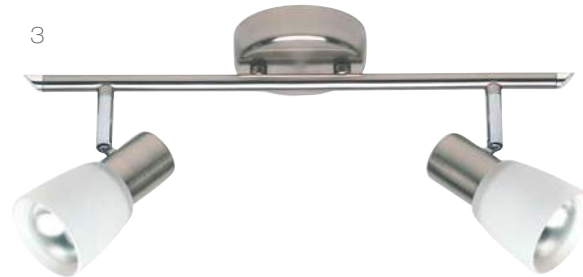

### 4. 35812/77

↑ 135mm ↔  
→ 145mm ø 85mm  
D45, E14, 1 x 18W  
↗92286/91



4 004353 045400



### 5. 35810/77

↑ 135mm ↔  
→ 145mm ø 85mm  
R50, E14, 1 x 40W  
D45, E14, 1 x 40W  
↗92286/91



4 004353 036286



SEE OTHER COLOUR  
ON PAGE  
**129**





1 - 4



1 - 4

## Sofia

satin nickel/chrome/white alabaster  
metal/glass

### 1. 55331/77

↑ 130mm ↔ 760mm  
→ 175mm ø  
D45, E14, 4 x 40W  
↗92196/94



4 004353 038587



### 2. 55316/77

↑ 100mm ↔ 570mm  
→ 215mm ø  
D45, E14, 3 x 40W  
↗92196/94



4 004353 038556



### 3. 55313/77

↑ 100mm ↔ 330mm  
→ 215mm ø  
D45, E14, 2 x 40W  
↗92196/94



4 004353 038532



### 4. 55334/77

↑ ↔  
→ 185mm ø 200mm  
D45, E14, 3 x 40W  
↗92196/94



4 004353 038594



SEE OTHER COLOUR  
ON PAGE

**130 - 133**



2



1-2

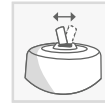

1

## Sofia

satin nickel/chrome/white alabaster  
metal/glass

### 1. 55390/77

↑ ↓ → ←  
→ 370mm ø 90mm  
D45, E14, 1 x 40W  
92196/94



4 004353 038600

### 2. 55310/77

↑ ↓ → ←  
→ 190mm ø 80mm  
D45, E14, 1 x 40W  
92196/94



4 004353 038525

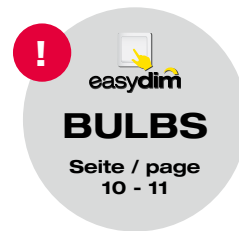



1 - 4



1 - 4

## Ina

satin nickel/chrome metal

### 1. 07732/77

‡ 160mm ↔710mm  
→95mm ø  
QPAR51, GU10, 4 x 28W



### 2. 07713/77

‡ 110mm ↔275mm  
→155mm ø  
QPAR51, GU10, 2 x 28W



### 3. 07734/77

‡ 155mm ↔  
→ ø 190mm  
QPAR51, GU10, 3 x 28W



### 4. 07710/77

‡ 110mm ↔  
→155mm ø 80mm  
QPAR51, GU10, 1 x 28W



SEE OTHER VERSIONS  
ON PAGE  
**68 - 69**



1-3



1-3

## Movie

chrome  
metal

### 1. 07831/15

‡ 155mm ↔820mm  
→135mm ø  
QPAR51, GU10, 4 x 35W



### 2. 07813/15

‡ 155mm ↔365mm  
→135mm ø  
QPAR51, GU10, 2 x 35W



### 3. 07810/15

‡ 135mm ↔90mm  
→155mm ø  
QPAR51, GU10, 1 x 35W



SEE OTHER VERSIONS  
ON PAGE  
**52**



! easydim  
**BULBS**  
Seite / page  
10 - 11



1 - 4



1 - 2, 4

## Charlie

chrome  
metal

### 1. 18196/15

↑ 150mm ↔ 660mm  
→ 200mm ø  
QT14, G9, 6 x 33W



4



### 2. 18113/15

↑ 120mm ↔ 310mm  
→ 160mm ø  
QT14, G9, 2 x 33W



4



### 3. 18193/15

↑ 200mm ↔  
→ ø 380mm  
QT14, G9, 3 x 33W



4



### 4. 18110/15

↑ 120mm ↔  
→ 160mm ø 80mm  
QT14, G9, 1 x 33W



4





1 - 4



1 - 4

## Virgo

chrome  
metal

### 1. G02231/15

↑ 140mm ↔ 585mm  
→ 170mm ø  
QT14, G9, 4 x 33W   
4 x 458 lm, 2800 K  
↗ 98012/15



4 004353 173783

### 2. G02213/15

↑ 140mm ↔ 300mm  
→ 170mm ø  
QT14, G9, 2 x 33W   
2 x 458 lm, 2800 K  
↗ 98012/15



4 004353 173769

### 3. G02233/15

↑ 140mm ↔  
→ ø 250mm  
QT14, G9, 3 x 33W   
3 x 458 lm, 2800 K  
↗ 98012/15



4 004353 173806

### 4. G02210/15

↑ 130mm ↔  
→ 160mm ø  
QT14, G9, 1 x 33W   
1 x 458 lm, 2800 K  
↗ 98012/15



4 004353 173745



1



2



3



4

SEE OTHER VERSIONS  
ON PAGE  
**204 - 205**

SEE OTHER COLOUR  
ON PAGE  
**126**



1 - 4



1 - 4

## Lava

satin nickel/chrome metal

### 1. 39532/77

‡ 110mm ↔ 710mm  
→ 175mm ø  
R50, E14, 4 x 40W  
D45, E14, 4 x 28W



4 004353 036590



### 2. 39516/77

‡ 110mm ↔ 500mm  
→ 175mm ø  
R50, E14, 2 x 40W  
D45, E14, 2 x 28W



4 004353 036576



### 3. 39513/77

‡ 110mm ↔ 370mm  
→ 175mm ø  
R50, E14, 2 x 40W  
D45, E14, 2 x 28W



4 004353 036552



### 4. 39510/77

‡ 110mm ↔  
→ 175mm ø 80mm  
R50, E14, 1 x 40W  
D45, E14, 1 x 28W



4 004353 036538



SEE OTHER COLOUR  
ON PAGE  
124



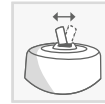

## Stella

satin nickel/chrome  
metal

1.38090/77 

↑ 105mm ↔  
→285mm ø 150mm  
R50, E14, 1 x 40W

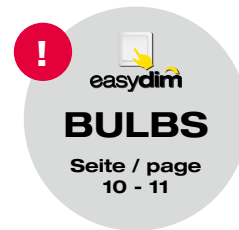



1-3



1-3

## Rider

black shiny/chrome  
metal/glass

### 1. G14932/06

‡ 220mm ↔ 830mm  
→ 140mm ø  
QT14, G9, 4 x 33W   
4 x 458 lm, 2800 K  
↗ 92595/00



### 2. G14913/06

‡ 220mm ↔ 370mm  
→ 140mm ø  
QT14, G9, 2 x 33W   
2 x 458 lm, 2800 K  
↗ 92595/00



### 3. G14910/06

‡ 190mm ↔ 120mm  
→ 220mm ø  
QT14, G9, 1 x 33W   
1 x 458 lm, 2800 K  
↗ 92595/00



SEE OTHER VERSIONS  
ON PAGE  
**257**

SEE OTHER COLOUR  
ON PAGE  
**114**

SPOTS





1-3



1-3

## Kora

white/chrome  
metal

### 1. 37934/75

‡ 100mm ↔  
→110mm ø 200mm  
QPAR51, GU10, 3 x 40W



4 004353 224621

### 2. 37924/75

‡ 115mm ↔250mm  
→130mm ø  
QPAR51, GU10, 2 x 40W



4 004353 224591

### 3. 37910/75

‡ 115mm ↔  
→130mm ø 125mm  
QPAR51, GU10, 1 x 40W



4 004353 224539

1



2



3





1-3



1-3

## Kora

black/chrome  
metal

### 1. 37934/76

‡ 100mm ↔  
→110mm ø 200mm  
QPAR51, GU10, 3 x 40W



4 004353 224652

### 2. 37924/76

‡ 115mm ↔250mm  
→130mm ø  
QPAR51, GU10, 2 x 40W



4 004353 224645

### 3. 37910/76

‡ 115mm ↔  
→130mm ø 125mm  
QPAR51, GU10, 1 x 40W



4 004353 224638

1



2



3





1-3



1-3

## Kora

grey shiny/chrome  
metal

### 1. 37934/52

‡ 100mm ↔  
→110mm ø 200mm  
QPAR51, GU10, 3 x 40W



4 004353 224614

### 2. 37924/52

‡ 115mm ↔250mm  
→130mm ø  
QPAR51, GU10, 2 x 40W



4 004353 224584

### 3. 37910/52

‡ 115mm ↔  
→130mm ø 125mm  
QPAR51, GU10, 1 x 40W



4 004353 224515



1

2



3

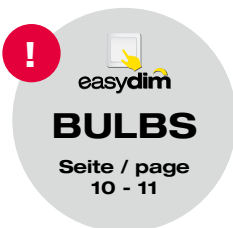



1-3



1-3

## Kora

red/chrome  
metal

### 1. 37934/71

‡ 100mm ↔  
→110mm ø 200mm  
QPAR51, GU10, 3 x 40W



4 004353 224607

### 2. 37924/71

‡ 115mm ↔250mm  
→130mm ø  
QPAR51, GU10, 2 x 40W



4 004353 224560

### 3. 37910/71

‡ 115mm ↔  
→130mm ø 125mm  
QPAR51, GU10, 1 x 40W



4 004353 224508

1



2



3







1-3



1-3

## White Ball

white  
metal

### 1. 35631/05

‡ 155mm ↔ 690mm  
→ 120mm ø  
QPAR51, GU10, 4 x 28W



1



### 2. 35634/05

‡ 155mm ↔  
→ ø 290mm  
QPAR51, GU10, 3 x 28W



2



### 3. 35610/05

‡ 155mm ↔  
→ ø 120mm  
QPAR51, GU10, 1 x 28W



3



SPOTS





1-3



1-3

## Different

white  
metal

### 1. 27030/05

‡ 132mm ↔ 332mm  
→ 125mm ø  
QPAR51, GU10, 3 x 35W



### 2. 27035/05

‡ 133mm ↔ 197mm  
→ 197mm ø  
QPAR51, GU10, 4 x 35W



### 3. 27010/05

‡ 132mm ↔  
→ 125mm ø 70mm  
QPAR51, GU10, 1 x 35W





1-2



2

## Different

white  
metal

### 1. 27091/05

‡ 97mm ↔  
→ ø 55mm  
QPAR51, GU10, 1 x 35W



1



### 2. 94416/05

‡ 145mm ↔ 1190mm  
→ 93mm ø  
QPAR51, GU10, 6 x 35W



2





1-3



1-3

## Aztekas

white/silver  
metal

### 1. 24932/75

‡ 180mm ↔ 900mm  
→ 110mm ø  
D45, E14, 4 x 28W



### 2. 24913/75

‡ 180mm ↔ 430mm  
→ 110mm ø  
D45, E14, 2 x 28W



### 3. 24910/75

‡ 155mm ↔ 135mm  
→ 110mm ø  
D45, E14, 1 x 28W



SEE OTHER VERSIONS  
ON PAGE  
**215**





1-3



1-3

## Aztekas

white/gold  
metal

### 1. 24932/85

‡ 180mm ↔ 900mm  
→ 110mm ø  
D45, E14, 4 x 28W



4 004353 247835



### 2. 24913/85

‡ 180mm ↔ 430mm  
→ 110mm ø  
D45, E14, 2 x 28W



4 004353 247811



### 3. 24910/85

‡ 155mm ↔ 135mm  
→ 110mm ø  
D45, E14, 1 x 28W



4 004353 247743





1-3



1-3

## Sandra

chrome/white  
metal/textile

### 1. G85031/05

‡ 270mm ↔ 770mm  
→ 190mm ø  
QT14, G9, 4 x 40W



4 004353 169755

### 2. G85029/05

‡ 345mm ↔ 270mm  
→ 190mm ø  
QT14, G9, 2 x 40W



4 004353 169731

### 3. G85091/05

‡ 185mm ↔  
→ ø 135mm  
QT14, G9, 1 x 40W



4 004353 169779



SEE OTHER VERSIONS  
ON PAGE  
**441**





1-3



1-3

## Sandra

black matt  
metal/textile

### 1. G85031/06

↑ 270mm ↔ 770mm  
→ 190mm ø  
QT14, G9, 4 x 40W



1



### 2. G85029/06

↑ 345mm ↔ 270mm  
→ 190mm ø  
QT14, G9, 2 x 40W



2



### 3. G85091/06

↑ 185mm ↔  
→ ø 135mm  
QT14, G9, 1 x 40W



3





1-2



1-3



3

## Grafitti

anthracite  
metal

### 1. 94476/63

‡ 710mm ↔ 1660mm  
→ 1060mm ø  
QPAR51, GU10, 4 x 35W



4 004353 250590

### 2. 94475/63

‡ 365mm ↔  
→ ø 80mm  
QPAR51, GU10, 1 x 35W



4 004353 250606

### 3. 94474/63

‡ 520mm ↔ 100mm  
→ 560mm ø  
QPAR51, GU10, 1 x 35W



4 004353 250613



SPOTS





1-3



1-3

## Dalma

black/copper  
metal

### 1. 21034/76

↑ 160mm ↔  
→ ø 220mm  
QT14, G9, 3 x 33W



4 004353 240348

### 2. 21013/76

↑ 200mm ↔ 315mm  
→ 170mm ø  
QT14, G9, 2 x 33W



4 004353 240331

### 3. 21010/76

↑ 160mm ↔  
→ 135mm ø 100mm  
QT14, G9, 1 x 33W



4 004353 240324

1



2



3



SEE OTHER VERSIONS  
ON PAGE  
**242 - 243**



1-2



1-2

## Dalma

black/copper  
metal

### 1. 21094/76

‡ 200mm ↔ 400mm  
→ 250mm ø  
QT14, G9, 4 x 33W



### 2. 21096/76

‡ 200mm ↔ 710mm  
→ 420mm ø  
QT14, G9, 6 x 33W



1



2





1-3



1-3

## Rider

concrete grey  
metal/glass

### 1. 14932/70

‡ 220mm ↔ 830mm  
→ 140mm ø  
QT14, G9, 4 x 33W  
↗92595/00



4 004353 250927

1



### 2. 14913/70

‡ 220mm ↔ 370mm  
→ 140mm ø  
QT14, G9, 2 x 33W  
↗92595/00



4 004353 250897

2



### 3. 14910/70

‡ 190mm ↔ 120mm  
→ 220mm ø  
QT14, G9, 1 x 33W  
↗92595/00



4 004353 250873

3



SEE OTHER COLOUR  
ON PAGE  
**96**





**LED**  
incl.



1-3

1-3

## Bente

concrete grey  
metal

### 1. G26334/70

↑ 135mm ↔  
→ ø 215mm  
LED, GU10, 3 x 4W   
3 x 350 lm, 3000 K, **A+**



### 2. G26324/70

↑ 135mm ↔  
→ ø 165mm  
LED, GU10, 2 x 4W   
2 x 350 lm, 3000 K, **A+**



### 3. G26310/70

↑ 135mm ↔  
→ ø 85mm  
LED, GU10, 1 x 4W   
1 x 350 lm, 3000 K, **A+**



1050  
LUMEN



700  
LUMEN



350  
LUMEN



1-3

## Bentli

antique black  
metal/glass

### 1. 26834/76

↓ 195mm → 320mm  
→ 295mm ∅  
LED, GU10, 3 x 7W  
↗ 98269/00



1



### 2. 26824/76

↓ 195mm → 255mm  
→ 198mm ∅  
LED, GU10, 2 x 7W  
↗ 98269/00



2



### 3. 26810/76

↓ 195mm → 134mm  
→ 154mm ∅  
LED, GU10, 1 x 7W  
↗ 98269/00



3





## Tribe

oak/satin nickel  
wood/metal

### 1. G33735/88

‡ 200mm ↔ 310mm  
→ 310mm ø  
LED, GU10, 4 x 5,5W   
4 x 450 lm, 3000 K,



1800  
LUMEN



### 2. G33730/88

‡ 200mm ↔ 460mm  
→ 140mm ø  
LED, GU10, 3 x 5,5W   
3 x 450 lm, 3000 K,



1350  
LUMEN



### 3. G33729/88

‡ 200mm ↔ 320mm  
→ 140mm ø  
LED, GU10, 2 x 5,5W   
2 x 450 lm, 3000 K,



900  
LUMEN



### 4. G33710/88

‡ 140mm ↔ 140mm  
→ 200mm ø  
LED, GU10, 1 x 5,5W   
1 x 450 lm, 3000 K,



450  
LUMEN





SPOTS





1 - 4



1 - 4

## Forest

oak/white alabaster  
wood/glass

### 1. 23131/35

‡ 160mm ↔ 775mm  
→ 70mm ø  
D45, E14, 4 x 28W  
♣98260/94



4 004353 246517

1



### 2. 23130/35

‡ 160mm ↔ 550mm  
→ 70mm ø  
D45, E14, 3 x 28W  
♣98260/94



4 004353 246500

2



### 3. 23129/35

‡ 160mm ↔ 380mm  
→ 70mm ø  
D45, E14, 2 x 28W  
♣98260/94



4 004353 246494

3



### 4. 23110/35

‡ 180mm ↔ 70mm  
→ 165mm ø  
D45, E14, 1 x 28W  
♣98260/94



4 004353 246487

4





1 - 4



1 - 4

## Fort

birch/white  
wood/glass

### 1. 23431/50

‡ 130mm ↔ 775mm  
→ 180mm ø  
D45, E14, 4 x 30W  
♣98261/05



4 004353 246562



### 2. 23430/50

‡ 130mm ↔ 550mm  
→ 180mm ø  
D45, E14, 3 x 30W  
♣98261/05



4 004353 246555



### 3. 23429/50

‡ 130mm ↔ 400mm  
→ 180mm ø  
D45, E14, 2 x 30W  
♣98261/05



4 004353 246548



### 4. 23410/50

‡ 180mm ↔ 70mm  
→ 130mm ø  
D45, E14, 1 x 30W  
♣98261/05



4 004353 246524





1 - 4



1 - 4

## Tree

oak/white  
wood/glass

### 1. 33331/35

‡ 180mm ↔ 880mm  
→ 94mm ø  
C35, E14, 4 x 30W  
↗98320/00



4 004353 251610



### 2. 33330/35

‡ 180mm ↔ 660mm  
→ 94mm ø  
C35, E14, 3 x 30W  
↗98320/00



4 004353 251597

2



### 3. 33329/35

‡ 180mm ↔ 510mm  
→ 94mm ø  
C35, E14, 2 x 30W  
↗98320/00



4 004353 251580

3



### 4. 33310/35

‡ 190mm ↔ 94mm  
→ 180mm ø  
C35, E14, 1 x 30W  
↗98320/00



4 004353 251566

4







1 - 4



1 - 4

## Tree

birch/white  
wood/glass

### 1. 33331/50

↑ 180mm ↔ 880mm  
→ 94mm ø  
C35, E14, 4 x 30W  
↗98320/00



4 004353 251542

1

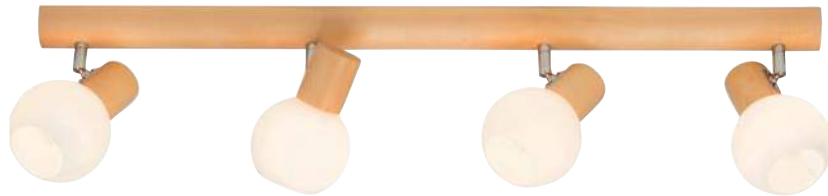

### 2. 33330/50

↑ 180mm ↔ 660mm  
→ 94mm ø  
C35, E14, 3 x 30W  
↗98320/00



4 004353 251535

2



### 3. 33329/50

↑ 180mm ↔ 510mm  
→ 94mm ø  
C35, E14, 2 x 30W  
↗98320/00



4 004353 251528

3



### 4. 33310/50

↑ 190mm ↔ 94mm  
→ 180mm ø  
C35, E14, 1 x 30W  
↗98320/00



4 004353 251511

4





1 - 4



1 - 4

## Lava

old copper metal

### 1. 39532/56

↑ 110mm ↔ 710mm  
→ 175mm ø  
R50, E14, 4 x 40W  
D45, E14, 4 x 28W



4 004353 036583



### 2. 39516/56

↑ 110mm ↔ 500mm  
→ 175mm ø  
R50, E14, 3 x 40W  
D45, E14, 3 x 28W



4 004353 036569



### 3. 39513/56

↑ 110mm ↔ 370mm  
→ 175mm ø  
R50, E14, 2 x 40W  
D45, E14, 2 x 28W



4 004353 036545



### 4. 39510/56

↑ 110mm ↔  
→ 175mm ø 80mm  
R50, E14, 1 x 40W  
D45, E14, 1 x 28W



4 004353 036521

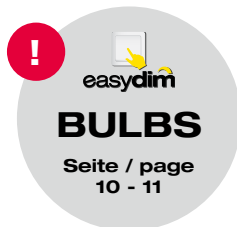

SEE OTHER COLOUR  
ON PAGE  
**94**





1 - 4



1 - 4

## Juno

beech/satin nickel  
metal/wood

### 1. 57632/70

↑ 130mm ↔ 900mm  
→ 160mm ø  
R50, E14, 4 x 40W



4 004353 027963



### 2. 57629/70

↑ 65mm ↔ 300mm  
→ 160mm ø  
R50, E14, 2 x 40W



4 004353 014543



### 3. 57634/70

↑ ↔  
→ 160mm ø 230mm  
R50, E14, 3 x 40W



4 004353 014635



### 4. 57610/70

↑ ↔  
→ 160mm ø 90mm  
R50, E14, 1 x 40W



4 004353 014512

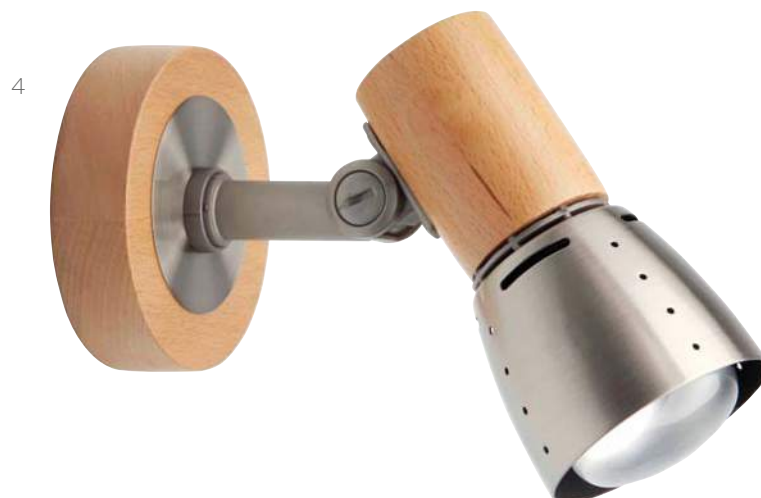



1-4



1-4

## Virgo

brown  
metal

### 1. 02231/20

↑ 140mm ↔ 585mm  
→ 170mm ∅  
QT14, G9, 4 x 33W  
↗ 98012/20



4 004353 228667



### 2. 02213/20

↑ 140mm ↔ 300mm  
→ 170mm ∅  
QT14, G9, 2 x 33W  
↗ 98012/20



4 004353 228650



### 3. 02233/20

↑ 140mm ↔  
→ ∅ 250mm  
QT14, G9, 3 x 33W  
↗ 98012/20



4 004353 228674



### 4. 02210/20

↑ 130mm ↔  
→ 160mm ∅  
QT14, G9, 1 x 33W  
↗ 98012/20



4 004353 228643



SEE OTHER COLOUR  
ON PAGE  
**93**



1-3



1-3

## Gabon

brown/white alabaster  
metal/glass

### 1. 12913/20

↑ ↔ 305mm  
→ 170mm ø  
D45, E14, 2 x 40W  
↗ 98026/94



### 2. 12934/20

↑ ↔  
→ 140mm ø 180mm  
D45, E14, 3 x 40W  
↗ 98026/94



### 3. 12910/20

↑ ↔  
→ 140mm ø 80mm  
D45, E14, 1 x 40W  
↗ 98026/96





1 - 4



1 - 4

## Milos

old copper/white alabaster  
metal/glass

### 1. 17832/56

↑ 125mm ↔ 880mm  
→ 190mm ø  
R50, E14, 4 x 40W  
D45, E14, 4 x 40W  
↗ 92146/94



4 004353 034435



### 2. 17829/56

↑ 95mm ↔ 340mm  
→ 160mm ø  
R50, E14, 2 x 40W  
D45, E14, 2 x 40W  
↗ 92146/94



4 004353 034428



### 3. 17834/56

↑ 240mm ↔ 240mm  
→ 160mm ø  
R50, E14, 3 x 40W  
D45, E14, 3 x 40W  
↗ 92146/94



4 004353 034442



### 4. 17810/56

↑ 115mm ↔ 105mm  
→ 160mm ø 80mm  
R50, E14, 1 x 40W  
D45, E14, 1 x 40W  
↗ 92146/94



4 004353 034411





1 - 4



1 - 4

## Luca

old copper/champagne  
metal/glass

### 1. 35832/56

↑ 150mm ↔ 810mm  
→ 165mm ø  
R50, E14, 4 x 40W  
D45, E14, 4 x 40W  
↗92286/83



4 004353 036378

### 2. 35816/56

↑ 150mm ↔ 460mm  
→ 165mm ø  
R50, E14, 3 x 40W  
D45, E14, 3 x 40W  
↗92286/83



4 004353 036354

### 3. 35813/56

↑ 150mm ↔ 350mm  
→ 165mm ø  
R50, E14, 2 x 40W  
D45, E14, 2 x 40W  
↗92286/83



4 004353 036309

### 4. 35810/56

↑ 135mm ↔  
→ 145mm ø 85mm  
R50, E14, 1 x 40W  
D45, E14, 1 x 40W  
↗92286/83



4 004353 036279



SEE OTHER COLOUR  
ON PAGE  
**87**





1 - 4



1 - 4

## Sofia

old copper/red-orange  
metal/glass

### 1. 55331/19

‡ 130mm ↔ 700mm  
→ 175mm ø  
D45, E14, 4 x 40W  
↗92196/07



4 004353 056314



### 2. 55316/19

‡ 100mm ↔ 570mm  
→ 215mm ø  
D45, E14, 3 x 40W  
↗92196/07



4 004353 056291



### 3. 55313/19

‡ 100mm ↔ 330mm  
→ 215mm ø  
D45, E14, 2 x 40W  
↗92196/07



4 004353 056277



### 4. 55334/19

‡ ↔  
→ 185mm ø 200mm  
D45, E14, 3 x 40W  
↗92196/07



4 004353 056338



SEE OTHER COLOUR  
ON PAGE  
**88 - 89**



2



1-2

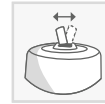

1

## Sofia

old copper/red-orange  
metal/glass

### 1. 55390/19

↑ ↓    ↔  
→370mm    ø 90mm  
D45, E14, 1 x 40W  
92196/07



4 004353 056352

### 2. 55310/19

↑ ↓    ↔  
→190mm    ø 80mm  
D45, E14, 1 x 40W  
92196/07



4 004353 056253





1 - 4



1 - 4

## Sofia

brass/white alabaster  
metal/glass

### 1. 55331/18

‡ 130mm ↔700mm  
→175mm ø  
D45, E14, 4 x 40W  
↗92196/94



4 004353 056307



### 2. 55316/18

‡ 100mm ↔570mm  
→215mm ø  
D45, E14, 3 x 40W  
↗92196/94



4 004353 056284



### 3. 55313/18

‡ 100mm ↔330mm  
→215mm ø  
D45, E14, 2 x 40W  
↗92196/94



4 004353 056260



### 4. 55334/18

‡ ↔  
→185mm ø 200mm  
D45, E14, 3 x 40W  
↗92196/94



4 004353 056321



SEE OTHER COLOUR  
ON PAGE  
**88 - 89**



2



1-2

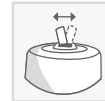

1

## Sofia

brass/white alabaster  
metal/glass

### 1. 55390/18

↑ ↓  
→ ← 370mm ø 90mm  
D45, E14, 1 x 40W  
92196/94



### 2. 55310/18

↑ ↓  
→ ← 190mm ø 80mm  
D45, E14, 1 x 40W  
92196/94





1



1-3



2



3

## Minor

white  
metal/plastic

### 1. 06310T05

↑ ↓ ↔  
→ 190mm ø 90mm  
R63, E27, 1 x 60W



4 004353 606809

### 2. 06311/05

↑ ↓ ↔  
→ 190mm ø 90mm  
R63, E27, 1 x 60W



4 004353 912542

### 3. 06301T05

↑ ↓ ↔  
→ 190mm ø  
R63, E27, 1 x 60W



4 004353 606786

1



2



3





1-3



1-3

## Minor

white  
metal/plastic

### 1. 06330T05

‡ 50mm ↔ 590mm  
→ 130mm ø  
R63, E27, 3 x 60W



### 2. 06329T05

‡ 50mm ↔ 380mm  
→ 190mm ø  
R63, E27, 2 x 60W



### 3. 06334T05

‡                   ↔  
→ 190mm ø 260mm  
R63, E27, 3 x 60W

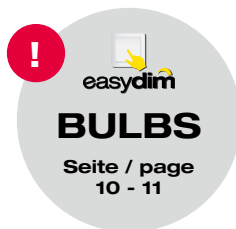



1-4



1-5



5

## Minor

black  
metal/plastic

### 1. 06330T06

↑ 50mm ↔ 590mm  
→ 130mm ø  
R63, E27, 3 x 60W



4 004353 606878



### 2. 06329T06

↑ 50mm ↔ 380mm  
→ 190mm ø  
R63, E27, 2 x 60W



4 004353 606854



### 3. 06334T06

↑ ↔  
→ 190mm ø 260mm  
R63, E27, 3 x 60W



4 004353 606892



### 4. 06310T06

↑ ↔  
→ 190mm ø 90mm  
R63, E27, 1 x 60W



4 004353 606816



### 5. 06301T06

↑ ↔  
→ 190mm ø 90mm  
R63, E27, 1 x 60W



4 004353 606793







1 - 4



1 - 4

## Minor

titanium  
metal/plastic

### 1. 06330/11

↑ 50mm ↔ 590mm  
→ 130mm ø  
R63, E27, 3 x 60W



### 2. 06329/11

↑ 50mm ↔ 380mm  
→ 190mm ø  
R63, E27, 2 x 60W



### 3. 06334/11

↑ ↔  
→ 190mm ø 260mm  
R63, E27, 3 x 60W



### 4. 06310/11

↑ ↔  
→ 190mm ø 90mm  
R63, E27, 1 x 60W





1-3



1-4



4

## Cosmos

white  
metal/plastic

### 1. 07529T05

↑ ↔ 380mm  
→ 200mm ø  
R80, E27, 2 x 60W  
PAR25, E27, 2 x 75W



4



### 2. 07534T05

↑ ↔  
→ 200mm ø 270mm  
R80, E27, 3 x 60W  
PAR25, E27, 3 x 75W



4



### 3. 07510T05

↑ ↔  
→ 200mm ø 90mm  
R80, E27, 1 x 60W  
PAR25, E27, 1 x 75W



4



### 4. 07501T05

↑ ↔  
→ 200mm ø  
R80, E27, 1 x 60W  
PAR25, E27, 1 x 75W



4



SPOTS





1-3



1-3

## Puck

white  
metal/plastic

### 1. 36429/05

↑                    ↔ 380mm  
→ 170mm ø  
R50, E14, 2 x 40W



### 2. 36434/05

↑                    ↔  
→ 180mm ø 260mm  
R50, E14, 3 x 40W



### 3. 36410/05

↑                    ↔  
→ 80mm    ø 75mm  
R50, E14, 1 x 40W





1-3



1-3

## Troll

white  
metal/plastic

### 1. 36329/05

↑                    ↔ 380mm  
→ 190mm ø  
R63, E27, 2 x 60W



4 004353 920370

### 2. 36334/05

↑                    ↔  
→ 190mm ø 270mm  
R63, E27, 3 x 60W



4 004353 920417

### 3. 36310/05

↑                    ↔  
→ 190mm ø 90mm  
R63, E27, 1 x 60W



4 004353 920356







# DECORATIVE





1-2



1-2

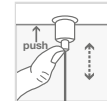

2

## Donut

chrome/white  
metal/acrylic

### 1. G04090/15

↓ 80mm ↔  
→ ø 430mm  
LED integr., 1 x 22W   
1 x 1680 lm, 3000 K, **A**  
↗ 98348/00



4 004353 216374

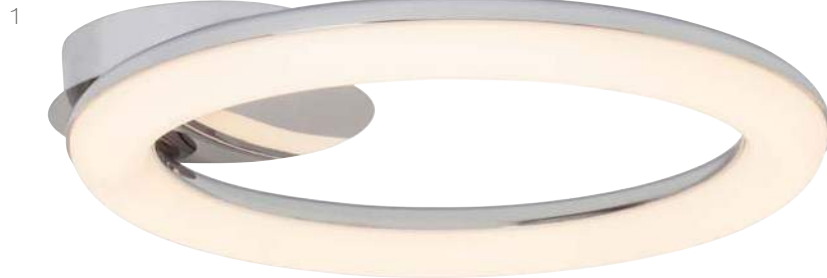

### 2. G04073/15

↓ 1500mm ↔ 770mm  
→ 90mm ø  
LED integr., 5 x 4.2W   
5 x 270 lm, 3000 K, **A**  
↗ 98352/00



4 004353 216428

1680  
LUMEN



2

1350  
LUMEN



DECORATIVE





1-2



1-2

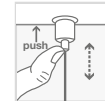

1-2

## Donut

chrome/white  
metal/acrylic

### 1. G04070/15

- ‡ 1500mm ↔
- ø 430mm
- LED integr., 1 x 31W
- 1 x 2300 lm, 3000 K, **A**
- ↗ 98350/00



4 004353 216404

### 2. G04076/15

- ‡ 1500mm ↔
- ø 475mm
- LED integr., 3 x 8,7W
- 3 x 583 lm, 3000 K, **A**
- ↗ 98351/00



4 004353 216411

1



2



1750  
LUMEN



2300  
LUMEN



**LED**  
incl.

1-2

**DIMMABLE**

1-2

## Donut

chrome/white  
metal/plastic

### 1. G04091/15

↑ 280mm ↔  
→ ø 430mm  
LED integr., 1 x 22W   
1 x 1680 lm, 3000 K, **A**<sup>+</sup>  
↗ 98348/00



### 2. G04095/15

↑ 175mm ↔  
→ ø 680mm  
LED integr., 5 x 8.7W   
5 x 660 lm, 3000 K, **A**<sup>+</sup>  
↗ 98349/00



1680  
LUMEN



3300  
LUMEN



**LED**  
incl.

1-2

incl.

2

## Beach

chrome/white  
metal/acrylic

### 1. G94453/15 ☺

↑ 140mm ↔ 1015mm  
→ 115mm ø  
LED integr., 1 x 27,7W   
1 x 2610 lm, 3000 K, **A+**  
↗ 98265/00



4 004353 247897



2610  
LUMEN

### 2. G94454/15 ☐

↑ 1445mm ↔  
→ ø 220mm  
LED integr., 1 x 27,9W   
1 x 2315 lm, 3000 K, **A+**  
↗ 98266/00



4 004353 247903

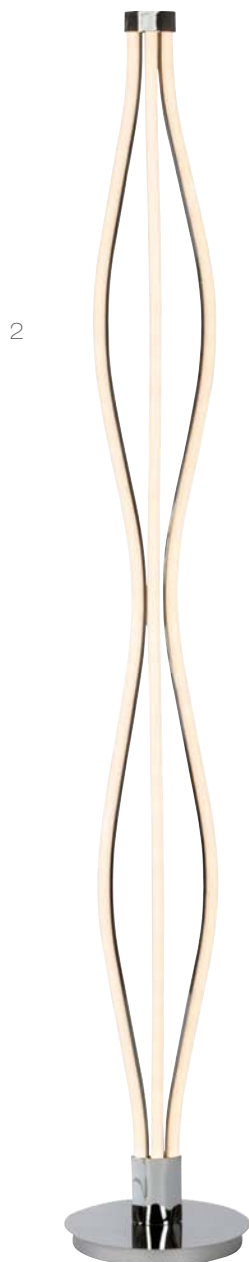

2315  
LUMEN

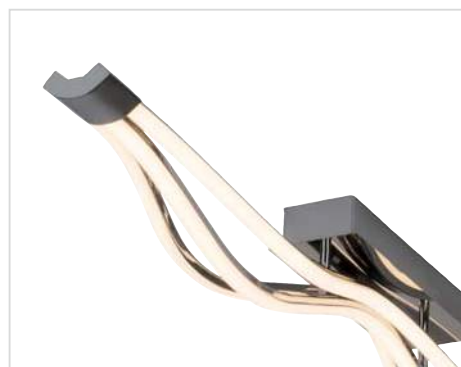

**LED**  
incl.

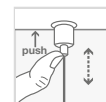

1-2

2

## Circle

chrome/white  
metal/acrylic

### 1. G94440/15

↑ 534mm ↔  
→ ø 490mm  
LED integr., 1 x 35,6W   
1 x 3150 lm, 3000 K, **A+**  
↗ 98365/00



### 2. G94465/15

↑ 1300mm ↔ 1200mm  
→ 420mm ø  
LED integr., 1 x 30W   
1 x 2410 lm, 3000 K, **A**  
↗ 98282/00



**3150**  
LUMEN



**2410**  
LUMEN





## Tube

chrome/white  
metal/acrylic

### 1. G61870/05

↓ 1200mm ↔ 1000mm  
→ 70mm ø  
LED integr., 1 x 20,5W   
1 x 1685 lm, 3000 K, **A**  
↗ 98158/00



### 2. G61890/05

↓ ↔ 600mm  
→ 110mm ø  
LED integr., 1 x 13W   
1 x 1065 lm, 3000 K, **A**



### 3. G61849/05

↓ 415mm ↔  
→ ø 150mm  
LED integr., 1 x 8,6W   
1 x 602 lm, 3000 K, **A**

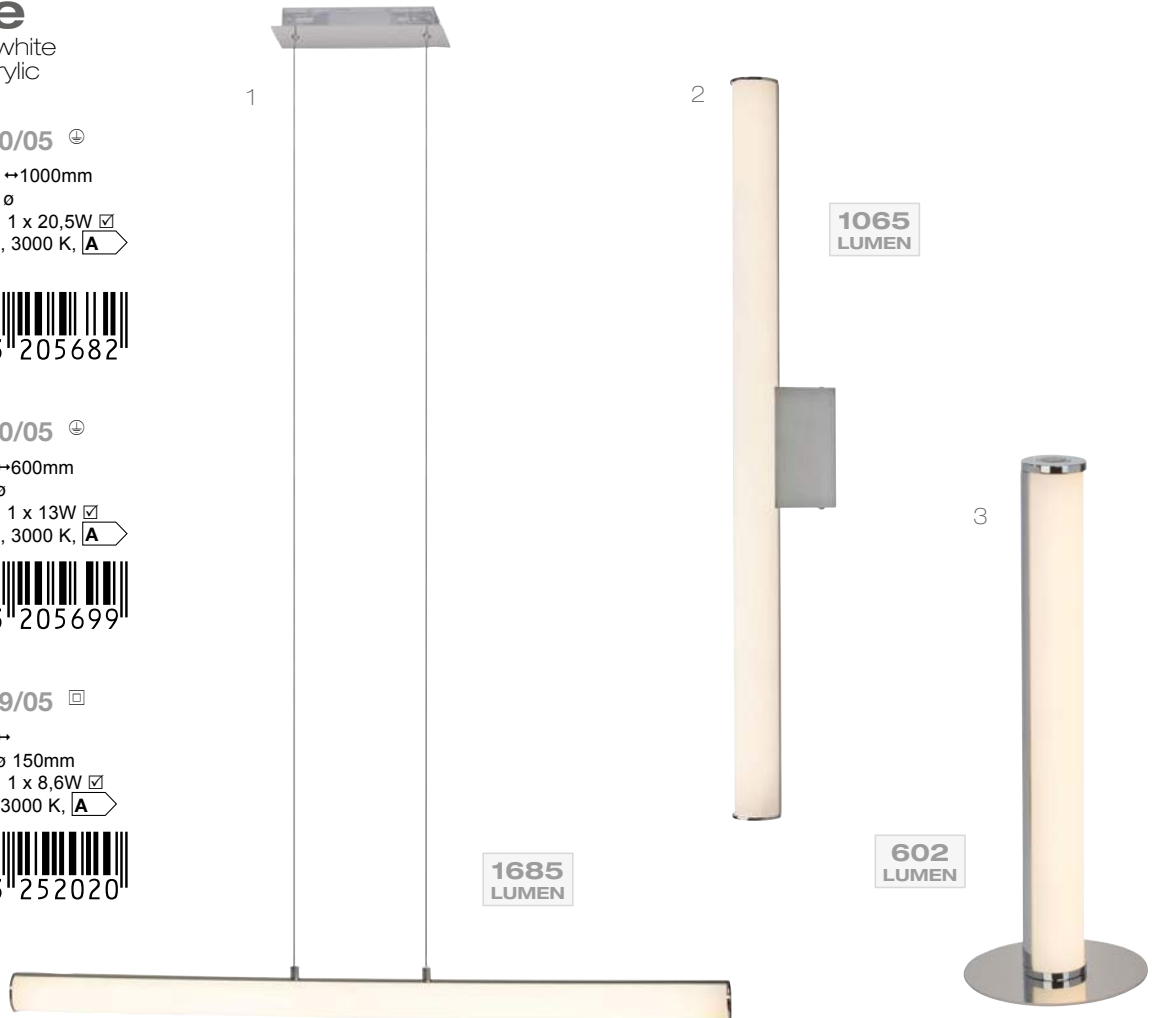



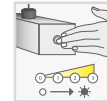

# Tube

chrome/white  
metal/acrylic

1. G61858/05 

↑ 1420mm ↔

→ ø 200mm

LED integr., 1 x 30W 

1 x 2790 lm, 3000 K, 

↗ 98159/00

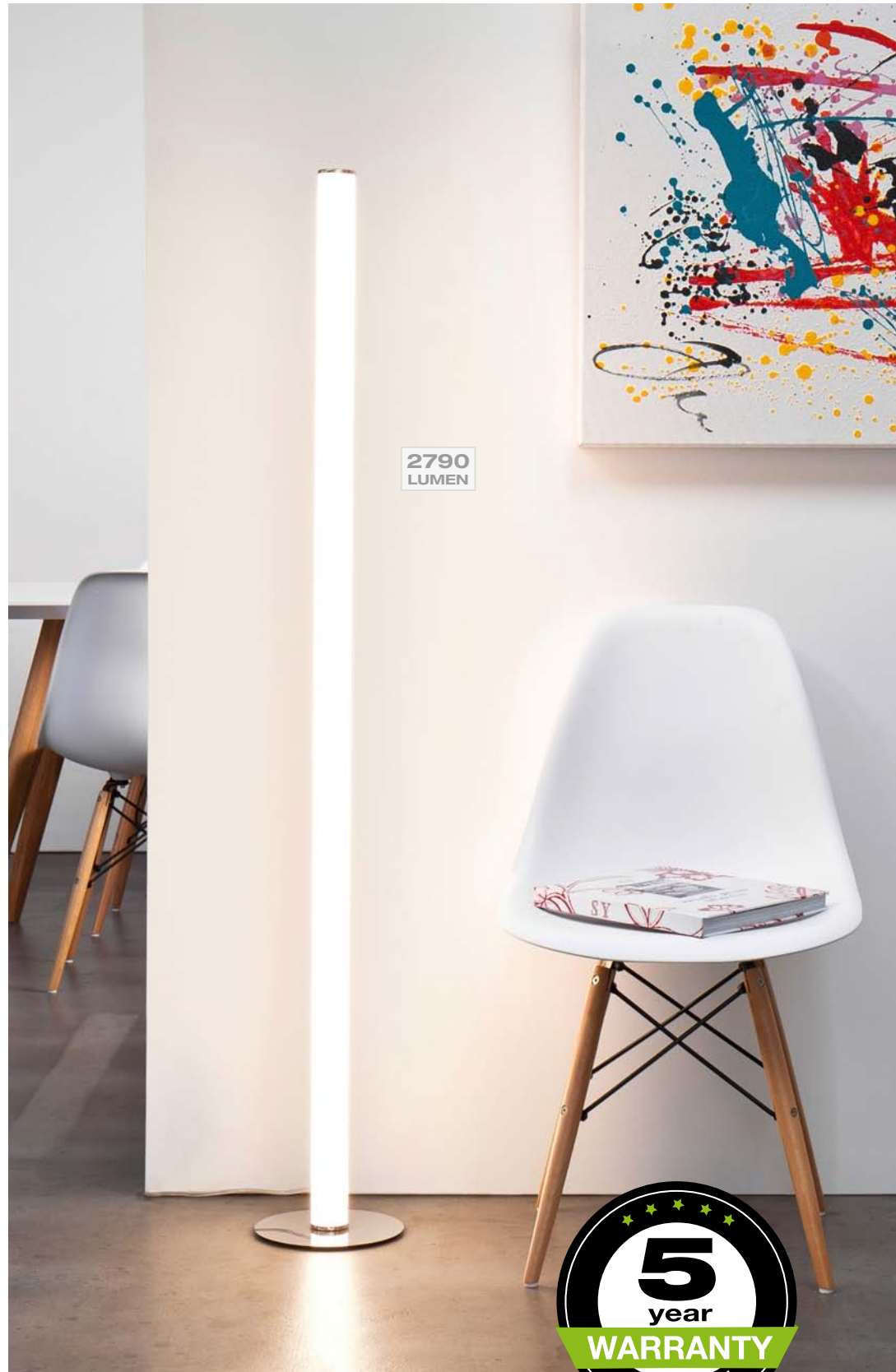

2790  
LUMEN



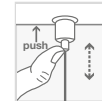
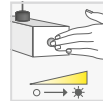

1-4

2

3

4

## View

chrome/white  
metal/acrylic

### 1. G93538/15

↑ 190mm ↔ 1010mm  
→ 15mm ø  
LED integr., 1 x 23,5W   
1 x 1800 lm, 3000 K, **A**  
↗ 98336/00



### 2. G93568/15

↑ ↔ 335mm  
→ 90mm ø  
LED integr., 1 x 7W   
1 x 480 lm, 3000 K, **A**



### 3. G93556/15

↑ 1250mm ↔ 80mm  
→ 15mm ø 200mm  
LED integr., 1 x 26,7W   
1 x 1970 lm, 3000 K, **A**  
↗ 98337/00, 98338/00

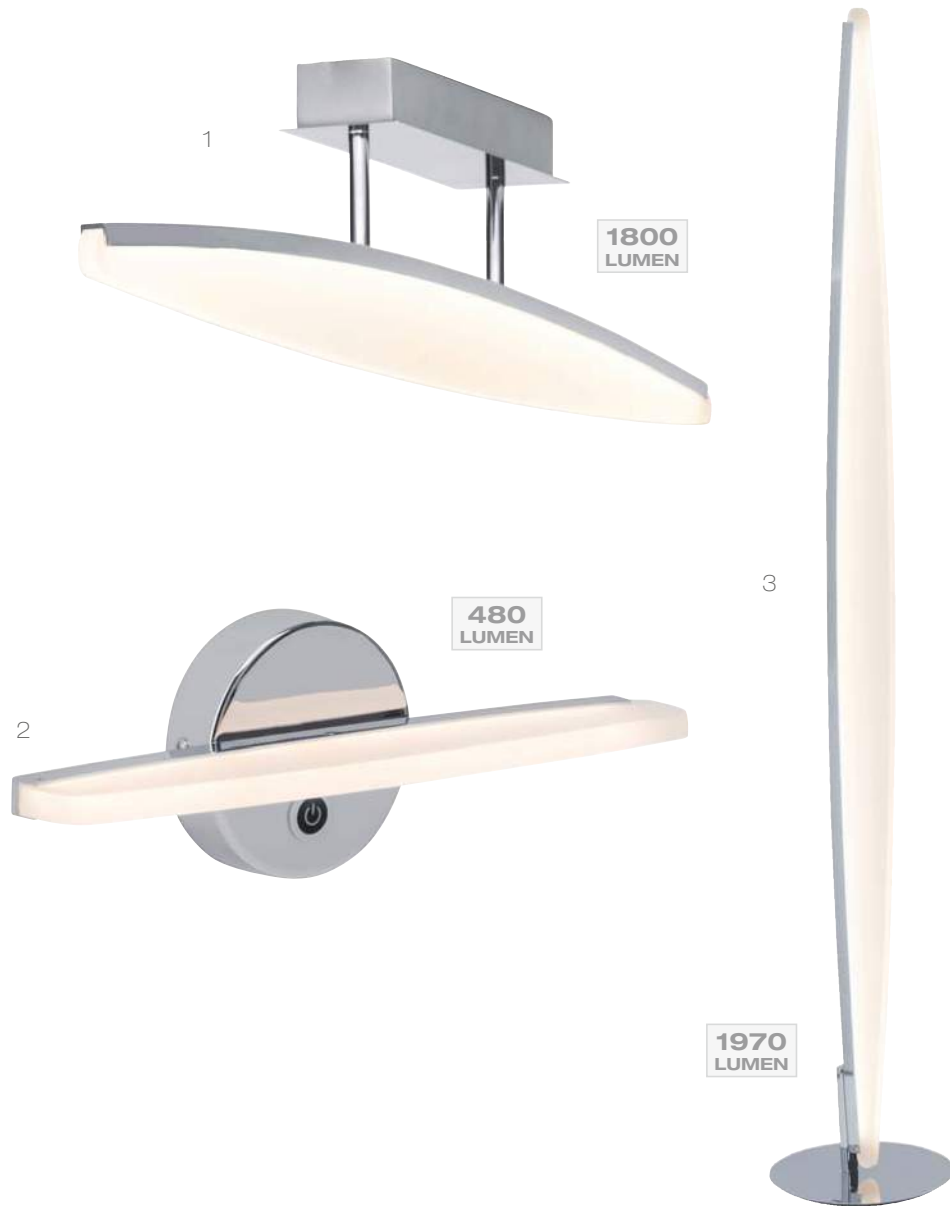

### 4. G93537/15

↑ 1500mm ↔ 1010mm  
→ 15mm ø  
LED integr., 1 x 23,5W   
1 x 1800 lm, 3000 K, **A**  
↗ 98336/00





1-2



1-2



1-2

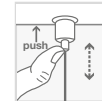

2

# Sunrise Light

chrome  
metal/acrylic

## 1. G93653/15

↓ 153mm ↔ 1150mm  
→ 80mm ø  
LED integr., 1 x 31W   
1 x 2610 lm, 3000 K, **A**  
↗ 98317/00



4



## 2. G93596/15

↓ 1500mm ↔ 1150mm  
→ 80mm ø  
LED integr., 1 x 29,7W   
1 x 2610 lm, 3000 K, **A+**  
↗ 98354/00



4

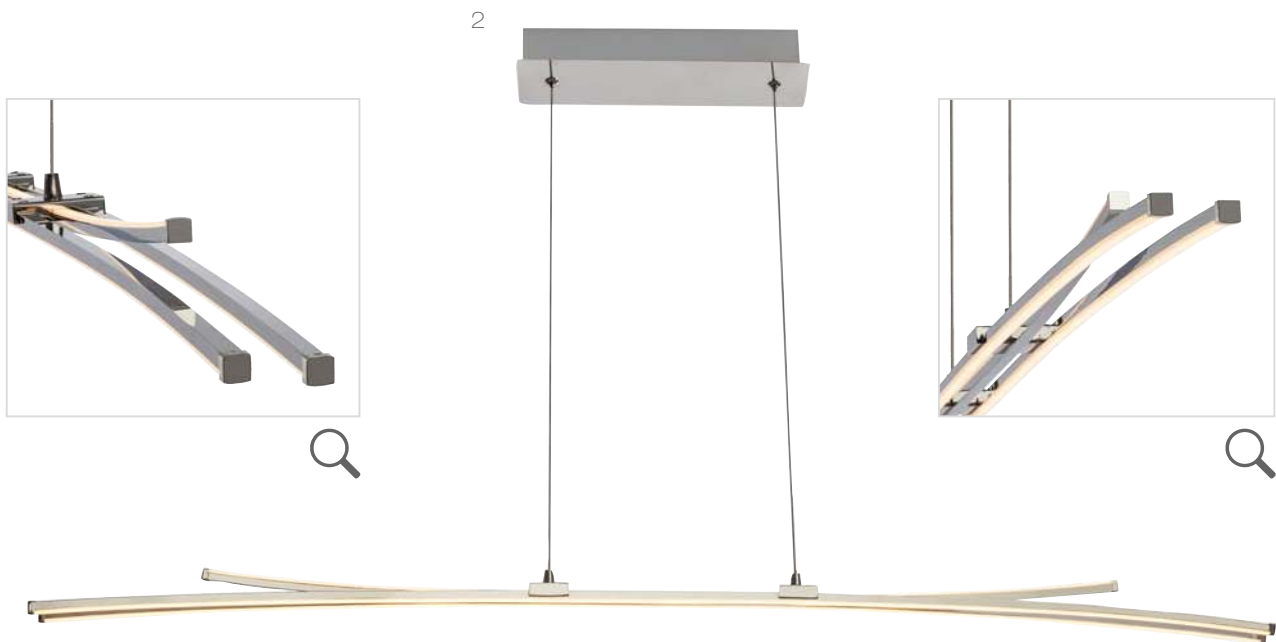

2610  
LUMEN





1-2

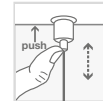

1



2

# Delta II

chrome/white  
metal/acrylic

## 1. G93625/15

↑ 1260mm ↔ 1002mm  
→ 80mm ø  
LED integr., 1 x 23W   
1 x 1775 lm, 3000 K, **A**  
↗ 98288/00



4 004353 249884

## 2. G93626/15

↑ 1315mm ↔ 220mm  
→ 150mm ø  
LED integr., 1 x 27,3W   
1 x 2160 lm, 3000 K, **A**  
↗ 98289/00



4 004353 249891

1



2

2160  
LUMEN



1775  
LUMEN



**LED**  
incl.

1-2

incl.  

1

## Gate

chrome/white  
metal/acrylic

### 1. G93507/15

↑ 1500mm ↔ 890mm  
→ 140mm ø  
LED integr., 4 x 6.4W   
4 x 455 lm, 3000 K, **A+**  
↗ 98157/00



### 2. G93508/15

↑ 53mm ↔ 380mm  
→ 380mm ø  
LED integr., 4 x 6.4W   
4 x 455 lm, 3000 K, **A+**  
↗ 98157/00



**1820**  
LUMEN

**1820**  
LUMEN

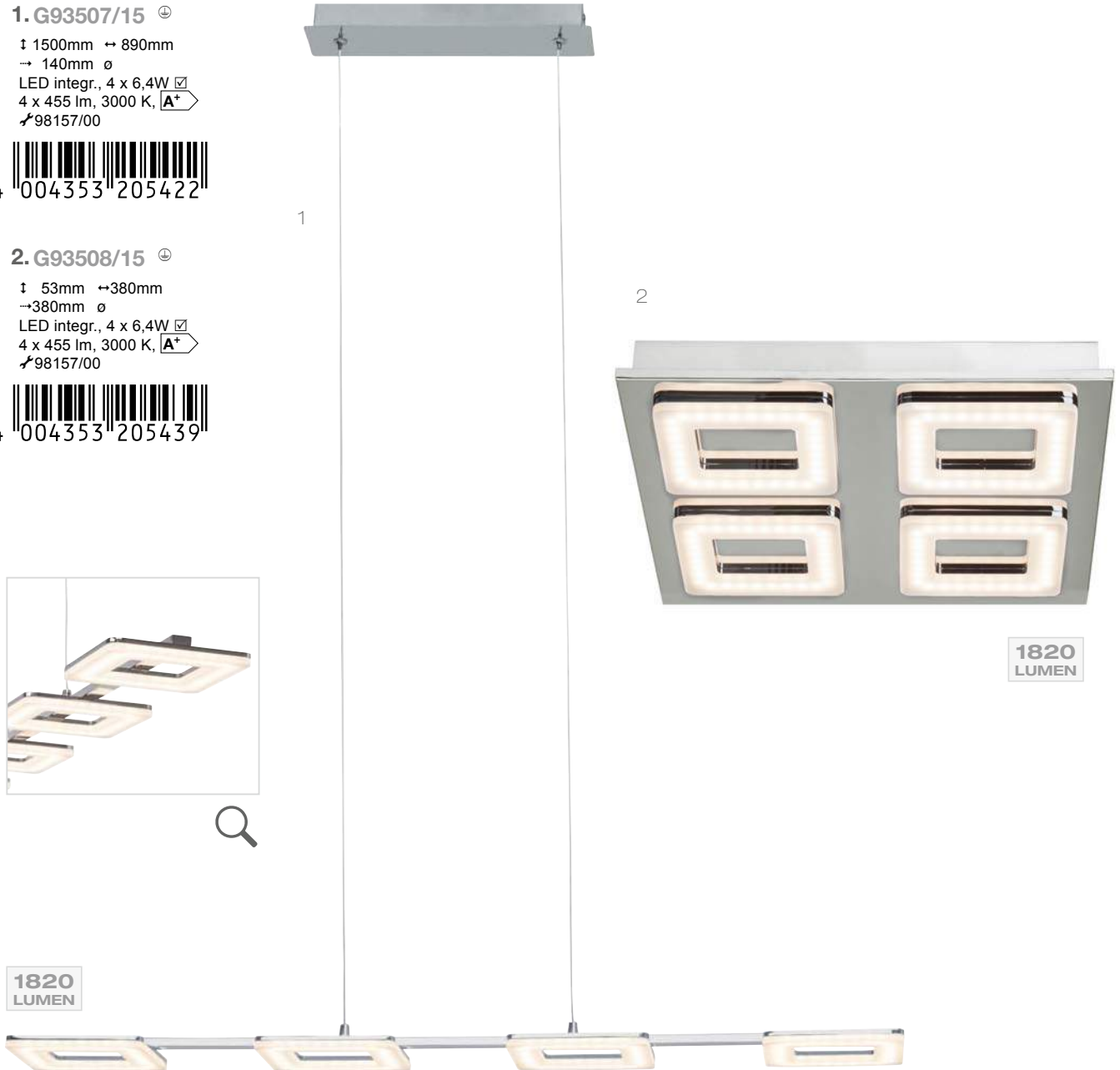



1-2



1-2



1-2

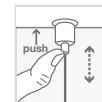

2

## Sailing

chrome  
metal/glass

### 1. G93644/15

↑ 88mm ↔ 1190mm  
→ 260mm ø

LED integr., 6 x 4W   
6 x 400 lm, 3100 K, **A+**  
↗ 98306/00, 98307/00

2400  
LUMEN



### 2. G93586/15

↑ 1180mm ↔ 1205mm  
→ 100mm ø

LED integr., 5 x 6W   
5 x 600 lm, 3100 K, **A+**  
↗ 98306/00, 98363/00



3000  
LUMEN



1-2



1





2

## Salamanca

chrome  
metal/plastic



### 1. G17979/15

↑ 470 - 830mm ↔ 1000mm  
→ 90mm ø  
LED integr., 1 x 20W   
1 x 1500 lm, 3000 K, 



4 004353 174445

### 2. G17942/15

↑ 430mm ↔  
→ 230mm ø 150mm  
LED integr., 2 x 5W   
2 x 375 lm, 3000 K, 



4 004353 174438

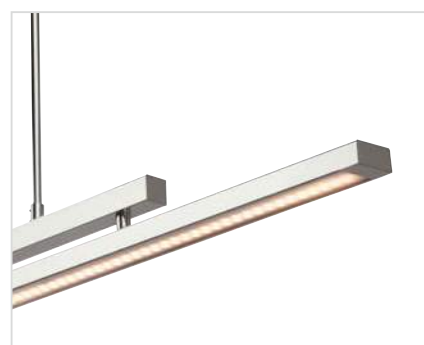





1-2



1

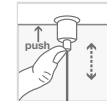

1

## DNA

satin nickel  
metal/acrylic

### 1. G94469/13

‡ 1210mm ↔ 1245mm  
→ 130mm ø  
LED integr., 1 x 29,2W   
1 x 2800 lm, 3000 K, **A+**  
↗ 98291/00



4 004353 249952

### 2. G94468/13

‡ 430mm ↔ 140mm  
→ 138mm ø  
LED integr., 1 x 14,3W   
1 x 1060 lm, 3000 K, **A**  
↗ 98290/00



4 004353 249945

1



2800  
LUMEN

2



1060  
LUMEN

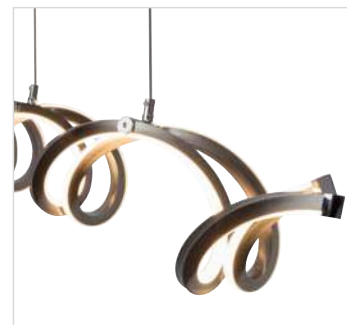



1-2

1

2

## DNA

satin nickel  
metal/acrylic

### 1. G94470/13

↑ 164mm ↔ 1245mm  
→ 130mm ø  
LED integr., 1 x 29,7W   
1 x 2800 lm, 3000 K, **A+**  
↗ 98291/00



2800  
LUMEN

### 2. G94471/13

↑ 1355mm ↔ 175mm  
→ 175mm ø  
LED integr., 1 x 22,3W   
1 x 1945 lm, 3000 K, **A+**  
↗ 98292/00



1945  
LUMEN





1-3



2

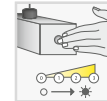

3

## Slide

satin nickel/white  
metal/acrylic

### 1. G94323/13

‡ 63mm ↔1200mm  
→220mm ø  
LED integr., 1 x 21,6W   
1 x 1940 lm, 3000 K, **A+**



4 004353 205712



1940  
LUMEN

### 2. G94947/13

‡ 1290mm ↔300mm  
→ 210mm ø  
LED integr., 1 x 31W   
1 x 2695 lm, 3000 K, **A+**



4 004353 251269

2



### 3. G94946/13

‡ 405mm ↔190mm  
→150mm ø  
LED integr., 1 x 9,1W   
1 x 600 lm, 3000 K, **A**



4 004353 251290

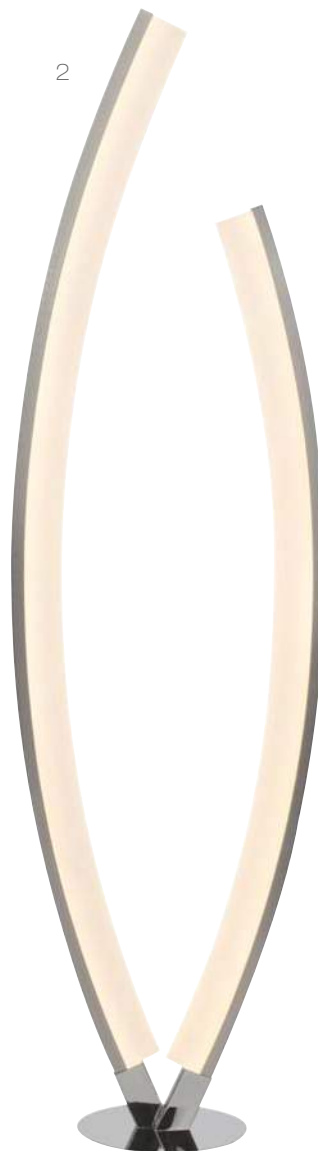

2695  
LUMEN

3



600  
LUMEN



DECORATIVE





1-3

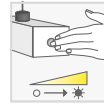

1-3

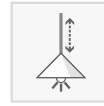

1



1

## Art Work

aluminium  
aluminium/acrylic

### 1. G65172/21

↑ 850 - 1500mm ↔ 900mm  
→ 80mm ø  
LED integr., 6 x 4,5W   
6 x 360 lm, 3000 K, **A+**  
↗ 98160/00



1

↑ 850 - 1500 mm

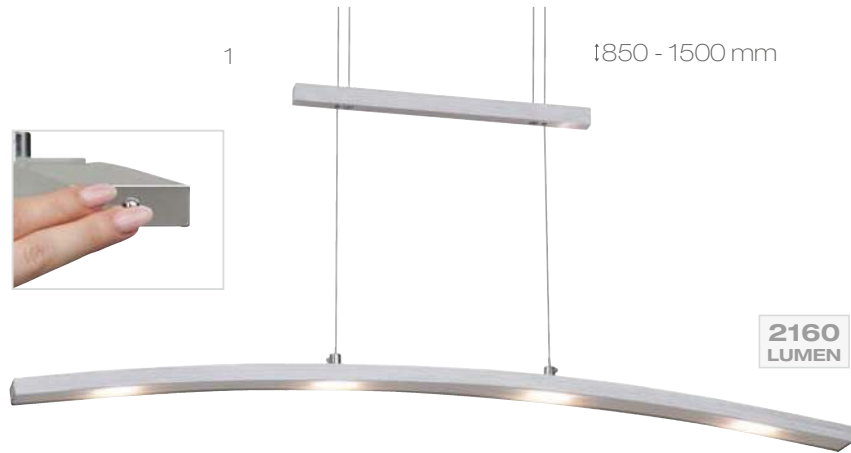

2160  
LUMEN

### 2. G65156/21

↑ 1560mm ↔  
→ ø 230mm  
LED integr., 1 x 27W   
1 x 2160 lm, 3000 K, **A**  
↗ 98333/00, 98334/00



2

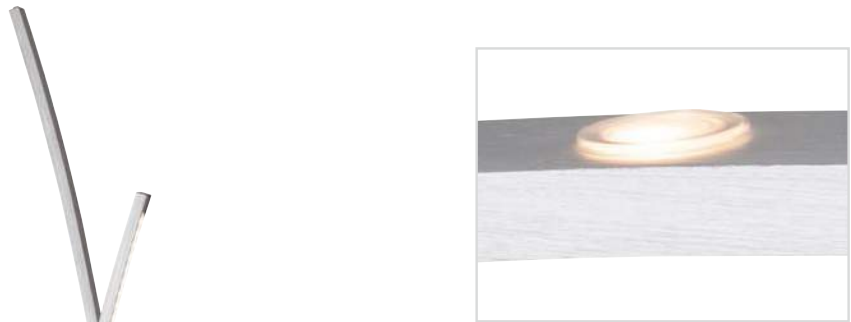

### 3. G65142/21

↑ 450mm ↔  
→ ø 130mm  
LED integr., 1 x 12W   
1 x 960 lm, 3000 K, **A**  
↗ 98335/00



2160  
LUMEN

3



960  
LUMEN



DECORATIVE





1-4



2



3



4

## Mirella

chrome/white  
metal/glass

### 1. G39695/75

↑ 180mm ↔ 660mm  
→ 360mm ø  
LED, G9, 5 x 3W   
5 x 250 lm, 2800 K, **A+**  
↗ 92557/05



4 004353 197956



1250  
LUMEN

### 2. G93454/75

↑ 600 - 1000mm ↔  
→ ø580mm  
LED, G9, 6 x 3W   
6 x 250 lm, 2800 K, **A+**  
↗ 92592/05



4 004353 194139

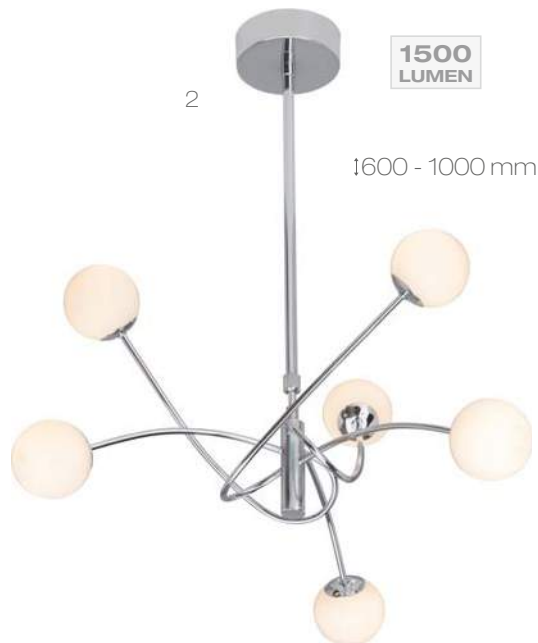

1500  
LUMEN

1600 - 1000 mm

### 3. G39642/75

↑ 335mm ↔  
→ 205mm ø 100mm  
LED, G9, 2 x 3W   
2 x 250 lm, 2800 K, **A+**  
↗ 92557/05



4 004353 197949



500  
LUMEN

### 4. G39654/75

↑ 1670mm ↔  
→ 230mm ø 250mm  
LED, 4 x 3W   
250 lm, 2800 K, **A+**  
↗ 92557/05



4 004353 256929



1000  
LUMEN





1-2



1



2

## Lea

satin nickel/chrome/white/transparent  
metal/glass

### 1. G32473/77

↑ 750 - 1600mm ↔ 900mm  
→ ∅  
LED, E14, 5 x 3W   
5 x 260 lm, 3000 K, **A+**  
↗ 98043/91



4 004353 194283

### 2. G32459/77

↑ 1600mm ↔  
→ ∅220mm  
LED, E14, 3 x 3W   
3 x 260 lm, 3000 K, **A+**  
↗ 98043/91



4 004353 195464



SEE OTHER VERSIONS  
ON PAGE  
**44**



1 - 4



1 - 4

# Philo

satin nickel/brushed brass/white metal/glass

## 1. G16348/13

↑ 420mm ↔  
→ 260mm ø150mm  
LED, E14, 1 x 3W   
1 x 250 lm, 3000 K, **A+**  
↗ 98001/05



4 004353 175329

## 2. G16348/18

↑ 420mm ↔  
→ 260mm ø150mm  
LED, E14, 1 x 3W   
1 x 250 lm, 3000 K, **A+**  
↗ 98001/05



4 004353 175336

## 3. G16358/13

↑ 1400mm ↔  
→ 600mm ø225mm  
LED, E14, 1 x 3W   
1 x 250 lm, 3000 K, **A+**  
↗ 98001/05



4 004353 175343

## 4. G16358/18

↑ 1400mm ↔  
→ 600mm ø225mm  
LED, E14, 1 x 3W   
1 x 250 lm, 3000 K, **A+**  
↗ 98001/05



4 004353 175350

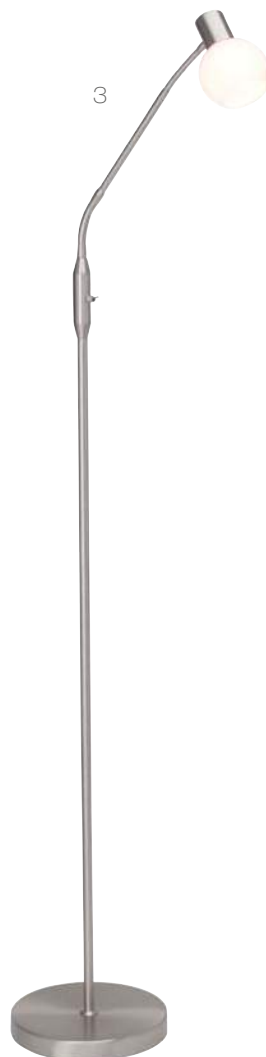

SEE OTHER VERSIONS  
ON PAGE  
**48**

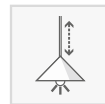

# Philo

satin nickel/white  
metal/glass

1. G16372/13

↑ 1080 - 2600mm ↔ 610mm

→  
LED, E14, 4 x 3W  
4 x 250 lm, 3000 K, A+  
98001/05

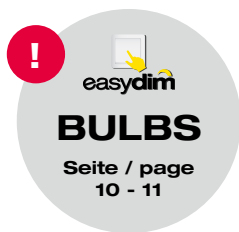

4 004353 170614

**easydim**  
**BULBS**  
Seite / page  
10 - 11



1-2



1-2



1

# Brilliance

chrome  
glass/metal

## 1. 93621/15

↑ 1540mm ↔  
→ ø 500mm  
QT14, G9, 6 x 33W  
/ 98272/15, 98274/00,  
98275/00, 98276/00,  
98277/00, 98278/00,  
323171-15



4 004353 249143

## 2. 93623/15

↑ 345mm ↔  
→ ø 500mm  
QT14, G9, 6 x 33W  
/ 98272/15, 98274/00,  
98275/00, 98276/00,  
98277/00, 98278/00,  
323173-15



4 004353 249167





# Brilliance

chrome  
glass/metal

## 1. 93620/15

‡ 1540mm ↔  
→ ø 400mm  
QT14, G9, 5 x 33W  
98270/15, 98274/00,  
98275/00, 98276/00,  
98277/00, 98278/00



## 2. 93622/15

‡ 315mm ↔  
→ ø 400mm  
QT14, G9, 5 x 33W  
98270/15, 98274/00,  
98275/00, 98276/00,  
98277/00, 98278/00





1-2



1-2



1

# Brilliance

copper  
glass/metal

## 1. 93621/29

‡ 1570mm ↔  
→ ø 500mm  
QT14, G9, 6 x 33W  
98272/00, 98274/00,  
98275/00, 98276/00,  
98277/00, 98278/00



4 004353 249136

## 2. 93623/29

‡ 345mm ↔  
→ ø 500mm  
QT14, G9, 6 x 33W  
98272/29, 98274/00,  
98275/00, 98276/00,  
98277/00, 98278/00



4 004353 249174





1-2



1-2

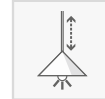

1

# Brilliance

copper  
glass/metal

## 1. 93620/29

↑ 1540mm ↔  
→ ø 400mm  
QT14, G9, 5 x 33W  
98270/29, 98274/00,  
98275/00, 98276/00,  
8277/00, 98278/00



4 004353 249105

## 2. 93622/29

↑ 315mm ↔  
→ ø 400mm  
QT14, G9, 5 x 33W  
98270/29, 98274/00,  
98275/00, 98276/00,  
98277/00, 98278/00



4 004353 249198







1-2



1-2



1



2

## Sky

chrome  
glass/metal

### 1. 32072/15

‡ 1510mm ↔ 370mm  
→ 840mm ø  
A60, E27, 2 x 60W  
♣98313/15



### 2. 32070/15

‡ 1510mm ↔  
→ ø 370mm  
A60, E27, 1 x 60W  
♣98313/15

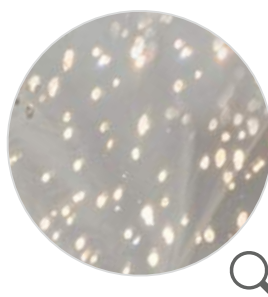



1-2



1-2



1



2

## Sky

copper  
glass/metal

### 1. 32072/29

↑ 1510mm ↔ 370mm  
→ 840mm ∅  
A60, E27, 2 x 60W  
98313/29



### 2. 32070/29

↑ 1510mm ↔  
→ ∅ 370mm  
A60, E27, 1 x 60W  
98313/29

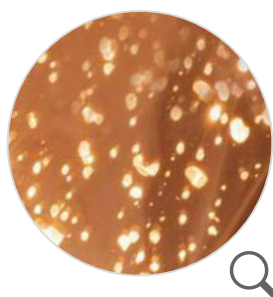



1-2



1-2

# Sky

chrome/copper  
glass/metal

1. 32049/15

↑ 515mm    ↔  
→            ⌀ 260mm  
D45, E14, 2 x 40W  
↗ 98311/15



4 004353 251153

2. 32049/29

↑ 515mm    ↔  
→            ⌀ 260mm  
D45, E14, 2 x 40W  
↗ 98311/29



4 004353 251160

1



2

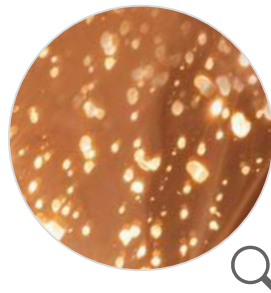

**BULBS**  
Seite / page  
10 - 11

**5**  
year  
**WARRANTY**  
BRILLIANT



1-2



1-2

## Sky

chrome/copper  
glass/metal

### 1. 32010/15

‡ 275mm ↔280mm  
→140mm ø  
A60, E27, 1 x 60W



1

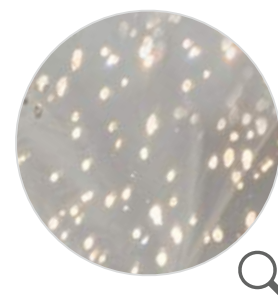

### 2. 32010/29

‡ 275mm ↔280mm  
→140mm ø  
A60, E27, 1 x 60W



2

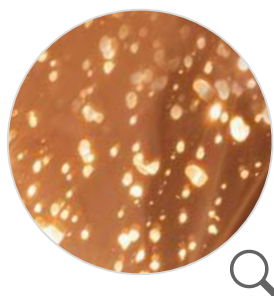



1-3



1-2

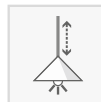

1



3

# Waterfall

smoked glass  
metal/glass

## 1. 93657/93

‡ 1450mm ↔  
→ ø 400mm  
QT14, G9, 5 x 42W  
↗ 98323/93, 98325/00,  
98326/00, 98327/00



4 004353 249723

1



## 2. 93656/93

‡ 220mm ↔  
→ ø 400mm  
QT14, G9, 5 x 42W  
↗ 98323/93, 98325/00,  
98326/00, 98327/00



4 004353 249716

2



## 3. 93658/93

‡ 360mm ↔  
→ ø 220mm  
QT14, G9, 3 x 28W  
↗ 98324/93, 98328/00,



4 004353 249730

3





DECORATIVE





1-2



3

## Magic

chrome/red copper  
metal/glass

### 1. 18093/79

↑ 140mm ↔  
→ ø 480mm  
QT14, G9, 3 x 28W  
↗ 98219/00, 98220/15,  
98221/29



4 004353 238970



### 2. 18095/79

↑ 140mm ↔  
→ ø 580mm  
QT14, G9, 5 x 28W  
↗ 98219/00, 98220/15,  
98221/29



4 004353 238987



### 3. 18048/79

↑ 375mm ↔ 220mm  
→ 130mm ø  
QT14, G9, 1 x 28W  
↗ 98219/00, 98220/15,  
98221/29



4 004353 239038





DECORATIVE

  
Brilliant





1-2



1-2

## Magic

chrome/red copper  
metal/glass

### 1. 18074/79

↑ 1300mm ↔ 840mm  
→ 140mm ∅  
QT14, G9, 4 x 28W  
↗ 98219/00, 98220/15,  
98221/29



4 004353 239014

### 2. 18075/79

↑ 1410mm ↔  
→ ∅ 320mm  
QT14, G9, 5 x 28W  
↗ 98219/00, 98220/15,  
98221/29



4 004353 239021

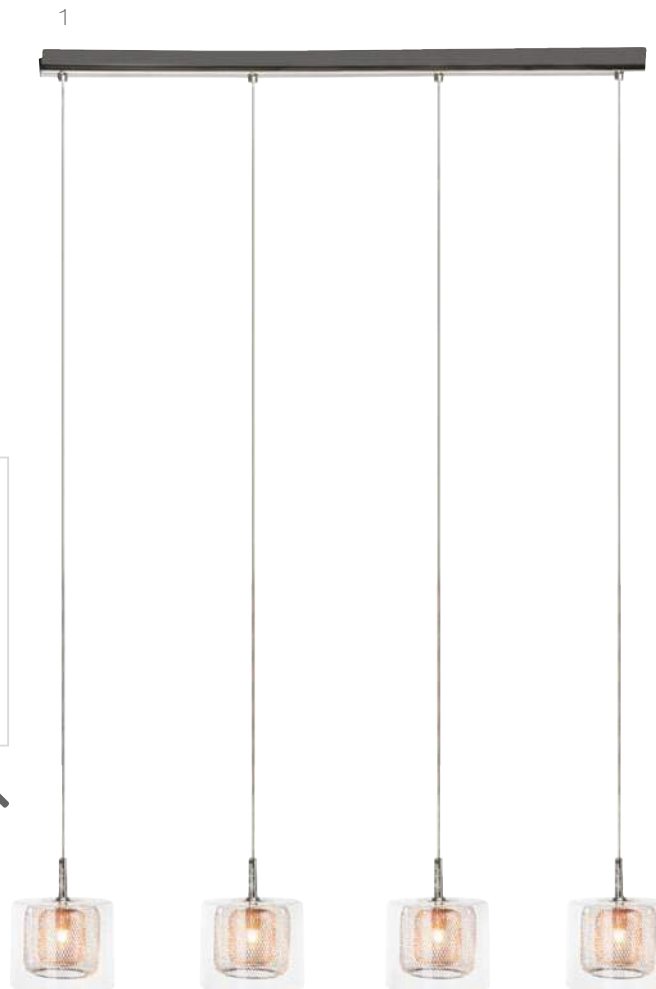

2





1-2



1-2

## Magic

chrome/red copper  
metal/glass

### 1. 18073/79

‡ 1300mm ↔ 625mm  
→ 140mm ∅  
QT14, G9, 3 x 28W  
98219/00, 98220/15,  
98221/29



4 004353 239007

### 2. 18070/79

‡ 1400mm ↔  
→ ∅ 140mm  
QT14, G9, 1 x 28W  
98219/00, 98220/15,  
98221/29



4 004353 238994





1-2



1-2

## Vegas

chrome/red copper  
metal/plastic

### 1. 17674/79

↓ 1370mm    ↔ 840mm  
→            ∅  
QT14, G9, 4 x 33W  
↗ 98212/79



4 004353 238949

### 2. 17675/79

↓ 1415mm    ↔  
→            ∅ 320mm  
QT14, G9, 5 x 33W  
↗ 98212/79



4 004353 238932





1-3

## Vegas

chrome/red copper  
metal/plastic

### 1. 17695/79

↑ 160mm ↔  
→ ø 520mm  
QT14, G9, 5 x 33W  
↗ 98212/79



1



### 2. 17693/79

↑ 155mm ↔  
→ ø 410mm  
QT14, G9, 3 x 33W  
↗ 98212/79



2



### 3. 17690/79

↑ 500mm ↔ 130mm  
→ 260mm ø  
QT14, G9, 1 x 33W  
↗ 98212/79



3





1-2



1-2

# Vegas

chrome  
metal/plastic

## 1. 17674/15

↑ 1370mm ↔ 840mm  
→ ∅  
QT14, G9, 4 x 33W  
↗ 98212/15



4 004353 238956

## 2. 17675/15

↑ 1415mm ↔  
→ ∅ 320mm  
QT14, G9, 5 x 33W  
↗ 98212/15



4 004353 249594

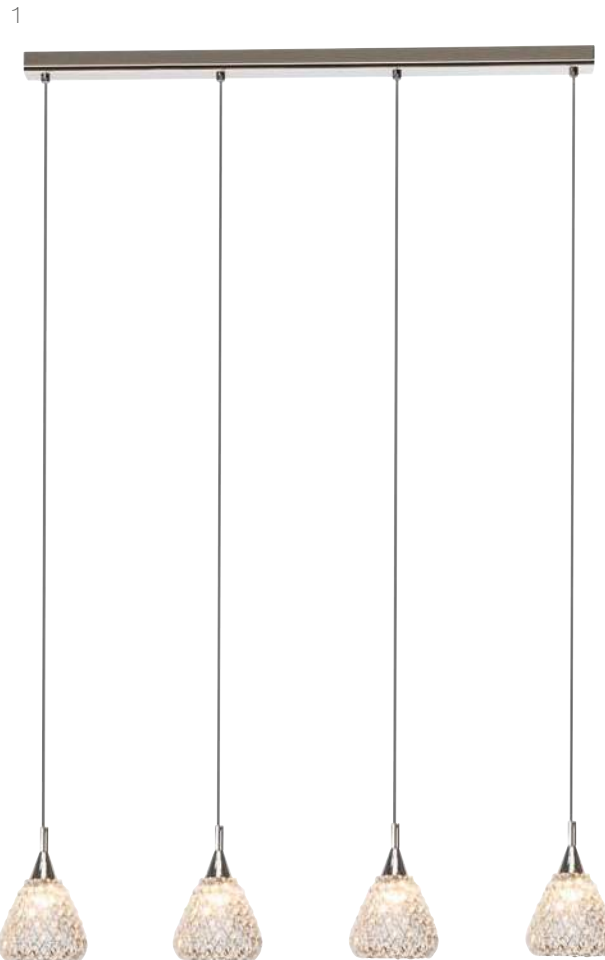



1-3

## Vegas

chrome  
metal/plastic

### 1. 17695/15

↑ 160mm ↔  
→ ø 520mm  
QT14, G9, 5 x 33W  
↗ 98212/15



1



### 2. 17693/15

↑ 155mm ↔  
→ ø 410mm  
QT14, G9, 3 x 33W  
↗ 98212/15



2



### 3. 17690/15

↑ 500mm ↔ 130mm  
→ 260mm ø  
QT14, G9, 1 x 33W  
↗ 98212/15



3







1 - 4

## Noble

chrome  
metal/glass

### 1. 29210/15

↑ 120mm ↔ 120mm  
→ 130mm ∅  
QT14, G9, 1 x 28W  
↗98302/00



### 2. 29230/15

↑ 130mm ↔ 520mm  
→ 110mm ∅  
QT14, G9, 3 x 28W  
↗98302/00



### 3. 29235/15

↑ 130mm ↔ 20mm  
→ 420mm ∅  
QT14, G9, 4 x 28W  
↗98302/00



### 4. 94435/15

↑ 150mm ↔ 80mm  
→ 640mm ∅  
QT14, G9, 6 x 28W  
↗98302/00



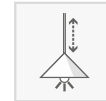

# Noble

chrome  
metal/glass

1.94436/15 

↑ 1420mm ↔  
→ ø 790mm  
QT14, G9, 12 x 28W  
/98302/00





1-2



2

# Dubai

chrome  
metal/plastic

1. 93585/15

‡ 220mm ↔  
→ † 460mm  
QT14, G9, 6 x 33W  
↗ 98153/00



4 004353 239434

2. 93532/15

‡ 1400mm ↔  
→ † 430mm  
QT14, G9, 6 x 33W  
↗ 98153/00



4 004353 212857

1



2





1



1



2

## Dubai

chrome  
metal/plastic

1.93627/15

↑ 1340mm ↔ 220mm  
→ 940mm ∅  
QT14, G9, 3 x 42W  
/98293/00



4 004353 249983

1

2.93628/15

↑ 540mm ↔  
→ ∅ 300mm  
QT14, G9, 4 x 42W  
/98294/00



4 004353 249990

2





1-2



1

## Date

chrome  
metal/glass

### 1. 26973/15

‡ 1350mm ↔  
→ ø 320mm  
QT14, G9, 3 x 33W  
↗ 98283/00, 98285/00



4 004353 249310

### 2. 26995/15

‡ 130mm ↔  
→ ø 540mm  
QT14, G9, 5 x 33W  
↗ 98284/00, 98286/00



4 004353 249204





1-3



1-2

## Date

chrome  
metal/glass

### 1. 26970/15

↑ 1320mm ↔  
→ ø 100mm  
QT14, G9, 1 x 33W  
↗ 98283/00, 98285/00



### 2. 26974/15

↑ 1320mm ↔790mm  
→ 100mm ø  
QT14, G9, 4 x 33W  
↗ 98283/00, 98285/00



### 3. 26910/15

↑ 120mm ↔120mm  
→ ø 130mm  
QT14, G9, 1 x 42W  
↗ 98284/00, 98286/00

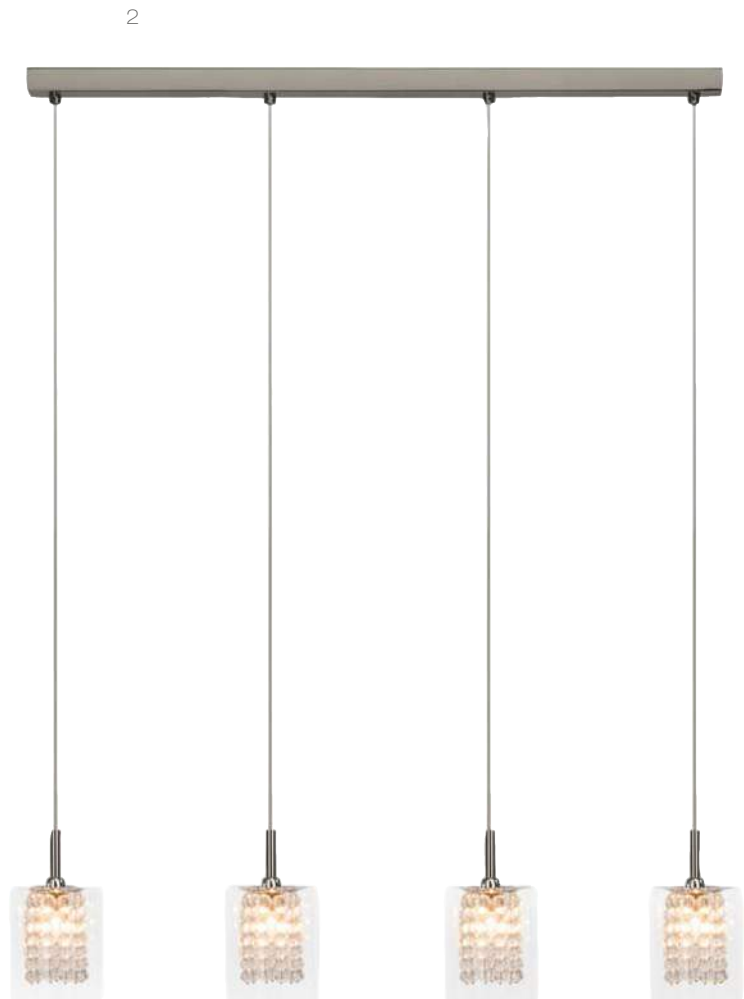



1

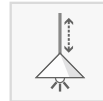

1



2

## Bulb

chrome/transparent  
metal/glass

**1.93429/15** ☹

‡ 1300mm ↔  
→ ø 270mm  
A60, E27, 1 x 60W  
♣98378/00



4 004353 182907

**2.21258/15**

‡ 1530mm ↔  
→ ø 295mm  
A60, E27, 1 x 60W  
♣98378/00



4 004353 254642

1



2



SEE OTHER VERSIONS  
ON PAGE  
**78**

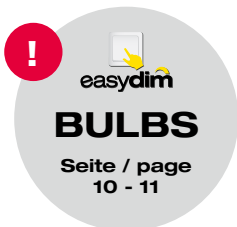

**BULBS**  
Seite / page  
10 - 11





2



1



2

## Bulby

chrome/transparent  
metal/glass

### 1. 17347/15

‡ 290mm ↔  
→ ø 150mm  
A60, E27, 1 x 42W



4 004353 174377

### 2. 17370/15

‡ 1200mm ↔  
→ ø 150mm  
A60, E27, 1 x 42W



4 004353 174384

1



2





1-3



1-2

## Eode

chrome  
metal/glass

### 1. 38998/15

↑ 490mm ↔ 830mm  
→ 140mm ∅  
QT14, G9, 8 x 33W  
↗ 98370/15



4 004353 254680

### 2. 38994/15

↑ 320mm ↔ 660mm  
→ 140mm ∅  
QT14, G9, 4 x 33W  
↗ 98370/15



4 004353 254673

### 3. 38992/15

↑ 250mm ↔ 180mm  
→ 105mm ∅  
QT14, G9, 2 x 33W  
↗ 98370/15



4 004353 254697





1



2

## Eode

chrome  
metal/glass

### 1. 38959/15

↑ 1600mm ↔  
→ ∅ 220mm  
QT14, G9, 3 x 33W  
↗ 98370/15



4 004353 254710

### 2. 38942/15

↑ 400mm ↔ 250mm  
→ ∅  
QT14, G9, 2 x 33W  
↗ 98370/15



4 004353 254703

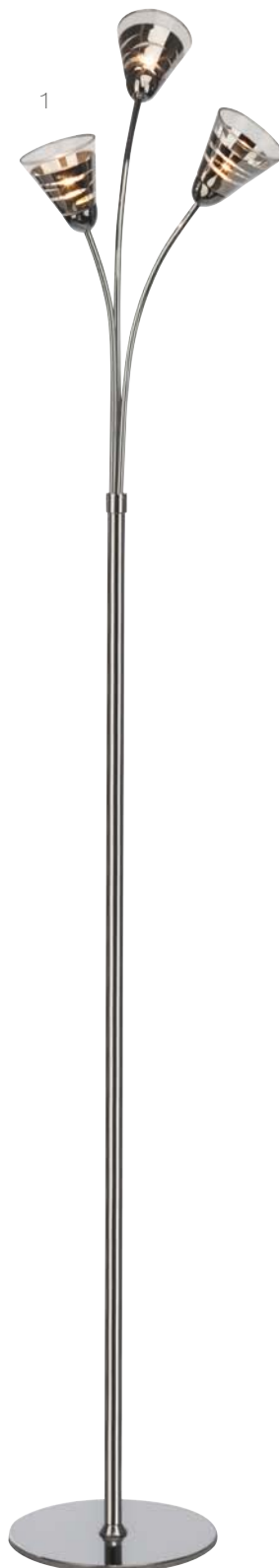

**LED**  
incl.

1-3

## Cinta

chrome  
metal/glass

### 1. G22693/15

↑ 170mm ↔ 720mm  
→ 380mm ∅  
LED, G9, 3 x 3,5W   
3 x 320 lm, 3000 K, **A+**  
↗ 98257/00



### 2. G22694/15

↑ 135mm ↔ 600mm  
→ 380mm ∅  
LED, G9, 4 x 3,5W   
4 x 320 lm, 3000 K, **A+**  
↗ 98257/00



### 3. G22695/15

↑ 175mm ↔ 850mm  
→ 740mm ∅  
LED, G9, 5 x 3,5W   
5 x 320 lm, 3000 K, **A+**  
↗ 98257/00



SEE OTHER VERSIONS  
ON PAGE  
**76**

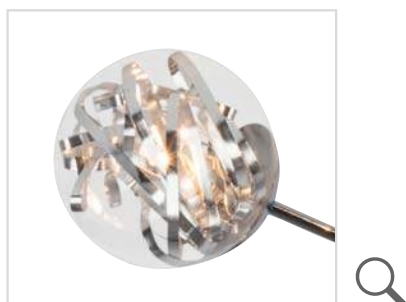



1-3



4



1

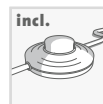

2



4

## Cinta

chrome  
metal/glass

### 1. G22642/15

↑ 430mm ↔  
→ ø 140mm  
LED, G9, 2 x 3,5W   
2 x 320 lm, 3000 K, **A+**  
↗98257/00



4 004353 246104

### 2. G22659/15

↑ 1400mm ↔  
→ ø 265mm  
LED, G9, 3 x 3,5W   
3 x 320 lm, 3000 K, **A+**  
↗98257/00



4 004353 246111

### 3. G22692/15

↑ 330mm ↔290mm  
→135mm ø  
LED, G9, 2 x 3,5W   
2 x 320 lm, 3000 K, **A+**  
↗98257/00



4 004353 246128

### 4. 22670/15

↑ 1380mm ↔  
→ ø 300mm  
A60, E27, 1 x 60W  
↗98258/00



4 004353 246135



640  
LUMEN

960  
LUMEN

640  
LUMEN



1-2



3



4

## Joya

chrome  
metal/glass

**1. 00299/15** ☹

↑ 1350mm ↔  
→ ∅ 700mm  
QT14, G9, 9 x 33W  
↗ 98099/15



4 004353 216046

**2. 00293/15** ☹

↑ 400mm ↔ 260mm  
→ 120mm ∅  
QT14, G9, 3 x 33W  
↗ 98099/15



4 004353 245312

**3. 94854/15** ☐

↑ 430mm ↔  
→ 100mm ∅ 200mm  
QT14, G9, 2 x 33W  
↗ 98099/15



4 004353 215865

**4. 94855/15** ☐

↑ 1410mm ↔  
→ 200mm ∅ 400mm  
QT14, G9, 3 x 33W  
↗ 98099/15



4 004353 215872

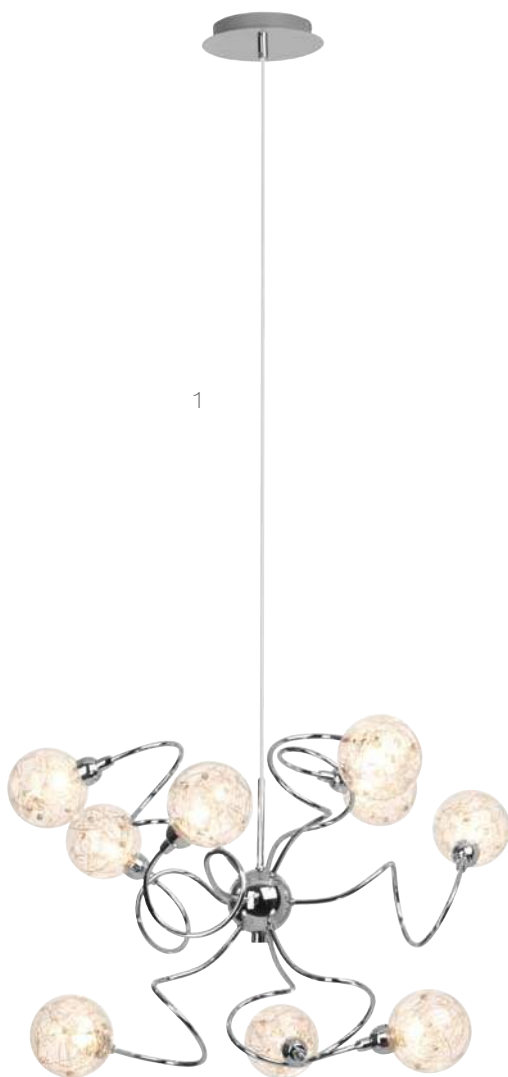

1



2

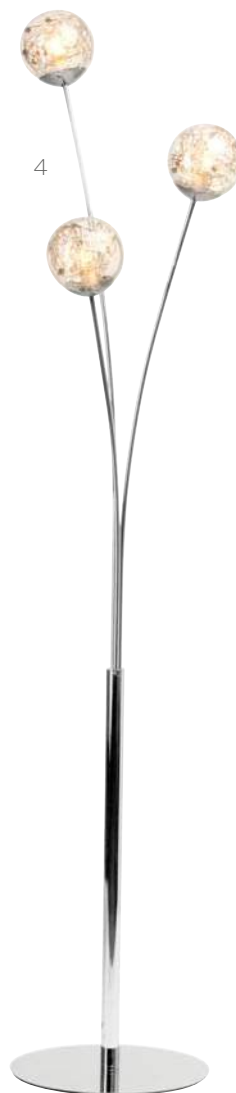

4

3

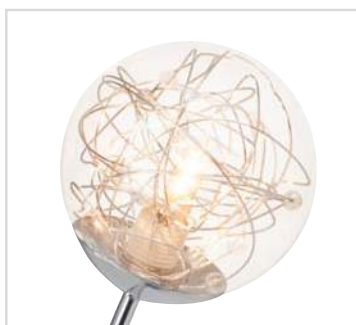



1-4



1-2,4

## Joya

chrome  
metal/glass

### 1.00206/15

↑ 280mm ↔ 960mm  
→ 460mm ∅  
QT14, G9, 6 x 33W  
↗98099/15



4 004353 216084



1

### 2.00213/15

↑ 140mm ↔ 360mm  
→ 220mm ∅  
QT4, G9, 2 x 33W  
↗98099/15



4 004353 216060



2

### 3.00233/15

↑ 265mm ↔ 400mm  
→ ∅  
QT14, G9, 3 x 33W  
↗98099/15



4 004353 216077



3

### 4.00210/15

↑ 120mm ↔  
→ 190mm ∅ 100mm  
QT14, G9, 1 x 33W  
↗98099/15



4 004353 216053



4



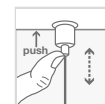

## Maira

chrome/transparent  
metal/glass

### 1. G14776/15

↓ 1450mm ↔  
→ ø330mm  
QT-LP9, G4, 3 x 20W ☑  
3 x 255 lm, 2800 K  
↗ 92575/00, 99922/00



### 2. G14773/15

↓ 1450mm ↔  
→ ø410mm  
QT-LP9, G4, 5 x 20W ☑  
5 x 255 lm, 2800 K  
↗ 92575/00, 99922/00



### 3. G14772/15

↓ 1250mm ↔750mm  
→ 120mm ø  
QT-LP9, G4, 4 x 20W ☑  
4 x 255 lm, 2800 K  
↗ 92575/00, 99922/00

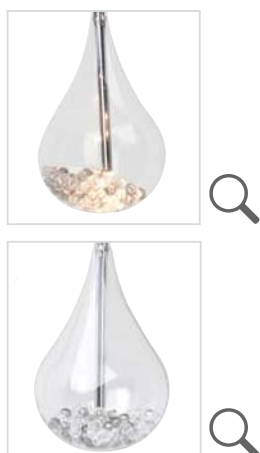



## Maira

chrome/transparent  
metal/glass

1.G14710/15 

‡ 510mm ↔ 110mm  
→ 250mm ø  
QT-LP9, G4, 1 x 20W   
1 x 255 lm, 2800 K  
↗ 92575/00





1-3

# Fonda

chrome  
metal/glass

## 1. 22595/15

↑ 140mm ↔  
→ ø 450mm  
QT14, G9, 5 x 33W  
↗98229/98



## 2. 22534/15

↑ 140mm ↔  
→ ø 300mm  
QT14, G9, 3 x 33W  
↗98229/98



## 3. 22510/15

↑ 130mm ↔  
→160mm ø 90mm  
QT14, G9, 1 x 33W  
↗98229/98





1



1



2



3

## Fonda

chrome  
metal/glass

### 1. 22574/15 ☹

‡ 1100mm ↔ 800mm  
→ ∅  
QT14, G9, 4 x 33W  
♣98229/98



4 004353 243387

### 2. 22559/15 ☐

‡ 1620mm ↔  
→ ∅ 250mm  
QT14, G9, 3 x 33W  
♣98229/98



4 004353 243400

### 3. 22548/15 ☐

‡ 410mm ↔  
→ ∅ 130mm  
QT14, G9, 1 x 33W  
♣98229/98



4 004353 243417





1, 3



2



4

## Virgo

chrome  
metal

### 1. G02235/15 ☉

↑ 135mm ↔ 640mm  
→ 400mm ø  
QT14, G9, 4 x 33W ☑  
4 x 458 lm, 2800 K  
↗98012/15



4 004353 173820

### 2. G02259/15 ☐

↑ 1590mm ↔  
→ 400mm ø 200mm  
QT14, G9, 3 x 33W ☑  
3 x 458 lm, 2800 K  
↗98012/15



4 004353 173868

### 3. G02292/15 ☉

↑ 250mm ↔ 250mm  
→ 160mm ø  
QT14, G9, 2 x 33W ☑  
2 x 458 lm, 2800 K  
↗98012/15



4 004353 173882

### 4. G02242/15 ☐

↑ 370mm ↔  
→ 150mm ø  
QT14, G9, 2 x 33W ☑  
2 x 458 lm, 2800 K  
↗98012/15



4 004353 173844

SEE OTHER VERSIONS  
ON PAGE  
**93**





1-2

# Virgo

chrome  
metal

## 1. G02295/15

↑ 590mm ↔  
→ ø 600mm  
QT14, G9, 5 x 33W   
5 x 458 lm, 2800 K  
↗ 98012/15



## 2. G02299/15

↑ ↔  
→ 210mm ø 780mm  
QT14, G9, 9 x 33W   
9 x 458 lm, 2800 K  
↗ 98012/15



2

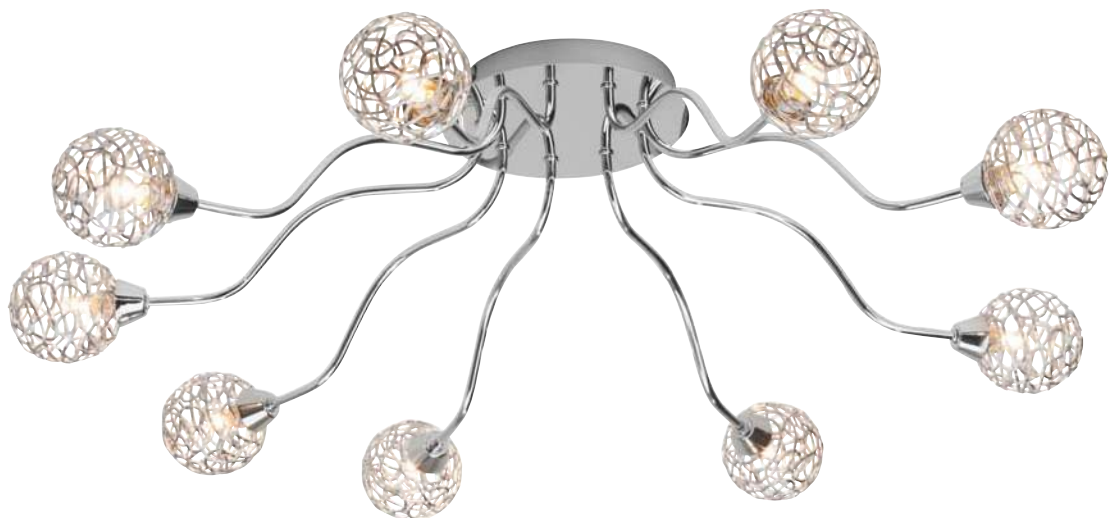



1-3



1-3

## Status

white  
plastic/metal

### 1. 60875/05

‡ 1500mm ↔  
→ ø 410mm  
A60, E27, 5 x 28W  
↗ 98121/05, 98122/05,  
98245/05



4 004353 212710

### 2. 60873/05

‡ 1500mm ↔  
→ ø 310mm  
A60, E27, 1 x 60W  
↗ 98121/05, 98122/05,  
98241/05



4 004353 205620

### 3. 60877/05

‡ 1500mm ↔  
→ ø 500mm  
A60, E27, 6 x 25W  
↗ 98123/05, 98124/05,  
98247/05



4 004353 205637

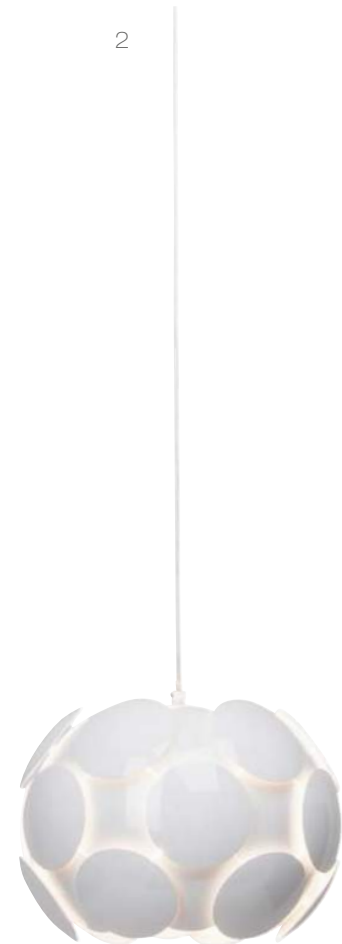

3







1 - 4

## Status

white  
plastic/metal

### 1. 60898/05

↑ 200mm ↔  
→ 820mm  
A60, E27, 8 x 25W  
↗ 98123/05, 98124/05,  
98248/05



4 004353 239540



### 2. 60880/05

↑ 270mm ↔  
→ 270mm ø 620mm  
A60, E27, 7 x 25W  
↗ 98123/05, 98124/05,  
98240/05



4 004353 205613

2



### 3. 60895/05

↑ 240mm ↔  
→ 240mm ø 410mm  
A60, E27, 5 x 25W  
↗ 98121/05, 98122/05,  
98239/05



4 004353 205606

3



### 4. 60890/05

↑ 260mm ↔ 260mm  
→ 135mm ø  
A60, E27, 1 x 60W  
↗ 98121/05, 98122/05,  
98243/05



4 004353 205651

4





1-2

## Status

white  
plastic/metal

### 1. 60848/05

↑ 480mm ↔  
→ ø 310mm  
A60, E27, 1 x 60W  
✓ 98121/05, 98122/05,  
98242/05



4 004353 205644

### 2. 60847/05

↑ 350mm ↔  
→ ø 200mm  
A60, E27, 1 x 60W  
✓ 98121/05, 98122/05,  
98246/05,



4 004353 212727

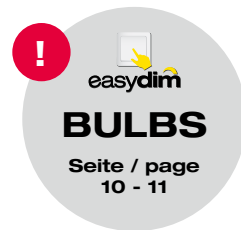



# Status

white  
plastic/metal

1.60858/05 

↑ 1705mm ↔  
→ ø 285mm  
D45, E14, 9 x 25W  
✓ 98121/05, 98122/05,  
98244/05





1-3



3

## Ship

white  
metal

### 1. 59593/05

↑ 165mm ↔ 980mm  
→ 245mm ∅  
A60, E27, 3 x 25W  
↗ 98236/05



1



### 2. 59592/05

↑ 130mm ↔ 600mm  
→ 140mm ∅  
D45, E14, 2 x 40W  
↗ 98235/05



2



### 3. 59576/05

↑ 1300mm ↔ 980mm  
→ 245mm ∅  
A60, E27, 3 x 25W  
↗ 98233/05



3





1-3

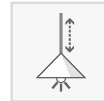

1



4

## Ship

white  
metal/plastic

### 1. 59569/05

↑ 1400mm ↔  
→ 480mm  
C35, E14, 6 x 25W  
↗98231/05



4 004353 216732

### 2. 59591/05

↑ 210mm ↔  
→ 210mm ø 480mm  
C35, E14, 6 x 25W  
↗98231/05



4 004353 205590

### 3. 59590/05

↑ 305mm ↔ 245mm  
→ 125mm ø  
C35, E14, 1 x 40W



4 004353 205583

### 4. 59548/05

↑ 460mm ↔  
→ 240mm ø  
A60, E27, 1 x 60W  
↗98237/05



4 004353 212697

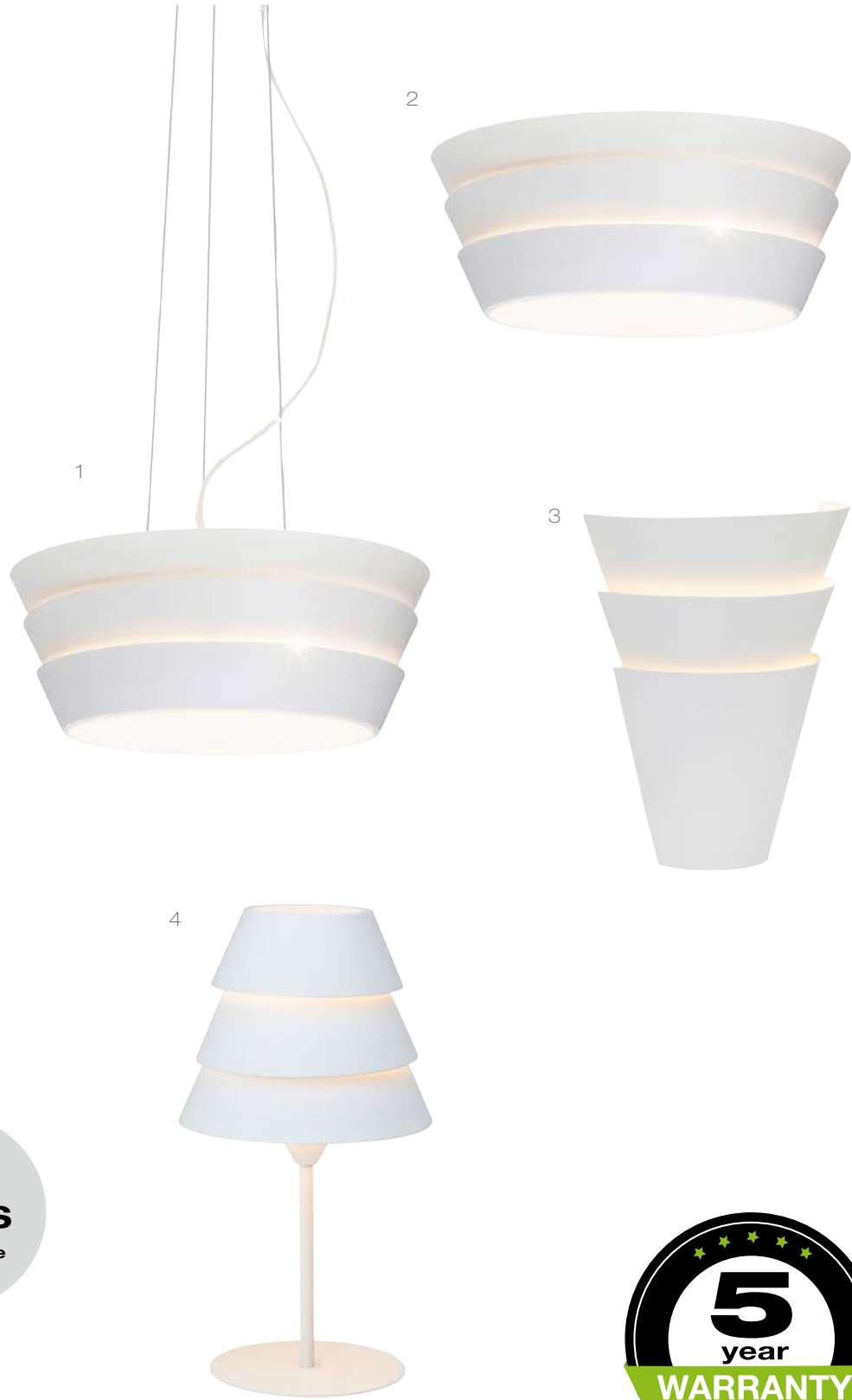



1-3

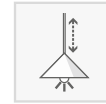

2

## Ship

white/gold  
metal/plastic

### 1. 59594/30

↓ 170mm ↔ 1200mm  
→ 250mm ∅  
A60, E27, 4 x 28W  
↗ 98238/05



1



### 2. 59574/30

↓ 1200mm ↔ 1200mm  
→ 250mm ∅  
A60, E27, 4 x 28W  
↗ 98232/05



2



### 3. 59590/30

↓ 305mm ↔ 245mm  
→ 125mm ∅  
C35, E14, 1 x 40W



3





1-2



2



3

## Ship

white/gold  
metal/plastic

### 1. 59596/30

↓ 200mm ↔  
→ ø 585mm  
A60, E27, 6 x 28W  
#98234/05



### 2. 59569/30

↓ 1400mm ↔  
→ ø 480mm  
C35, E14, 6 x 25W  
#98231/05



### 3. 59548/30

↓ 460mm ↔  
→ ø 240mm  
A60, E27, 1 x 60W  
#98237/05

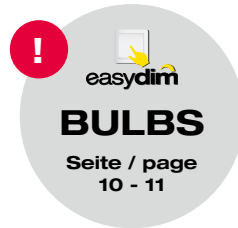

2







1 - 4

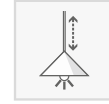

1, 3

# Crush

chrome/white/gold  
metal/glass

**1. 94467/15** ⊕

↓ 1482mm ↔  
→ ø 400mm  
A60, E27, 1 x 40W



4 004353 249280

1



**2. 94466/15** ⊕

↓ 240mm ↔  
→ ø 400mm  
A60, E27, 1 x 40W



4 004353 249150

2



**3. 94467/85** ⊕

↓ 1482mm ↔  
→ ø 400mm  
A60, E27, 1 x 40W



4 004353 249297



3

**4. 94466/85** ⊕

↓ 240mm ↔  
→ ø 400mm  
A60, E27, 1 x 40W



4 004353 249273

4





1-4



1-2

# Aztekas

white/gold/silver  
metal

## 1. 24970/85

‡ 1500mm ↔  
→ ø 344mm  
A60, E27, 1 x 40W



4 004353 247729



1

## 2. 24970/75

‡ 1500mm ↔  
→ ø 344mm  
A60, E27, 1 x 40W



4 004353 247705



2

## 3. 24991/75

‡ 185mm ↔  
→ ø 344mm  
A60, E27, 1 x 40W



4 004353 247682



3

SEE OTHER VERSIONS  
ON PAGE  
**106 - 107**

## 4. 24991/85

‡ 185mm ↔  
→ ø 344mm  
A60, E27, 1 x 40W



4 004353 247699



4

easydim  
**BULBS**  
Seite / page  
10 - 11

**5**  
year  
**WARRANTY**  
BRILLIANT



1-2



1

# Vulcano

white matt  
metal

1.94434/05 

↑ 1420mm ↔  
→ ø 550mm  
QT14, G9, 4 x 33W



4 004353 239380

2.94433/05 

↑ 195mm ↔  
→ ø 550mm  
QT14, G9, 4 x 33W



4 004353 239373

2



1





1-2



1

# Vulcano

white/gold  
metal

1.94434/65 

‡ 1420mm ↔  
→ ø 550mm  
QT14, G9, 4 x 33W



4 004353 249662

2.94433/65 

‡ 195mm ↔  
→ ø 550mm  
QT14, G9, 4 x 33W



4 004353 249655

2



1





1-2

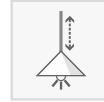

1-2



3-4

## Icedrop

white  
glass/metal

### 1. 93632/15

‡ 1500mm ↔  
→ ø 280mm  
A60, E27, 1 x 26W  
98395/05



4 004353 250033

### 2. 93582/15

‡ 1450mm ↔  
→ ø 200mm  
A60, E27, 1 x 30W  
98213/05



4 004353 239342

### 3. 93634/05

‡ 410mm ↔  
→ ø 200mm  
A60, E27, 1 x 26W



4 004353 250040

### 4. 93633/05

‡ 320mm ↔  
→ ø 160mm  
A60, E27, 1 x 26W



4 004353 250057

1



2



3



4





## Icedrop

satin nickel/white  
glass/metal

1.93583/15 

↑ 1650mm ↔  
→ ∅ 200mm  
A60, E27, 2 x 30W  
↗ 98213/05

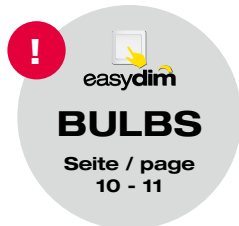
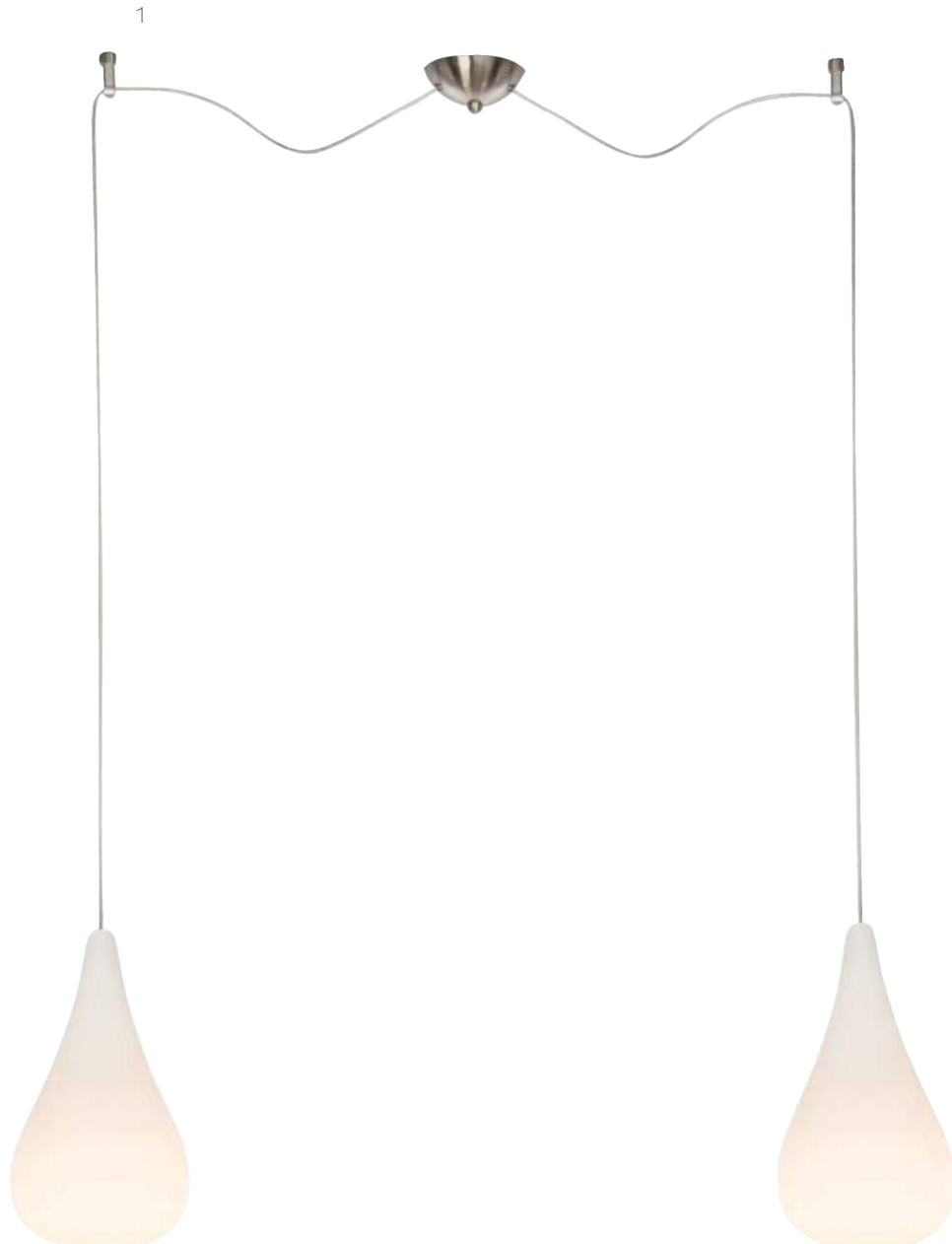



1-3



1



2

## Mailand

white  
metal/glass

### 1. 93514/05

‡ 2000mm ↔  
→ ø 300mm  
A60, E27, 2 x 60W  
♣98125/05



4 004353 205484

### 2. 93513/05

‡ 1800mm ↔  
→ ø 300mm  
A60, E27, 1 x 60W  
♣98125/05



4 004353 205491

### 3. 93512/05

‡ 205mm ↔  
→ ø 300mm  
A60, E27, 1 x 60W  
♣98125/05



4 004353 205507





DECORATIVE





1-3



1-3

## Boston

satin nickel/white alabaster  
metal/glass

### 1. 12870/13

‡ 1000mm ↔  
→ ø 320mm  
A60, E27, 1 x 60W  
↗ 98019/94



4 004353 174315

### 2. 12876/13

‡ 620 - 820mm ↔ 750mm  
→ 200mm ø  
D45, E14, 3 x 40W  
↗ 98018/94



4 004353 174322

### 3. 12871/13

‡ 620 - 820mm ↔ 690mm  
→ 200mm ø  
D45, E14, 2 x 40W  
↗ 98018/94



4 004353 175176



1620 - 820mm



1620 - 820mm



## Boston

satin nickel/white alabaster  
metal/glass

### 1. 12848/13

↑ 450mm ↔  
→ ø 320mm  
D45, E14, 2 x 40W  
↗ 98020/94



### 2. 12858/13

↑ 1370mm ↔  
→ ø 320mm  
D45, E14, 2 x 40W  
↗ 98020/94

**easydim**  
**BULBS**  
Seite / page  
10 - 11



1-2



1



3



4

## Shoot

satin nickel/white  
metal/glass

### 1. 93599/13

↑ 1280mm ↔  
→ ∅ 630mm  
QT14, G9, 9 x 33W  
↗ 98226/05



4 004353 243301

### 2. 93667/13

↑ 260mm ↔ 285mm  
→ 150mm ∅  
QT14, G9, 3 x 33W  
↗ 98226/05



4 004353 254611

### 3. 93665/13

↑ 365mm ↔ 310mm  
→ ∅  
QT14, G9, 3 x 33W  
↗ 98226/05



4 004353 254628

### 4. 93666/13

↑ 1585mm ↔ 540mm  
→ ∅  
QT14, G9, 6 x 33W  
↗ 98226/05



4 004353 254635



SEE OTHER COLOUR  
ON PAGE  
**244 - 245**



1-3



1,3



4

## Bona

white  
metal/glass

### 1. 10570/05

↓ 1560mm ↔  
→ ø250mm  
A60, E27, 1 x 60W  
92460/05



4 004353 106705

### 2. 10599/05

↓ 115mm ↔  
→ ø380mm  
C35, E14, 3 x 40W



4 004353 106712

### 3. 10578/05

↓ 750 - 1400mm ↔  
→ ø400mm  
A60, E27, 1 x 60W  
92461/05



4 004353 107566

### 4. 10548/05

↓ ↔  
→ ø250mm  
A60, E27, 1 x 60W



4 004353 106699



1



2



4

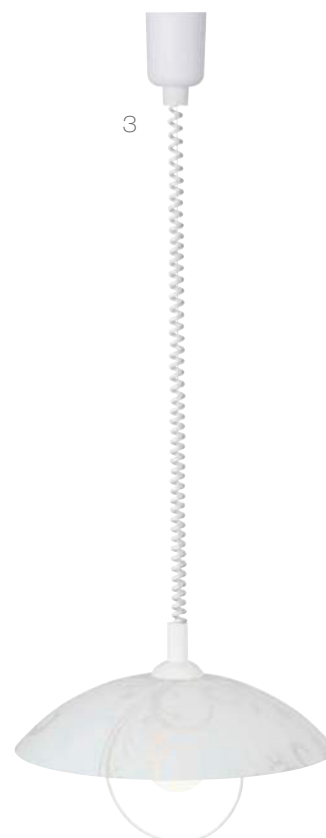

3

SEE OTHER VERSIONS  
ON PAGE  
**84**



1 - 4

# Timo

satin nickel/white alabaster/white pattern/red-orange-alabaster  
glass/metal/plastic

**1.51870/94**

↓ 1500mm ↔  
→ ∅ 200mm  
A60, E27, 1 x 60W



4 004353 160363

**2.51870/75**

↓ 1500mm ↔  
→ ∅ 200mm  
A60, E27, 1 x 60W



4 004353 160356

**3.51890/94**

↓ 1600mm ↔  
→ ∅ 300mm  
A60, E27, 1 x 60W



4 004353 160387

**4.51890/24**

↓ 1600mm ↔  
→ ∅ 300mm  
A60, E27, 1 x 60W



4 004353 160370

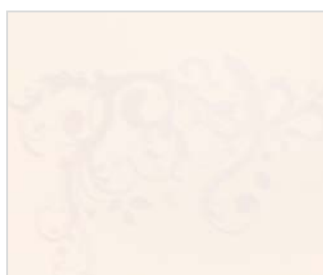

2



**BULBS**  
Seite / page  
10 - 11



1 - 6

## Timo

white/red-orange-alabaster/  
white pattern/white alabaster  
glass/plastic

**1. 51847/05** 

↑                    ↔  
→                    ø 200mm  
A60, E27, 1 x 60W



4 004353 160295



**2. 51847/24** 

↑                    ↔  
→                    ø 200mm  
A60, E27, 1 x 60W



4 004353 160301



**3. 51847/75** 

↑                    ↔  
→                    ø 200mm  
A60, E27, 1 x 60W



4 004353 160318



**4. 51848/05** 

↑                    ↔  
→                    ø 250mm  
A60, E27, 1 x 60W



4 004353 160332

**5. 51847/94** 

↑                    ↔  
→                    ø 200mm  
A60, E27, 1 x 60W



4 004353 160325

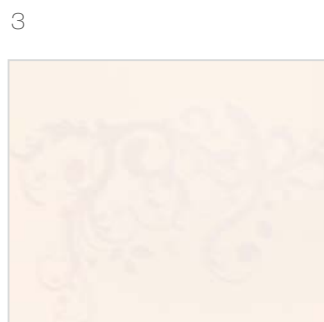

**6. 51848/94** 

↑                    ↔  
→                    ø 250mm  
A60, E27, 1 x 60W



4 004353 160349







1-2



3



3

# Independent

grey/black  
metal/glass/textile

## 1. 93635/22

↑ 240mm ↔  
→ ø 500mm  
A60, E27, 3 x 60W  
↗ 323191-22



## 2. 93636/22

↑ 230mm ↔ 180mm  
→ ø  
A60, E27, 1 x 60W



## 3. 93637/22

↑ 650mm ↔ 100mm  
→ 250mm ø  
A60, E27, 1 x 60W





2

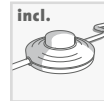

1

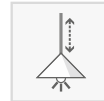

2



1-2

# Independent

grey/black  
metal/textile

**1. 93564/22** □

‡ 1660 - 2335mm ↔310mm  
→ 650mm ø  
A60, E27, 1 x 60W



4 004353 229183

**2. 93563/22** ⊕

‡ 1100mm ↔  
→ ø 260mm  
A60, E27, 1 x 60W



4 004353 229176

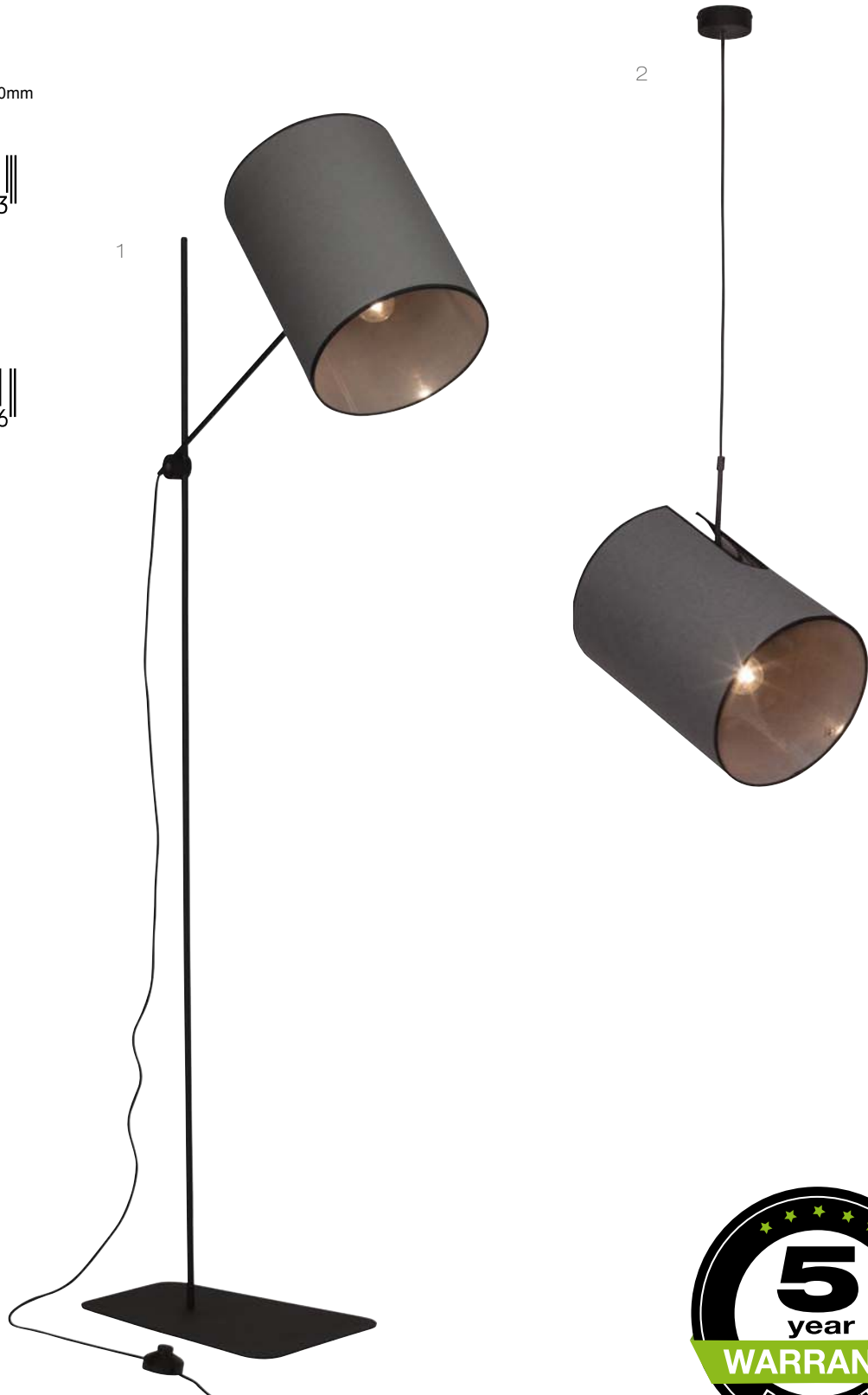



1

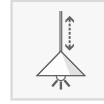

1

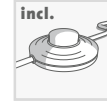

2

# Giraffe

anthracite  
metal/textile

1. 94869/63

↑ 860mm ↔  
→ ø 460mm  
A60, E27, 3 x 60W



4 004353 250521

2. 94868/63

↑ 2200mm ↔  
→ 1800mm ø 460mm  
A60, E27, 3 x 60W



4 004353 250545



**!** **easydim**  
**BULBS**  
Seite / page  
10 - 11

**5**  
year  
**WARRANTY**  
BRILLIANT



1



1



2

# Giraffe

black/gold  
metal/textile

**1. 94869/86** ⊕

↑ 860mm ↔  
→ ø 460mm  
A60, E27, 3 x 60W



4 004353 218545

**2. 94868/86** ⊕

↑ 2200mm ↔  
→ 1800mm ø 460mm  
A60, E27, 3 x 60W



4 004353 218538





1-2



1



3



4

## Clarie

satin nickel/white  
metal/textile

**1. 93374/05** ☹

↑ 1000mm ↔  
→ ∅ 400mm  
A60, E27, 1 x 60W



4 004353 149450

**2. 13291/05** ☐

↑ 320mm ↔  
→ ∅ 400mm  
A60, E27, 1 x 60W



4 004353 158674

**3. 13258/05** ☐

↑ 1800mm ↔  
→ 1130mm ∅ 360mm  
A60, E27, 1 x 60W



4 004353 158650

**4. 13247/05** ☐

↑ 255mm ↔  
→ ∅ 120mm  
D45, E14, 1 x 40W



4 004353 175190





1-2

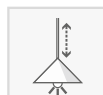

1



3



4

## Clarie

satin nickel/grey  
metal/textile

### 1. 93374/22

↓ 1000mm ↔  
→ ø400mm  
A60, E27, 1 x 60W



4 004353 149474

### 2. 13291/22

↓ 320mm ↔  
→ ø400mm  
A60, E27, 1 x 60W



4 004353 158681

### 3. 13258/22

↓ 1800mm ↔  
→ 1130mm ø360mm  
A60, E27, 1 x 60W



4 004353 158667

### 4. 13247/22

↓ 255mm ↔  
→ ø120mm  
D45, E14, 1 x 40W



4 004353 175213





1-2



1



3

## Clarie

satin nickel/black  
metal/textile

**1. 93374/06** ☹

↑ 1000mm ↔  
→ ø400mm  
A60, E27, 1 x 60W



4 004353 149467

**2. 13291/06** ☐

↑ 320mm ↔  
→ ø400mm  
A60, E27, 1 x 60W



4 004353 175237

**3. 13247/06** ☐

↑ 255mm ↔  
→ ø120mm  
D45, E14, 1 x 40W



4 004353 175206





DECORATIVE





1-3



1-2

## Fiore

bronze antique/brown alabaster  
metal/glass

### 1.81970/58

↑ 1360mm ↔  
→ ø400mm  
A60, E27, 1 x 100W  
↗ 91693/20



4 004353 053542

### 2.81971/58

↑ 1420mm ↔770mm  
→ ø  
A60, E27, 2 x 75W  
↗ 91695/20



4 004353 053559

### 3.81910/58

↑ 400mm ↔  
→240mm ø  
A60, E27, 1 x 75W  
↗ 91694/20



4 004353 053511



1



2



3



## Fiore

bronze antique/brown alabaster  
metal/glass

1.81949/58 

↑ 450mm ↔

→ ø320mm

A60, E27, 1 x 75W

↗ 91695/20





1-2



1-2



3

## Amira

brown/white alabaster  
metal/glass

### 1. 77371/20

↑ 850 - 1750mm ↔ 470mm  
→ 175mm ø  
D45, E14, 2 x 40W  
♣92561/94



4 004353 174407

### 2. 77379/20

↑ 850 - 1750mm ↔  
→ ø 170mm  
D45, E14, 1 x 40W  
♣92561/94



4 004353 174414

### 3. 77347/20

↑ 350mm ↔  
→ ø175mm  
D45, E14, 1 x 40W  
♣92561/94



4 004353 174391

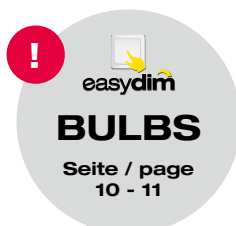
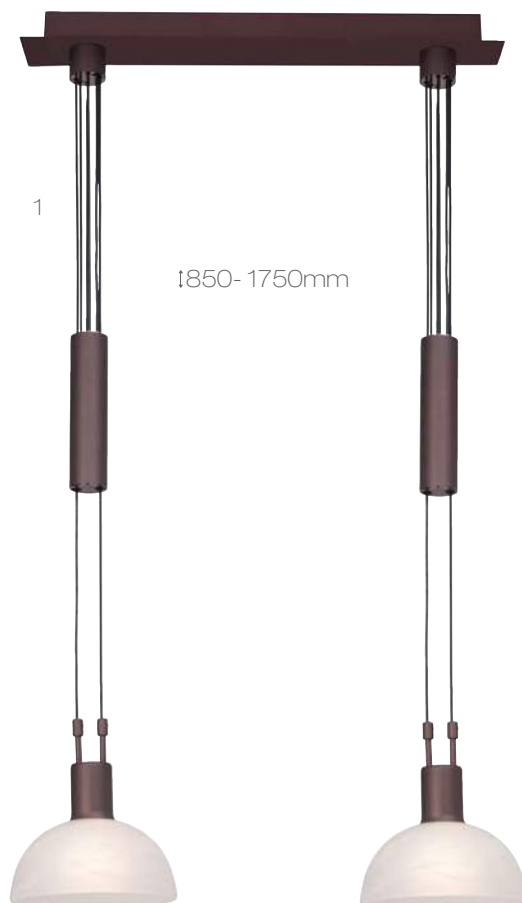



1,3



1



2

## Elena

black/white alabaster  
metal/glass

**1.66773/76** □

↑ 900mm ↔  
→ ø 560mm  
D45, E14, 5 x 40W  
↗92466/94



**2.66747/76** □

↑ 320mm ↔  
→ ø 190mm  
D45, E14, 1 x 40W  
↗92466/94



**3.66792/76** ⊕

↑ 320mm ↔ 410mm  
→ 200mm ø  
D45, E14, 2 x 40W  
↗92464/94



1



2



3





1-2



2

# Billy

black/copper  
metal

1.94447/76 ☹

↑ 170mm ↔  
→ 290mm ø 230mm  
C35, E14, 1 x 40W



2.93677/76

↑ 1120mm ↔  
→ ø 350mm  
A60, E27, 1 x 60W





## Synergy

black/copper  
metal

1. 93592/29 ☹

‡ 1430mm ↔  
→ ø 260mm  
A60, E27, 1 x 60W



2. 93593/76 ☐

‡ 185mm ↔  
→ ø 220mm  
A60, E27, 1 x 60W



1



1



2

**!** LED  
FILAMENT  
BULBS  
Seite / page  
326





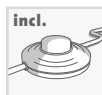

1

1

2

3

1-3

## Dalma

black/copper  
metal

### 1. 21074/76

↓ 1330mm ↔ 755mm  
→ ∅  
QT14, G9, 4 x 33W



4 004353 240386

### 2. 21059/76

↓ 1655mm ↔  
→ ∅ 220mm  
QT14, G9, 3 x 33W



4 004353 252280

### 3. 21048/76

↓ 405mm ↔  
→ 145mm ∅ 130mm  
QT14, G9, 1 x 33W



4 004353 240379



SEE OTHER VERSIONS  
ON PAGE  
**112 - 113**



# Dalma

black/copper  
metal

1.93478/29 ☺

‡ 1400mm ↔  
→ ø 300mm  
A60, E27, 1 x 42W



4 004353 199134



**!**  
**LED  
FILAMENT  
BULBS**  
Seite / page  
326



1-2



1-2

## Shoot

black/white  
metal/glass

**1. 93599/06** Ⓣ

‡ 1280mm ↔  
→ ø 630mm  
QT14, G9, 9 x 33W  
↗ 98226/05



**2. 93664/06** Ⓣ

‡ 1310mm ↔  
→ ø 660mm  
QT14, G9, 13 x 33W  
↗ 98226/05





1



2



3

## Shoot

black/white  
metal/glass

### 1. 93667/06

↑ 260mm ↔ 285mm  
→ 150mm ∅  
QT14, G9, 3 x 33W  
↗98226/05



4 004353 252914

### 2. 93665/06

↑ 365mm ↔  
→ ∅ 310mm  
QT14, G9, 3 x 33W  
↗98226/05



4 004353 252310

### 3. 93666/06

↑ 1585mm ↔  
→ ∅ 540mm  
QT14, G9, 6 x 33W  
↗98226/05



4 004353 252358



SEE OTHER COLOUR  
ON PAGE  
**224**



1-2



1-2



3-4

## Route 66

black/copper/satin nickel/chrome metal

### 1. 94863/76

‡ 890mm ↔  
→ ø 270mm  
D45, E14, 1 x 40W



4 004353 217371

### 2. 94863/77

‡ 890mm ↔  
→ ø 270mm  
D45, E14, 1 x 40W



4 004353 217388

### 3. 94862/76

‡ 440mm ↔  
→ 160mm ø 270mm  
D45, E14, 1 x 40W



4 004353 217357

### 4. 94862/77

‡ 440mm ↔  
→ 160mm ø 270mm  
D45, E14, 1 x 40W



4 004353 217364

1



2



3



4





1-3



1-2

## Martu

chrome  
metal

### 1. 22790/15

↓ 1200mm ↔  
→ ø 400mm  
A60, E27, 1 x 60W



4 004353 217432

### 2. 22770/15

↓ 950mm ↔  
→ ø 255mm  
A60, E27, 1 x 60W



4 004353 183102

### 3. 22710/15

↓ 230mm ↔  
→ 220mm ø 175mm  
A60, E27, 1 x 60W



4 004353 182464

1



2



3



**!** LED  
FILAMENT  
BULBS  
Seite / page  
326



1-2

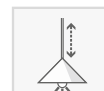

1-2

## Jesper

concrete grey  
metal/glass

### 1. 23770/70

↓ 1440mm ↔  
→ ø 470mm  
A60, E27, 1 x 60W  
98264/91



### 2. 23771/70

↓ 1500mm ↔  
→ ø 480mm  
A60, E27, 1 x 60W







2



1



3

## Jesper

concrete grey  
metal

### 1. 23758/70

↑ 1565mm ↔ 465mm  
→ 280mm ø  
A60, E27, 1 x 60W



4 004353 246739



1

### 2. 23710/70

↑ 345mm ↔ 295mm  
→ 175mm ø  
A60, E27, 1 x 60W



4 004353 246722



2

### 3. 23749/70

↑ 575mm ↔ 285mm  
→ 185mm ø  
A60, E27, 1 x 60W



4 004353 246715



3

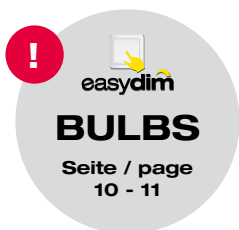



## Rings

concrete grey  
metal

### 1. 94944/70

↑ 450mm ↔  
→ 270mm ø 300mm  
A60, E27, 1 x 60W



### 2. 94945/70

↑ 1530mm ↔  
→ 310mm ø 620mm  
A60, E27, 1 x 60W



 **LED  
FILAMENT  
BULBS**  
Seite / page  
326

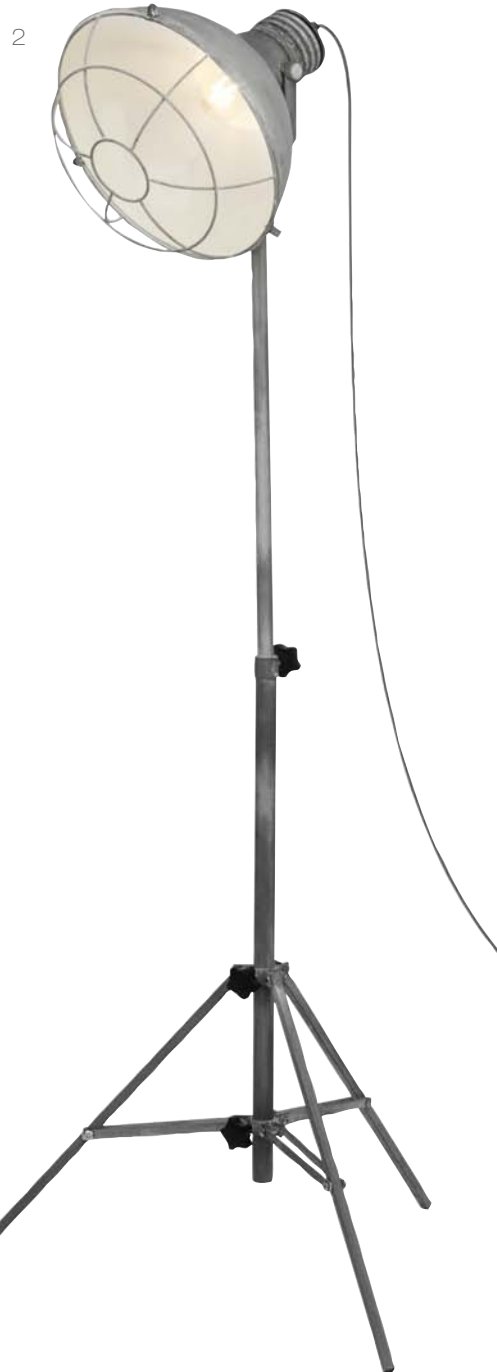



1-2



2

## Storm

concrete grey  
metal/glass

### 1. 93651/70

‡ 360mm ↔  
→ ø 160mm  
A60, E27, 1 x 60W



4 004353 251382

### 2. 93652/70

‡ 1220mm ↔  
→ ø 205mm  
A60, E27, 1 x 60W



4 004353 251399

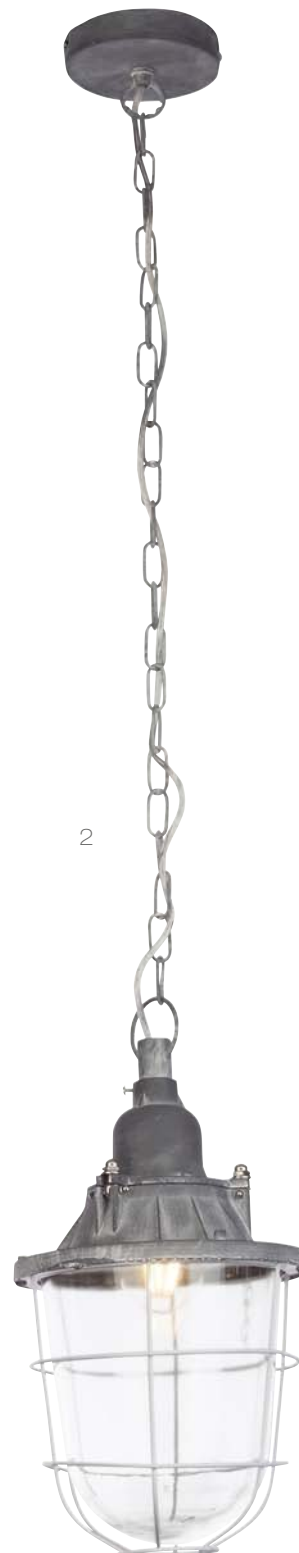

 **LED  
FILAMENT  
BULBS**  
Seite / page  
326



1-2



1-2

# Polygon

oak/white/birch/anthracite  
wood/textile

**1.31970/35** □

‡ 840mm ↔  
→ ø 425mm  
A60, E27, 1 x 60W



4 004353 251016

**2.31970/63** □

‡ 840mm ↔  
→ ø 425mm  
A60, E27, 1 x 60W



4 004353 251009





# Polygon

oak/white  
wood/textile

1. 31958/35 

↑ 1515mm ↔  
→ ø 590mm  
A60, E27, 1 x 60W



2. 31949/35 

↑ 550mm ↔  
→ ø 350mm  
A60, E27, 1 x 60W





1



1



2



3

## Sansibar

wooden painted/white  
plastic/wood

### 1. 93646/75

‡ 1900mm ↔  
→ ø 420mm  
A60, E27, 1 x 60W



4 004353 251061

### 2. 93647/75

‡ 570mm ↔  
→ ø 300mm  
D45, E14, 1 x 40W



4 004353 251078

### 3. 93648/75

‡ 1620mm ↔  
→ ø 410mm  
A60, E27, 1 x 60W



4 004353 251085



1



2



3

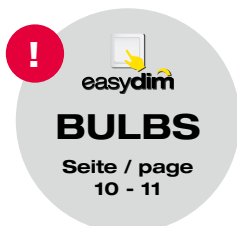

DECORATIVE







1



1



2-3

## Rider

cream shiny/chrome/transparent  
metal/glass

### 1. 04370/75

‡ 1000mm ↔  
→ ø170mm  
D45, E14, 1 x 25W  
♣92594/00



4 004353 151118

### 2. 04347/75

‡ 280mm ↔  
→ ø170mm  
QD45, E14, 1 x 28W  
♣92594/00



4 004353 151071

### 3. 04358/75

‡ 1500mm ↔  
→ ø170mm  
QD45, E14, 1 x 28W  
♣92594/00



4 004353 151095

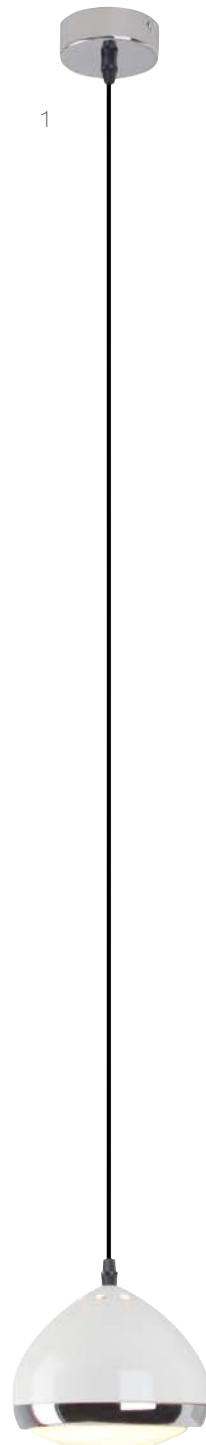



1



1



2-3

## Rider

black/chrome/transparent  
metal/glass

### 1. 04370/06

↑ 1000mm ↔  
→ ø170mm  
D45, E14, 1 x 25W  
↗ 92594/00



4 004353 151125

### 3. 04347/06

↑ 280mm ↔  
→ ø170mm  
QD45, E14, 1 x 28W  
↗ 92594/00



4 004353 151088

### 4. 04358/06

↑ 1500mm ↔  
→ ø170mm  
QD45, E14, 1 x 28W  
↗ 92594/00



4 004353 151101

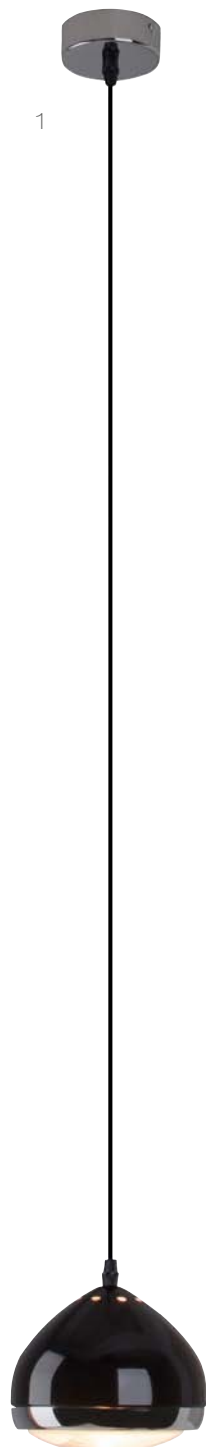

1



2



3

SEE OTHER VERSIONS  
ON PAGE  
**96**



# PENDANTS







## Venus

chrome/white  
metal/acrylic

### 1. G93655/15

↑ 1510mm ↔  
→ ∅ 740mm

LED integr, 1 x 42W   
1 x 3540 lm, 3000 K, **A**  
↗ 98321/00



# PENDANTS



**LED**  
incl.

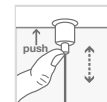

1-2

1-2

## Elegant

chrome/transparent  
metal/glass

### 1. G93525/15

‡ 1520mm ↔  
→ ø 180mm  
LED integr., 1 x 5W   
1 x 520 lm, 3000 K, **A+**  
↗ 98148/00



### 2. G93526/15

‡ 1250mm ↔  
→ ø 250mm  
LED integr., 3 x 5W   
3 x 520 lm, 3000 K, **A+**  
↗ 98148/00, 98149/00

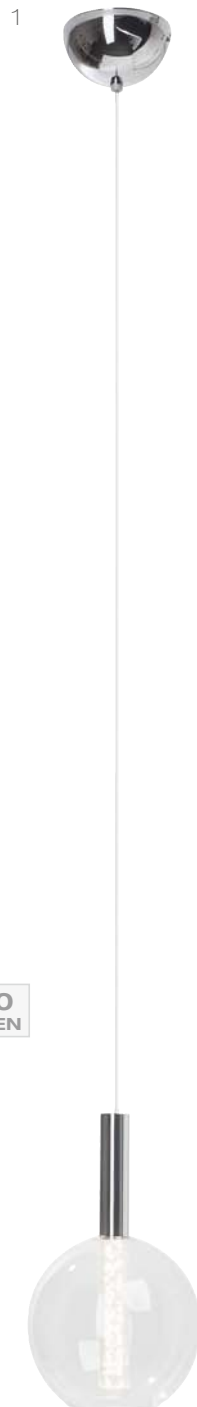

520  
LUMEN



1560  
LUMEN







1-2

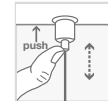

1-2

## Elegant

chrome/transparent  
metal/glass

### 1. G93527/15

‡ 1360mm ↔ 900mm  
→ 180mm ø  
LED integr., 4 x 5W   
4 x 520 lm, 3000 K, **A+**  
↗ 98148/00, 98150/00



4 004353 212802

## Elegance

chrome/transparent  
metal/glass

### 2. G93528/15

‡ 1470mm ↔ 870mm  
→ 125mm ø  
LED integr., 4 x 5W   
4 x 520 lm, 3000 K, **A+**  
↗ 98151/00, 98152/00



4 004353 212819

2080  
LUMEN

1

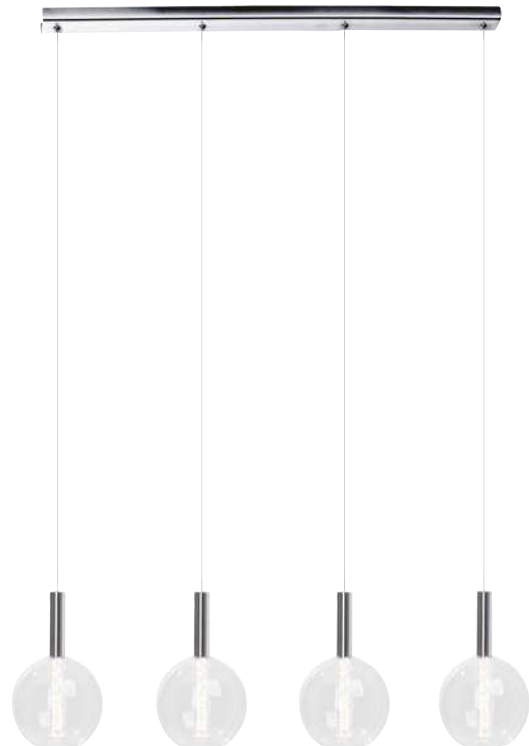

2

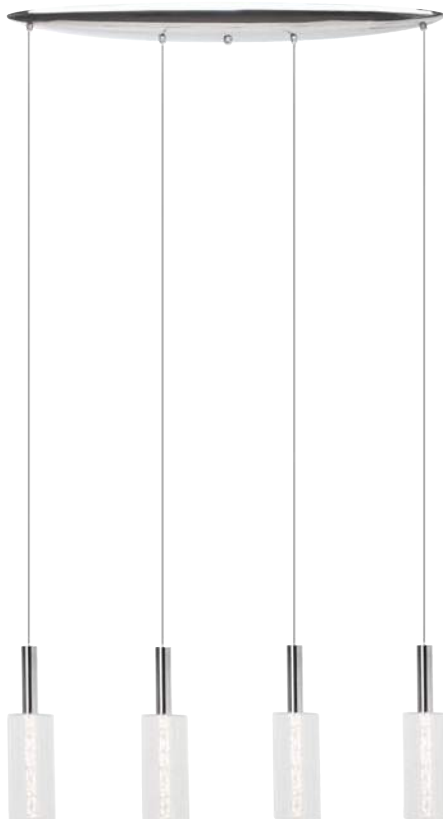

2080  
LUMEN



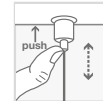

## Delta

chrome  
metal/acrylic

### 1. G93624/15

‡ 1220mm ↔ 1005mm

→ 60mm ø

LED integr., 1 x 29W

1 x 1938 lm, 3000 K, A

↗ 98287/00



4 004353 249877

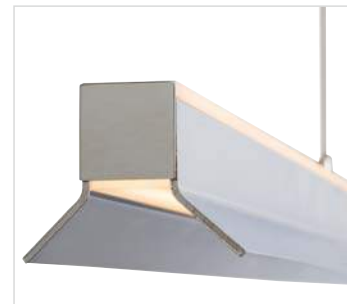
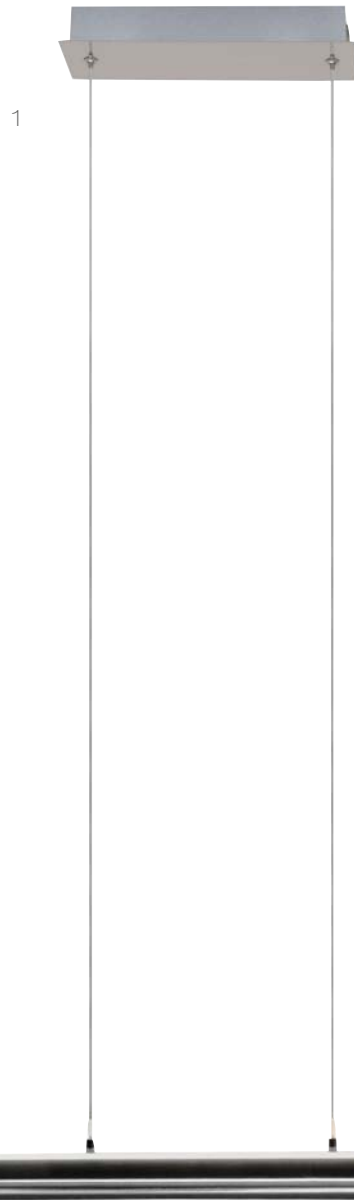

1938  
LUMEN





1-2

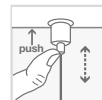

1-2



2

## Style II

chrome  
metal/acrylic

### 1. G93505/15

‡ 1500mm ↔  
→ ø 120mm  
LED integr., 1 x 5W   
1 x 325 lm, 3000 K, **A+**



4 004353 205392

### 2. G93506/15

‡ 1500mm ↔ 950mm  
→ 80mm ø  
LED integr., 5 x 5W   
5 x 325 lm, 3000 K, **A+**  
/98127/00



4 004353 205408



1

325  
LUMEN



2



1620  
LUMEN



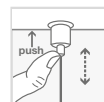

## Ice Glass

chrome  
metal/glass

### 1. G93542/15

‡ 1200mm ↔ 1150mm

→ 350mm ∅

LED integr., 3 x 6W

3 x 480 lm, 3000 K, 



4 004353 216947



# PENDANTS



**LED**  
incl.

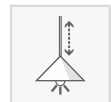

## Inaya

chrome  
metal/plastic

1. G93575/15 

± 1500mm ↔

→ ∅ 1000mm

LED integr., 1 x 69W 

1 x 6150 lm, 3000 K, 

↗ 98249/15, 98259/15



1

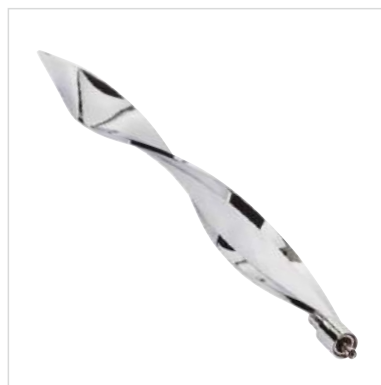

**6150**  
LUMEN



**XXL**  
FORMAT  
1000 MM



1-2

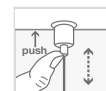

1-2

## New Haven

chrome/white  
metal/plastic

### 1. G93452/75

↑ 1200mm ↔ 330mm

→ ∅

LED integr., 1 x 28,84W

1 x 2590 lm, 4000 K, A+

↗ 98330/00



4 004353 194115

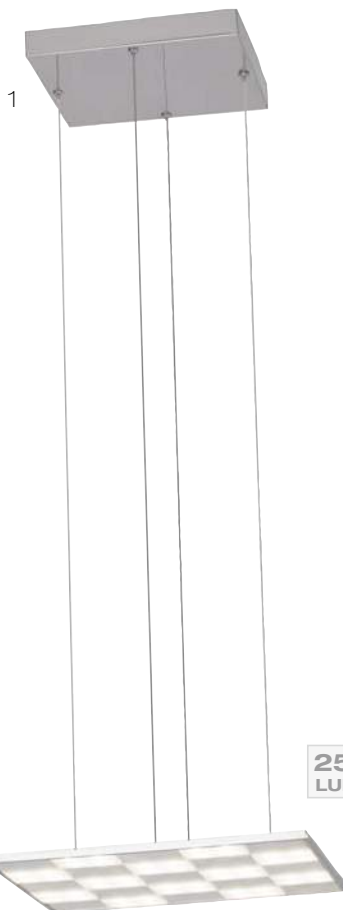

2590  
LUMEN

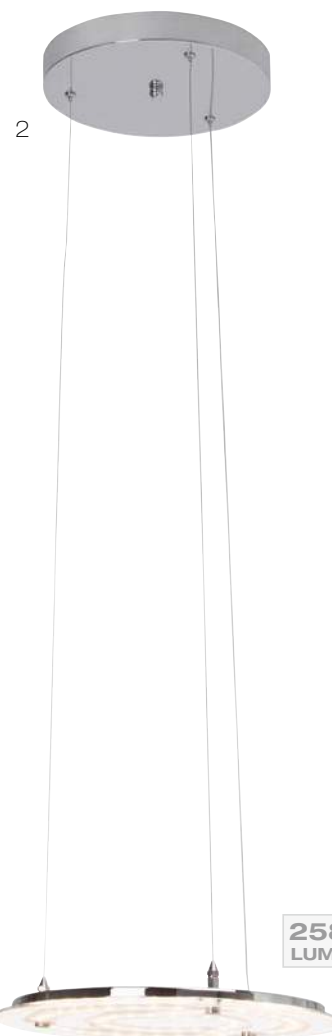

2584  
LUMEN





**LED**  
incl.



## Gardis

aluminium/chrome/white  
metal/glass

### 1. G93673/77

‡ 1500mm ↔ 790mm

→ 100mm ø

LED integr., 1 x 21,6W

1 x 1710 lm, 3000 K, **A**



1710  
LUMEN

**LED**  
incl.  
1-2



## Galina

chrome/white  
metal/glass

### 1. G93671/15

↓ 1500mm ↔ 750mm  
→ 100mm ø  
LED integr., 4 x 5W   
4 x 400 lm, 3000 K, **A+**  
↗ 98250/05



### 2. G93672/15

↓ 1500mm ↔ 750mm  
→ 100mm ø  
LED integr., 4 x 5W   
4 x 400 lm, 3000 K, **A+**  
↗ 98251/05



2



**1600**  
LUMEN

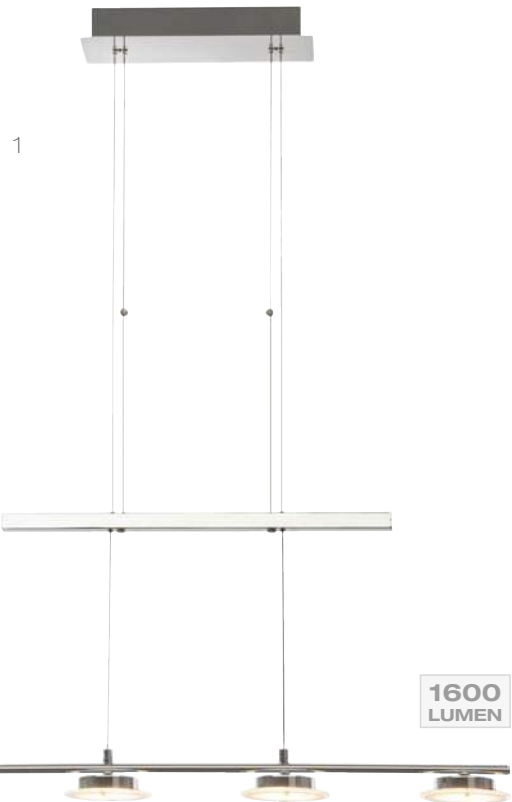

**1600**  
LUMEN





1-2



1-2

## Bernadette

chrome/transparent  
metal/glass

### 1. G93451/75

↑ 600 - 1500mm ↔ 800mm  
→ 80mm ø  
LED integr., 4 x 4,5W   
4 x 300 lm, 3000 K, **A+**  
↗ 98090/98, 98218/00



## Hanjo

chrome/transparent  
metal/glass

### 2. G93030/15

↑ 460 - 670mm ↔ 800mm  
→ 150mm ø  
LED integr., 4 x 5W   
4 x 350 lm, 3000 K, **A+**  
↗ 98066/00





1-2



1-2

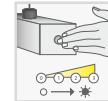

1-2

## Tonja

chrome/white  
metal/glass

### 1. G70579/15

↑ 900 - 1750mm ↔ 584mm  
→ 85mm ø  
LED integr., 3 x 5W   
3 x 285 lm, 3000 K, **A**  
↗ 98073/05



### 2. G70573/15

↑ 900 - 1750mm ↔ 980mm  
→ 85mm ø  
LED integr., 5 x 5W   
5 x 285 lm, 3000 K, **A**  
↗ 98073/05

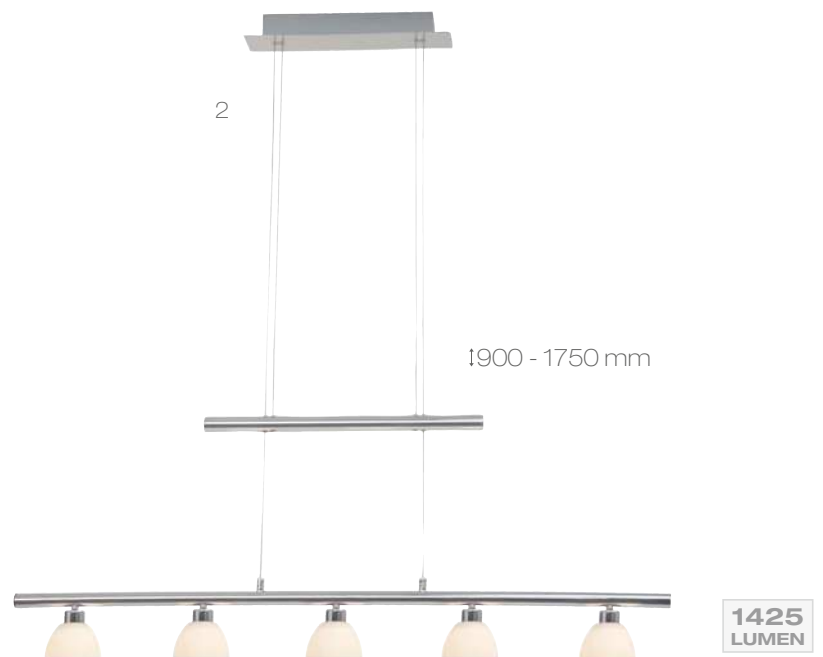
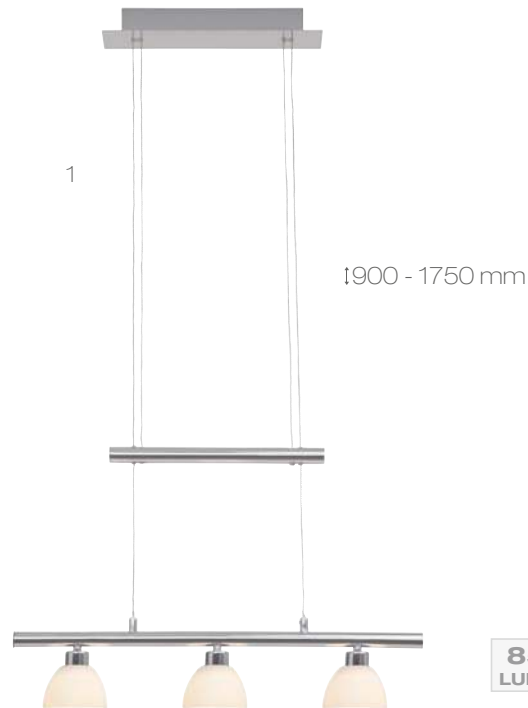

**LED**  
incl.  
1-2

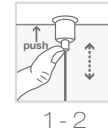

## Arlena

chrome/transparent  
metal/glass

### 1. G93435/15

↓ 1150mm ↔ 1050mm  
→ ∅

LED integr., 5 x 6W

5 x 435 lm, 3000 K, **A+**

↗ 98050/98, 98316/00



### 2. G93434/15

↓ 1150mm ↔ 600mm  
→ ∅

LED integr., 3 x 6W

3 x 440 lm, 3000 K, **A+**

↗ 98050/98

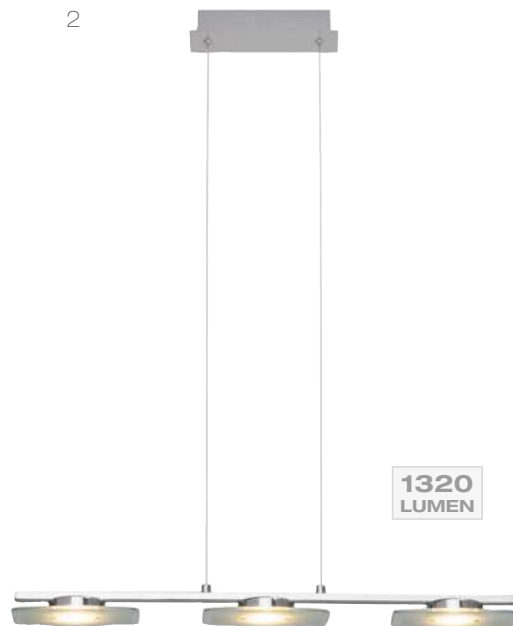

**LED**  
incl.

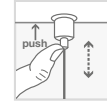

## Thalassa

chrome/transparent  
metal/glass

### 1. G93031/15

‡ 900 - 1500mm ↔

→ ø400mm

LED integr., 1 x 18W

1 x 1500 lm, 3000 K, 



1

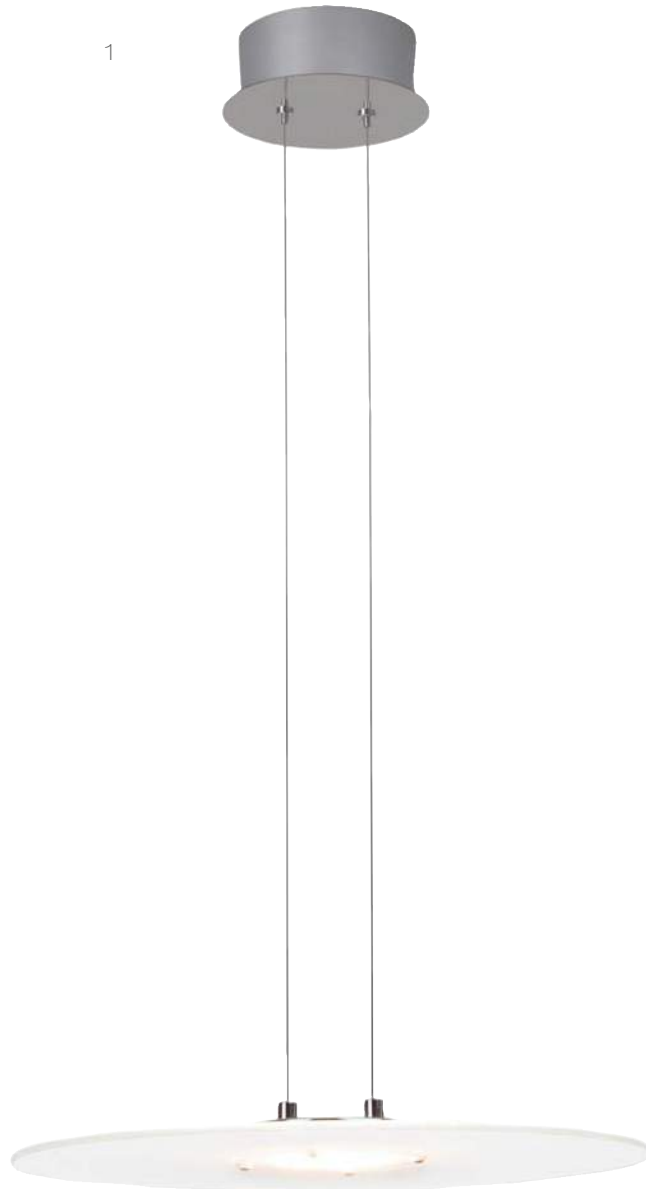

**1500**  
LUMEN



1-2



1-2



1-2

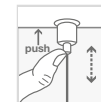

1-2

## Liquid

satin nickel/white  
metal/acrylic

### 1. G93539/13

‡ 1580mm ↔ 850mm  
→ 100mm ø  
LED integr., 5 x 7.5W   
5 x 800 lm, 3000 K, **A+**  
↗ 98340/00



### 2. G93540/13

‡ 1610mm ↔ 1170mm  
→ 100mm ø  
LED integr., 7 x 7.5W   
7 x 800 lm, 3000 K, **A+**  
↗ 98340/00, 98388/00







1-2



1-2



1-2

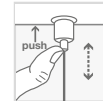

1-2

## Surf

satin nickel  
metal/glass

### 1. G93510/13

‡ 1440mm ↔ 865mm  
→ 80mm ø

LED integr., 5 x 7,5W   
5 x 800 lm, 3000 K, **A+**   
↗ 98129/91, 98130/00



4 004353 205460

### 2. G93511/13

‡ 1500mm ↔ 1200mm  
→ 80mm ø

LED integr., 7 x 7,5W   
7 x 800 lm, 3000 K, **A+**   
↗ 98129/91, 98131/00



4 004353 205477



1

4000  
LUMEN



2

5600  
LUMEN





1-3

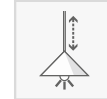

1-3

## Better

satin nickel/white  
metal/acrylic

### 1. G17573/13

- ‡ max. 1450mm ↔ 730mm
- 120mm ø
- LED integr., 3 x 6W
- 3 x 480 lm, 2700 K, **A+**
- LED integr., 3 x 1W
- 3 x 80 lm, 2700 K, **A++**
- ↗98357/00



4 004353 238871

### 2. G17572/13

- ‡ max. 1450mm ↔ 450mm
- 120mm ø
- LED integr., 2 x 6W
- 2 x 480 lm, 2700 K, **A+**
- LED integr., 2 x 1W
- 2 x 80 lm, 2700 K, **A++**
- ↗98356/00



4 004353 238864

### 3. G17570/13

- ‡ max. 1450mm ↔
- ø 150mm
- LED integr., 1 x 6W
- 1 x 480 lm, 2700 K, **A+**
- LED integr., 1 x 1W
- 1 x 80 lm, 2700 K, **A++**



4 004353 238857

1



1440  
LUMEN

2



960  
LUMEN

3



480  
LUMEN







## Trend

satin nickel/white  
metal/glass

### 1. G93517/13

‡ 900-1600mm ↔ 785mm  
→ 65mm ø

LED integr., 3 x 6W 

3 x 540 lm, 3000 K, 

↗ 98135/05, 98387/00

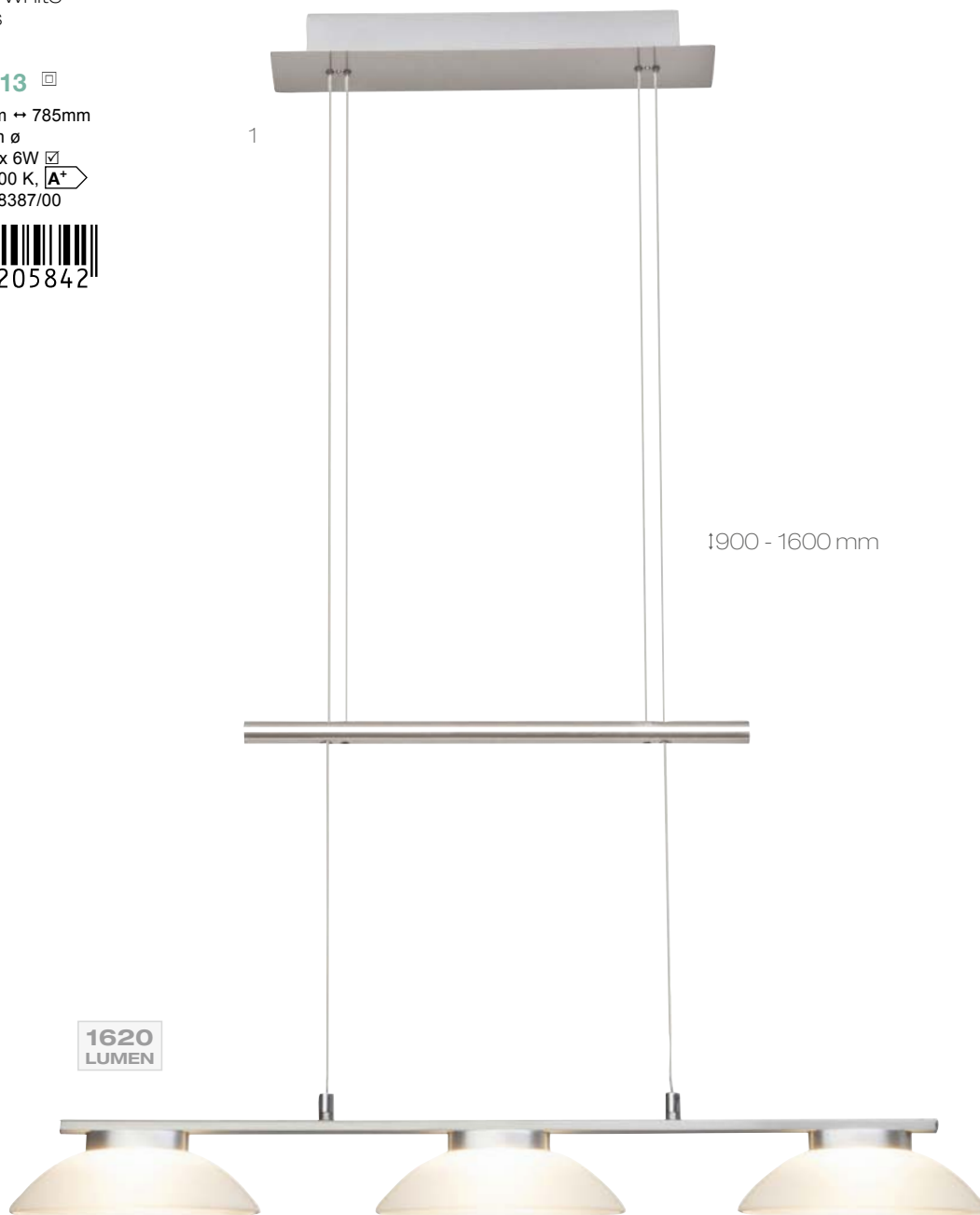

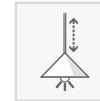
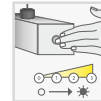
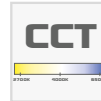

## Quasar

satin nickel/white  
metal/acrylic

### 1. G93641/13

‡ 850 - 1500mm ↔ 1000mm  
→ 25mm ø

LED integr, 1 x 24W

1 x 1942 lm, 3000 - 6500K, A



**LED**  
incl.

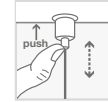

## Curved

satin nickel/white  
metal/acrylic

### 1. G93504/13

‡ max. 1500mm ↔ 1200mm  
→ 80mm ø

LED integr., 1 x 21,6W   
1 x 1660 lm, 3000 K, **A**   
↗ 98366/00



1

**1660**  
LUMEN





## Narja

satin nickel/white  
metal/plastic

### 1. G93455/13

↑ 900 - 1650mm ↔ 980mm  
→  
LED integr., 5 x 4,5W  
5 x 385 lm, 3000 K, A+  
↗ 98332/00



4 004353 194290





1-2

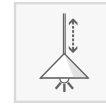

1-2

## Panaro

satin nickel  
metal/glass

### 1. G93548/13

‡ 1510mm ↔ 800mm  
→ 120mm ø  
LED integr., 4 x 4,5W   
4 x 360 lm, 3000 K, **A+**



4 004353 218569

## Betsy

satin nickel/white  
metal/glass

### 1. G93547/13

‡ 1500mm ↔ 900mm  
→ 90mm ø  
LED integr., 4 x 4,5W   
4 x 360 lm, 3000 K, **A+**  
/98173/05



4 004353 218552



1

1440  
LUMEN



2

1440  
LUMEN



**LED**  
incl.



## Plate

chrome/aluminium  
metal/plastic

### 1. G93541/21

‡ 1200mm ↔ 700mm

→ 100mm ø

LED integr., 3 x 6,5W 

3 x 650 lm, 3000 K, 



4 004353 216770



1950  
LUMEN

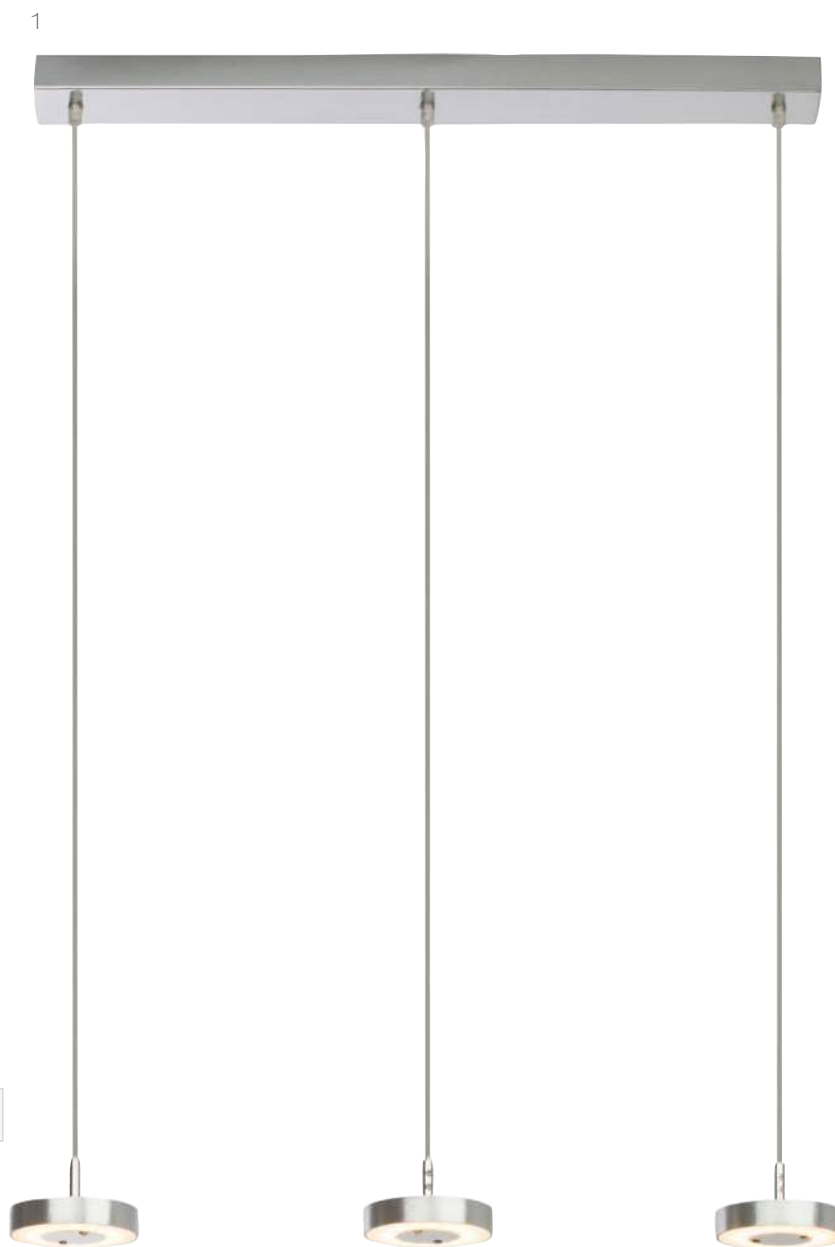



1-2



1-2



1-2

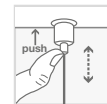

1-2

## Sunrise

aluminium/white  
metal/acrylic

### 1. G93535/21

‡ 1500mm ↔ 900mm  
→ 60mm ø

LED integr., 1 x 40W   
1 x 3350 lm, 3000 K, **A**



### 2. G93536/21

‡ 1500mm ↔ 1210mm  
→ 60mm ø

LED integr., 1 x 45W   
1 x 3765 lm, 3000 K, **A**  
98339/00



**LED**  
incl.

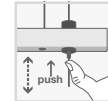

1-2

1-2

## Transit

nickel/aluminium  
aluminium/pastic

### 1. G67473/21

‡ 800 - 1400mm ↔ 740mm  
→ 75mm ø  
LED integr., 5 x 4W   
5 x 320 lm, 3000 K, **A+**  
↗ 98376/00



4 004353 212581

## Crossing

nickel/aluminium  
aluminium/pastic

### 2. G08573/21

‡ 800 - 1400mm ↔ 770mm  
→ 77mm ø  
LED integr., 5 x 4W   
5 x 320 lm, 3000 K, **A+**  
↗ 98376/00



4 004353 217104

1



**1600**  
LUMEN

1800 - 1400mm



SEE OTHER VERSIONS  
ON PAGE  
**40**

2



**1600**  
LUMEN

1800 - 1400mm



SEE OTHER VERSIONS  
ON PAGE  
**41, 411**

**LED**  
incl.

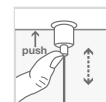

## String

grey  
metal/plastic

### 1. G93550/22

‡ 1320mm ↔ 820mm

→ ∅

LED integr., 1 x 16W 

1 x 1540 lm, 3000 K, 



1



**1540**  
LUMEN



1-2

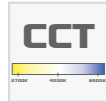

1-2



1-2



1-2

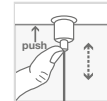

1-2

## Smooth

satin nickel/white  
metal/acrylic

### 1. G20870/13

- ‡ 1500mm ↔
- ∅ 400mm
- LED integr., 1 x 30W
- 1 x 2400 lm, 2700-6200 K, **A**
- ↗ 98358/00



4 004353 240188

### 2. G20871/05

- ‡ 1500mm ↔
- ∅ 600mm
- LED integr., 1 x 46W
- 1 x 3700 lm, 2700-6200 K, **A**



4 004353 240249

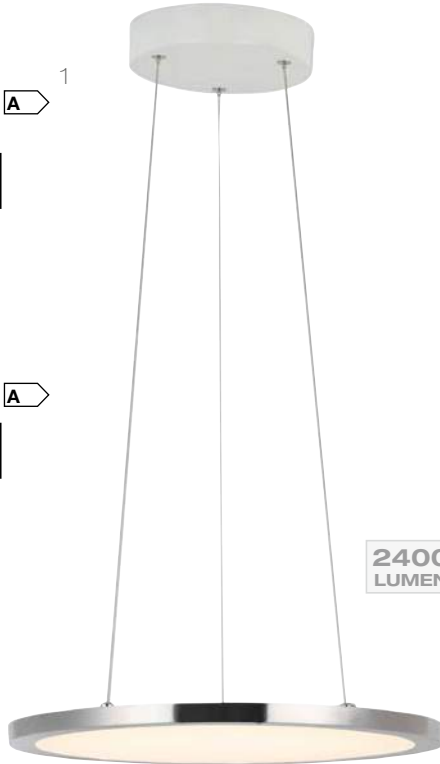

2400  
LUMEN

only satin nickel

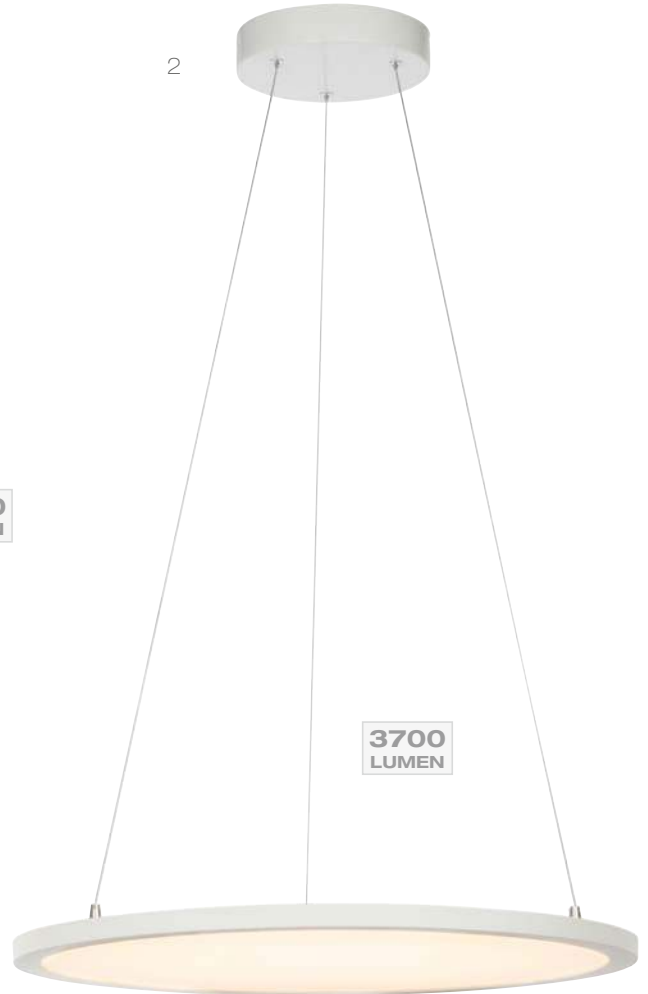

3700  
LUMEN

only white

SEE OTHER VERSIONS  
ON PAGE  
**368-370**

**XXL**  
FORMAT  
600 MM





1-2

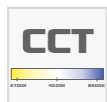

1-2



1-2



1-2

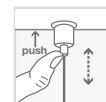

1-2

## Smooth

white  
metal/acrylic

### 1. G20872/05

‡ 1500mm ↔ 900mm  
→ 150mm ø  
LED integr., 1 x 30W   
1 x 2300 lm, 2700-6200 K,   
↗ 98358/00



4 004353 240256

### 2. G20873/05

‡ 1500mm ↔ 1200mm  
→ 150mm ø  
LED integr., 1 x 36W   
1 x 2900 lm, 2700-6200 K,   
↗ 98358/00



4 004353 240263

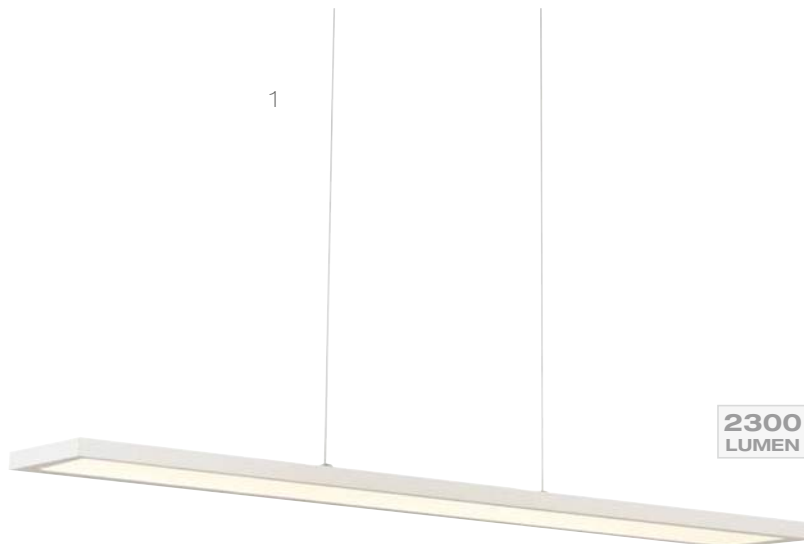



1-3

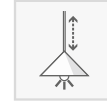

1-3

## Robinia

satin nickel/chrome/white metal/glass

### 1. G74479/77

↑ 850 - 1750mm ↔  
→ 170mm ø  
LED, E14, 1 x 4,5W   
1 x 340 lm, 3000 K, **A+**  
↗ 92561/05



4 004353 194146

### 2. G74471/77

↑ 850 - 1750mm ↔ 470mm  
→ 170mm ø  
LED, E14, 2 x 4,5W   
2 x 340 lm, 3000 K, **A+**  
↗ 92561/05



4 004353 194153

### 3. G74476/77

↑ 850 - 1750mm ↔ 800mm  
→ 170mm ø  
LED, E14, 3 x 4,5W   
3 x 340 lm, 3000 K, **A+**  
↗ 92561/05



4 004353 194160

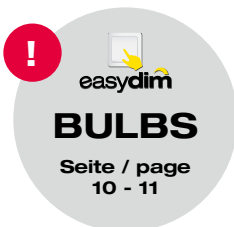



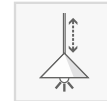

## Giorgia

satin nickel/chrome/white  
metal/glass/white

### 1. G05573/77

‡ 750 - 1600mm ↔ 900mm  
→ 0

LED, E14, 5 x 3W   
5 x 260 lm, 3000 K, **A+**  
↗ 98024/98



SEE OTHER VERSIONS  
ON PAGE  
**45**



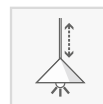

## Nash XL

chrome/transparent  
metal/glass

### 1. G93418/15

± 1650mm ↔

→ ø780mm

QT-LP9, G4, 24 x 10W

24 x 120 lm, 2800 K

98049/00





## Nash XXL

chrome/transparent  
metal/glass

1. G93328/15

± 1700mm ↔

→ ø1200mm

QT-LP9, G4, 48 x 10W

48 x 120 lm, 2800 K

98176/00



4 004353 130656





## Ghost

chrome/transparent  
metal/glass

1.93584/15 

‡ 1500mm ↔ 780mm

→ 118mm ø

QT14, G9, 4 x 33W

↗ 98214/00, 98215/82

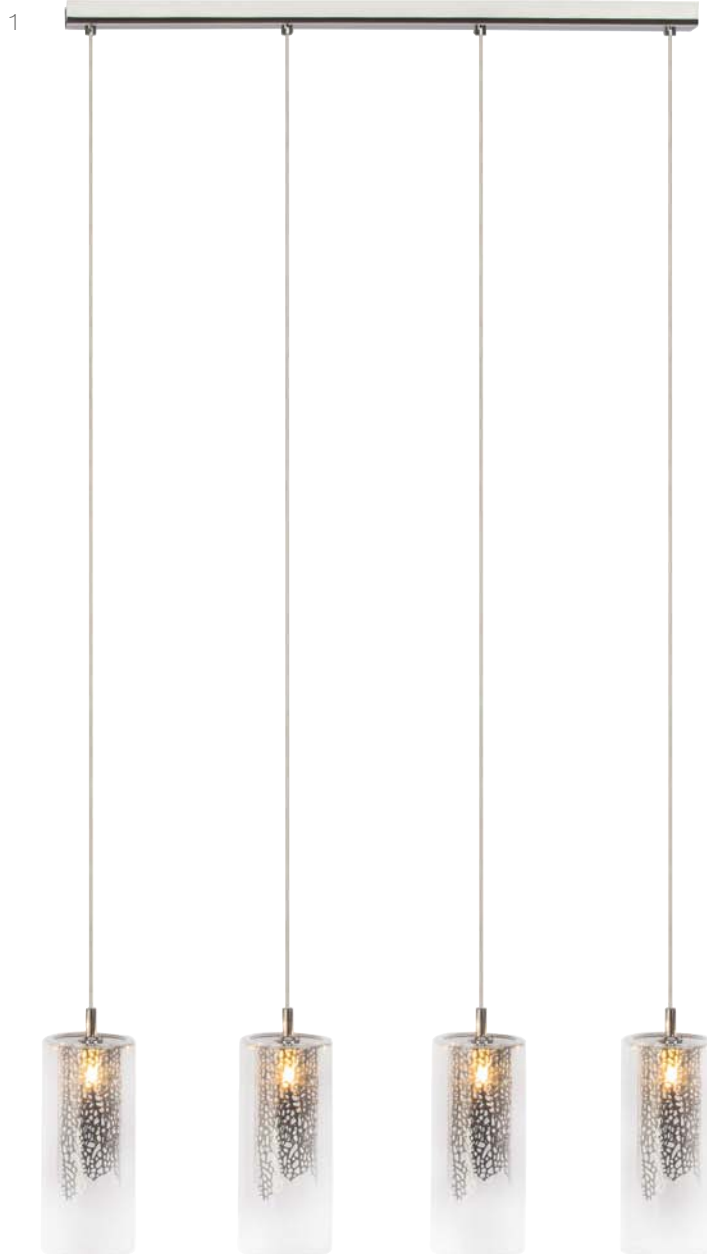

# PENDANTS







1 - 2

## Bombilla

chrome/transparent  
metal/glass

### 1. 93619/15

‡ 1415mm ↔  
→ ∅ 200mm  
LED, GU10, 1 x 7W  
/98369/00



4 004353 249112

### 2. 93609/15

‡ 1300mm ↔ 610mm  
→ 140mm ∅  
LED, GU10, 3 x 7W  
/98254/00



4 004353 245374

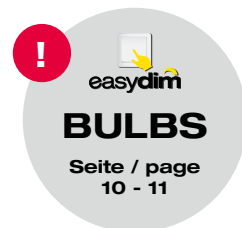



1 - 2

## Joker

chrome/transparent  
metal/glass

### 1. 93553/15

↓ 1400mm ↔  
→ ∅ 100mm  
LED, GU10, 1 x 7W  
↗ 92560/15, 98174/00



### 2. 93554/15

↓ 1340mm ↔ 610mm  
→ 100mm ∅  
LED, GU10, 3 x 7W  
↗ 92560/15, 98174/00



Non included accessoires







1-2



1-2



1-2

## Gitse

chrome/white  
metal/glass

### 1. 93669/15

↓ 1020mm ↔  
→ ø 100mm  
QT14, G9, 1 x 28W  
↗ 98368/05



4 004353 254239

### 2. 93670/15

↓ 1020mm ↔  
→ ø 190mm  
QT14, G9, 3 x 28W  
↗ 98368/05



4 004353 254253



1



2



# PENDANTS





1-2



1-2

## Jane

chrome/white/transparent  
metal/glass

### 1. 93661/15

‡ 1060mm ↔  
→ ø 108mm  
A60, E27, 1 x 60W  
✈ 98297/05, 98312/05,  
98314/15



4 004353 247651

### 2. 93662/15

‡ 1075mm ↔725mm  
→ 108mm ø  
A60 E27 3 x 60W  
✈ 98297/05, 98312/05,  
98314/15



4 004353 247668





## Janis

chrome/white/transparent  
metal/glass

1.38776/13 

‡ 1100mm ↔500mm  
→ 120mm ø  
C35, E14, 3 x 40W  
↗98059/05, 98060/00



1

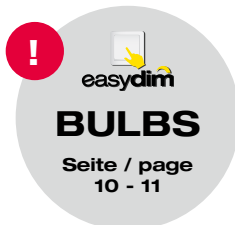
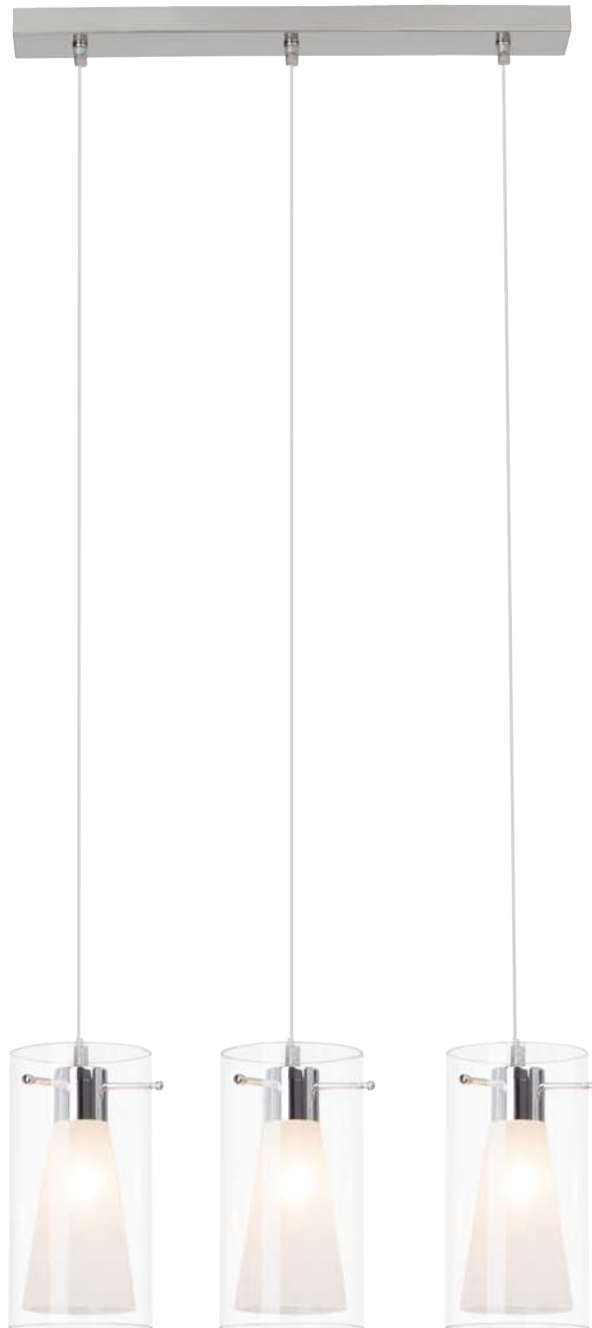

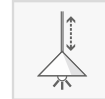

## Lunao

chrome/transparent  
metal/glass

1.93600/15 

‡ 1240mm ↔ 90mm  
→ ø 300mm  
A60, E27, 1 x 60W  
↗ 98227/00

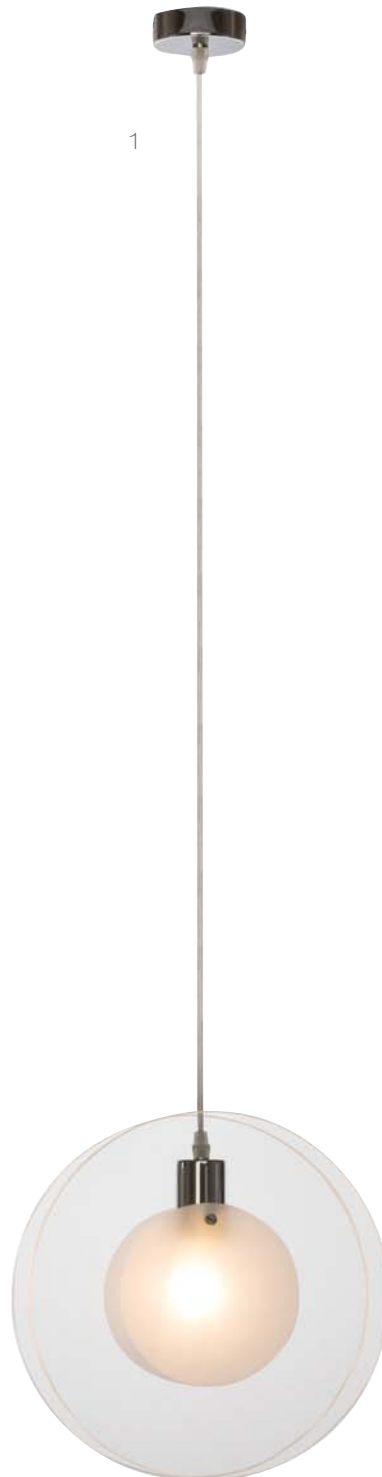



## First

satin nickel/white  
metal/glass

1.93518/75 

‡ 1200mm ↔ 650mm

→ 75mm ø

QT14, G9, 4 x 33W

↗ 98203/75



1

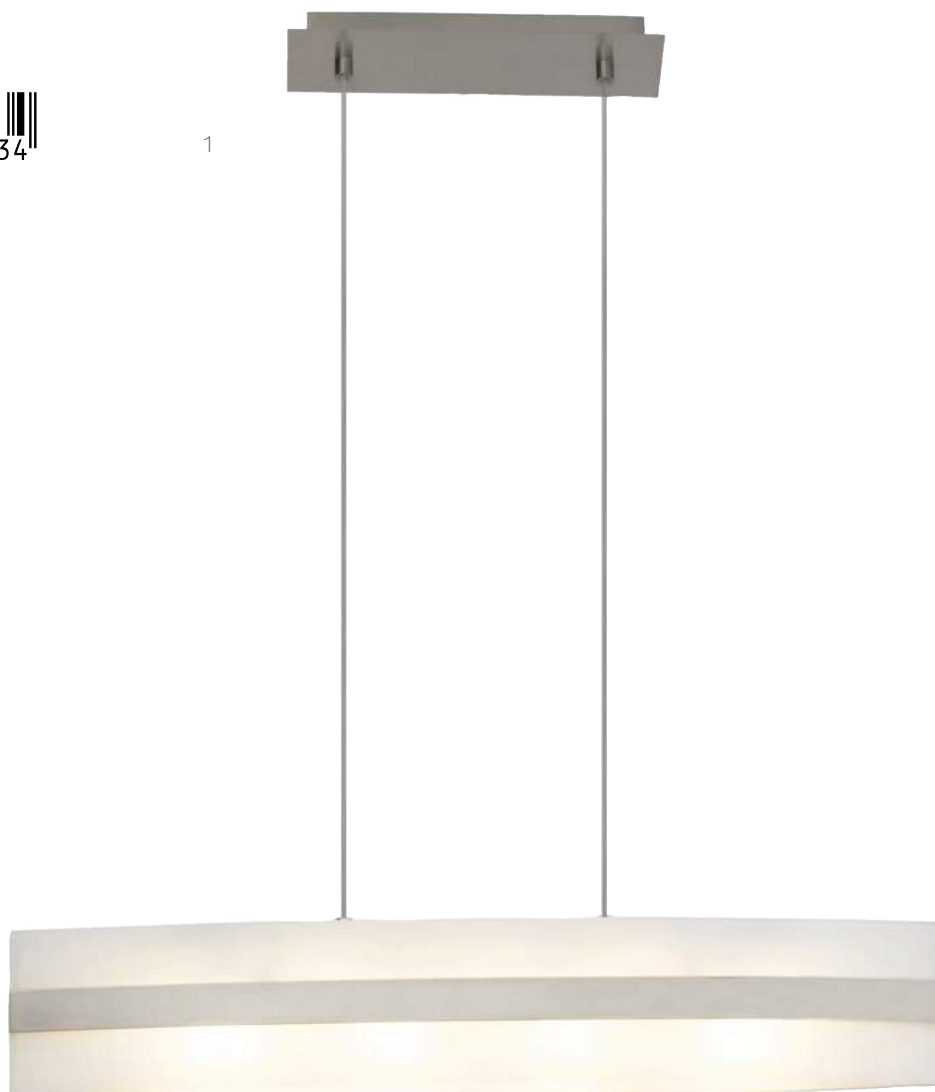



1-2



1-2

## Sun

satin nickel/white  
metal/glass

### 1. 93515/05

↑ max. 2280mm ↔  
→ ∅ 300mm  
A60, E27, 1 x 60W  
♣98128/05



### 2. 93516/05

↑ max. 2280mm ↔  
→ ∅ 300mm  
A60, E27, 1 x 60W  
♣98128/05

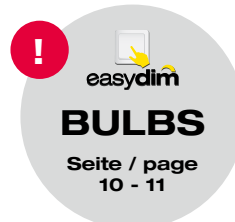





1-2



1-2

## Fantasia

silver/white  
metal/glass

### 1. 93275/05

‡ 1000mm ↔  
→ ø 200mm  
A60, E27, 1 x 60W  
↗ 92497/05



### 2. 93277/05

‡ 1440mm ↔  
→ ø 300mm  
A60, E27, 1 x 60W  
↗ 92499/05





1-2



1-2

## Mona

satin nickel/chrome/white  
metal/glass

### 1. 93248/77

‡ 1060 - 2580mm ↔ 520mm  
→ 90mm ø  
D45, E14, 3 x 40W  
♣92538/94



4 004353 107641

### 2. 93249/77

‡ 1060 - 2580mm ↔ 760mm  
→ 90mm ø  
D45, E14, 5 x 40W  
♣92538/94



4 004353 107658

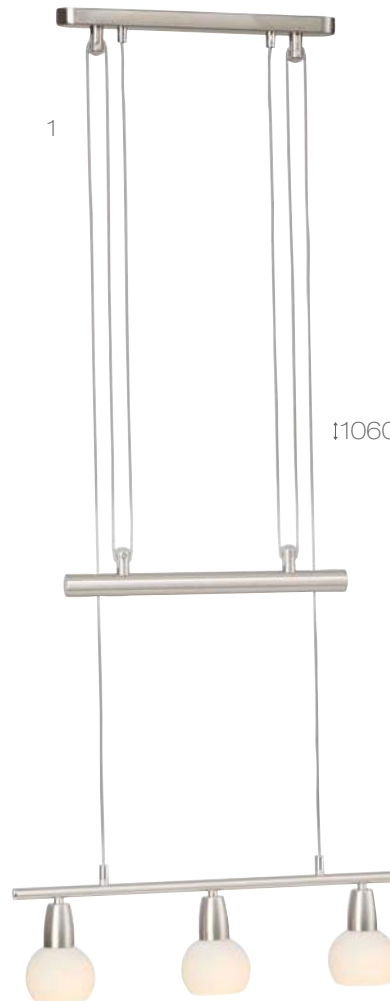

11060 - 2580 mm

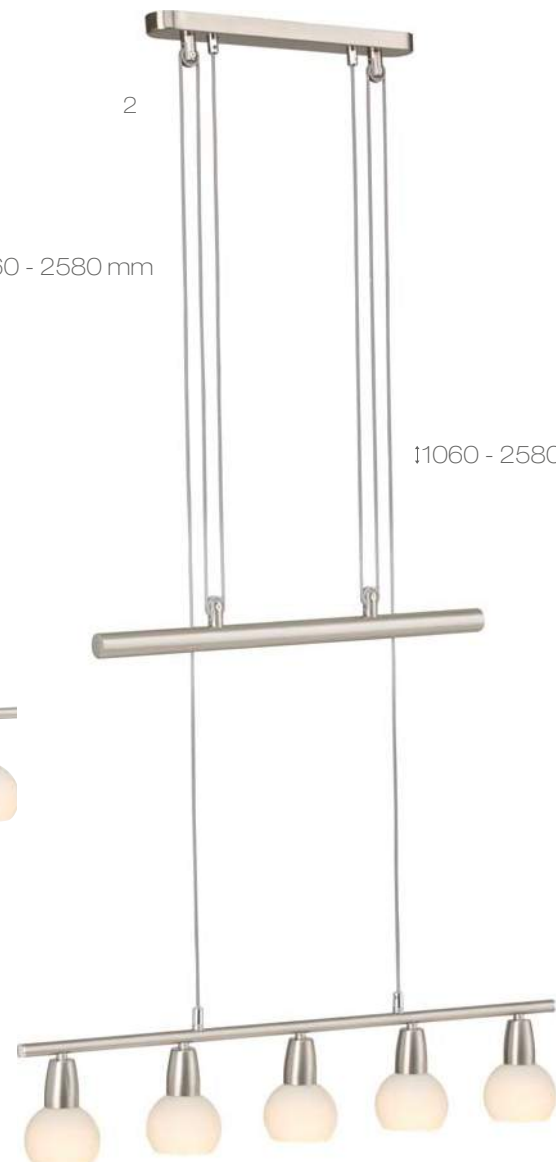

11060 - 2580 mm

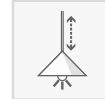

## Titanic

chrome/transparent  
metal/glass

1.93654/15 

↑ 1460mm ↔  
→ ∅ 360mm  
A60, E27, 1 x 40W  
↗ 98318/00





1-2



1-2

## Mandal

chrome/transparent  
metal/glass

### 1. 93639/15

‡ 1500mm ↔  
→ ø 350mm  
A60, E27, 1 x 60W  
↗98299/00



4 004353 250200

### 2. 93640/15

‡ 1300mm ↔ 250mm  
→ 560mm ø  
A60, E27, 2 x 60W  
↗98394/00



4 004353 250217





1-3

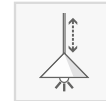

1-3

## Sandness

chrome/transparent/copper/smoke glass  
metal/glass

### 1. 93645/15

‡ 1550mm ↔  
→ ø 250mm  
A60, E27, 1 x 60W  
♣98308/00



4 004353 250996

### 2. 93645/29

‡ 1550mm ↔  
→ ø 250mm  
A60, E27, 1 x 60W  
♣98308/00



4 004353 251030

### 3. 93645/93

‡ 1550mm ↔  
→ ø 250mm  
A60, E27, 1 x 60W  
♣98308/93



4 004353 251047





1-2



1-2

## Riga

chrome/transparent  
metal/glass

### 1. 93642/15

↓ 1640mm ↔  
→ ∅ 145mm  
A60, E27, 1 x 60W  
98305/00



4 004353 250958

### 2. 93643/15

↓ 1610mm ↔  
→ ∅ 200mm  
A60, E27, 1 x 60W  
98304/00



4 004353 250941

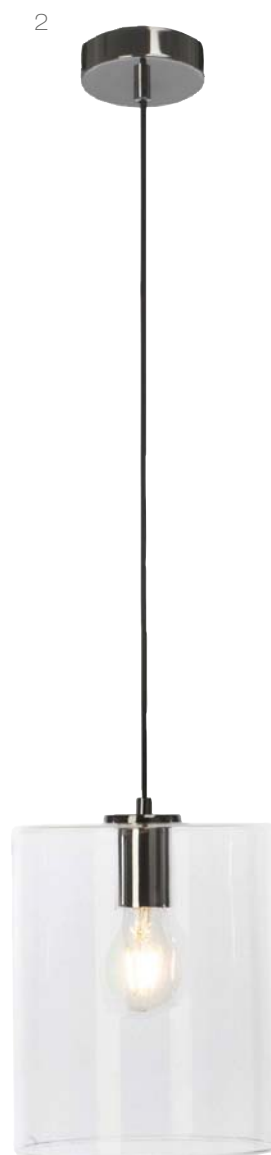



1-2



1-2

## Stockholm

chrome/transparent/blue  
metal/glass

### 1. 93650/00

‡ 1600mm ↔  
→ ∅ 280mm  
A60, E27, 1 x 60W  
♣98315/00



4 004353 251337

### 2. 93650/03

‡ 1600mm ↔  
→ ∅ 280mm  
A60, E27, 1 x 60W  
♣98315/03



4 004353 251351







## Trial

grey  
metal/textile

1.93377/22 

↑ 900mm ↔ 450mm

→ ∅

A60, E27, 3 x 60W



1



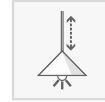

## Glitz

chrome/white/transparent  
metal/plastic/textile

1.93415/05 

‡ 1000mm ↔  
→ ø 400mm  
A60, E27, 1 x 60W





## Zarina

satin nickel/black/white  
metall/tortoise shell

1.93219/13 ☹

↑ 1800mm ↔

→ ø560mm

A60, E27, 1 x 60W



# PENDANTS

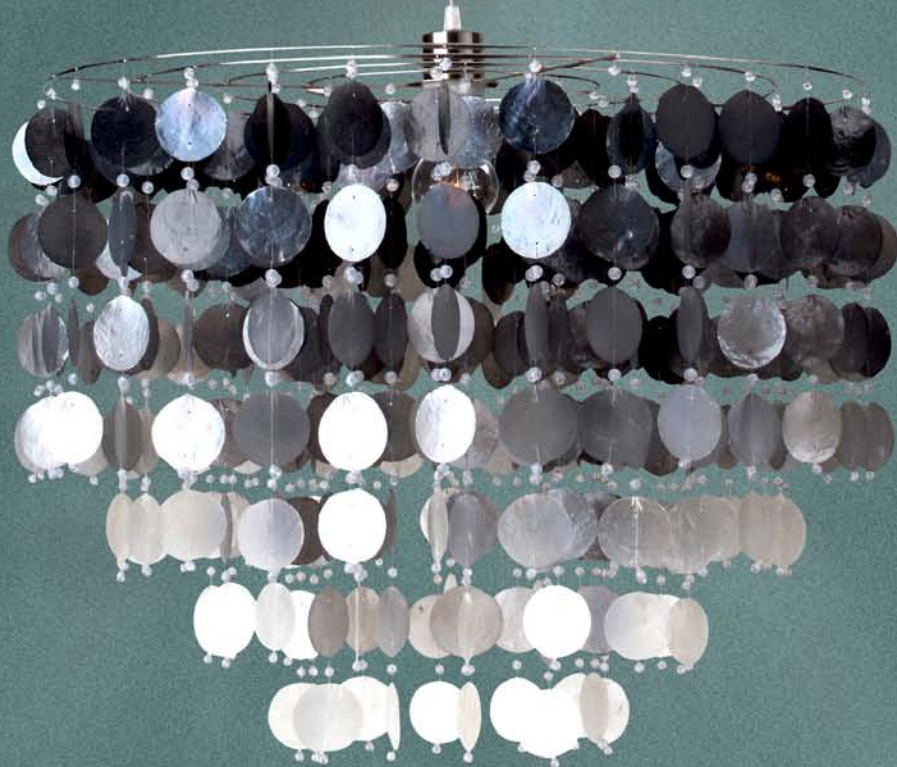



## Bumble

beige  
rattan/plastic

1.93232/09 

↑ 1400mm ↔  
→ ø 310mm  
A60, E27, 1 x 60W





# PENDANTS

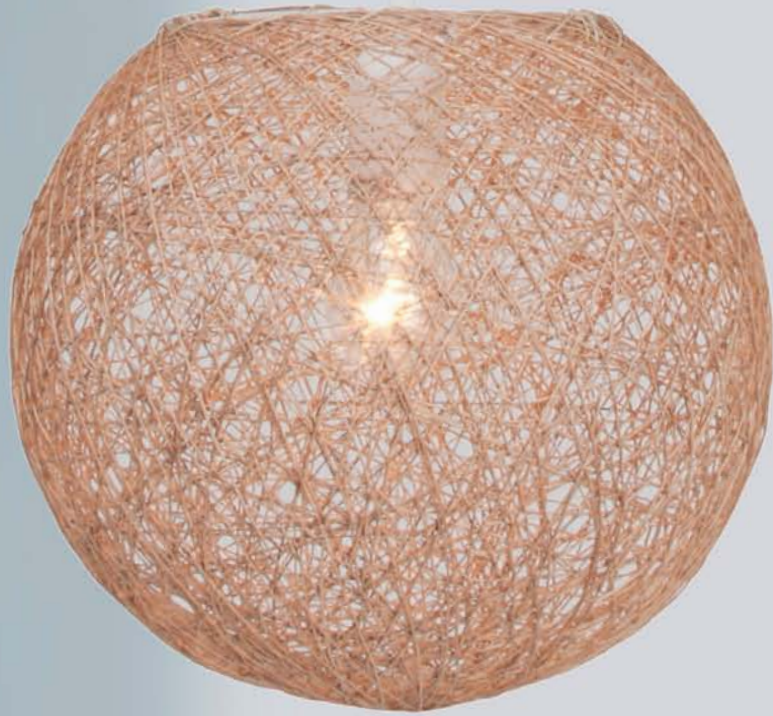



1-2



1-2

## Inbal

black/white  
metal/glass

### 1. HK12707S06

‡ 1280mm ↔  
→ ø 425mm  
A60, E27, 1 x 60W



4 004353 191275

### 2. HK12707S05

‡ 1280mm ↔  
→ ø 425mm  
A60, E27, 1 x 60W



4 004353 191282







## Pharos

satin nickel  
metal/glass

### 1. HK13021S13 ⊕

‡ 1630mm ↔  
→ ø 400mm  
A60, E27, 1 x 60W

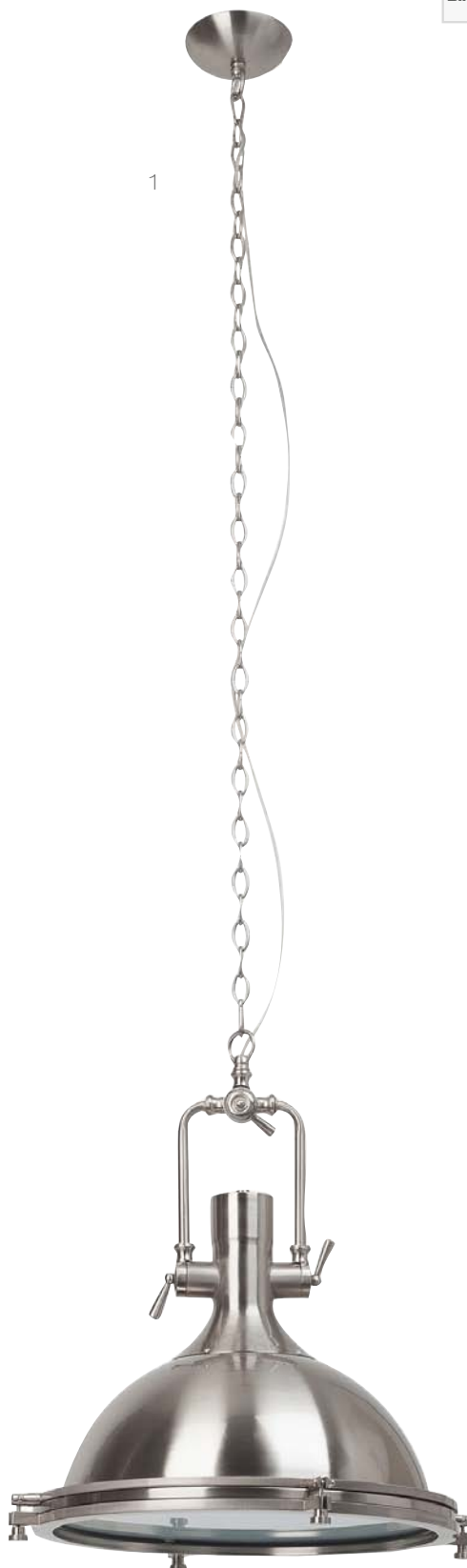

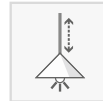

## Enzio

pewter  
metal

1.66472/43 

‡ 880 - 1100mm ↔ 1150mm  
→ 520mm ø  
D45, E14, 4 x 40W



1





## Gracian

brushed brass  
metal

1.93663/18 

↑ 1300mm ↔  
→ ∅ 250mm  
QT14, G9, 3 x 20W



1





1-2



1-2

## Wow

white  
metal

1. 93559/05

‡ 1350mm ↔  
→ ø 445mm  
A60, E27, 1 x 60W



4 004353 229121

1

## Horizont

grey  
metal

2. 93560/22

‡ 1200mm ↔  
→ ø 390mm  
A60, E27, 1 x 60W



4 004353 229138

2

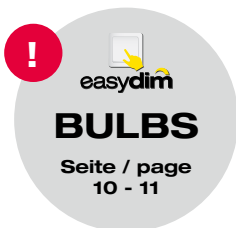



1-2

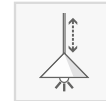

1-2

## Pure

black  
metal

1. 93557/06 

‡ 1200mm ↔  
→ ø 390mm  
A60, E27, 1 x 60W



4 004353 229107

## Silence

white  
metal/textil

2. 93558/05 

‡ 1240mm ↔  
→ ø 400mm  
A60, E27, 1 x 60W



4 004353 229114

2



**LED  
FILAMENT  
BULBS**

Seite / page  
326





1-2



1-2

## Ancolie

chrome/aluminium/copper metal

### 1. 93674/21

‡ 1200mm ↔  
→ ø 400mm  
A60, E27, 1 x 60W



### 2. 93674/29

‡ 1200mm ↔  
→ ø 400mm  
A60, E27, 1 x 60W





1-2



1-2

## Grace

bright nickel/copper metal

### 1. 93675/13

‡ 1200mm ↔  
→ ø 315mm  
A60, E27, 1 x 60W



4 004353 256554

### 2. 93675/29

‡ 1200mm ↔  
→ ø 315mm  
A60, E27, 1 x 60W



4 004353 256561







1



1

## Sid

copper/transparent  
glass/metal

### 1. 93676/29

‡ 1040mm ↔  
→ ø 300mm  
A60, E27, 1 x 60W



4 004353 256578

## LED Filament Bulbs

amber

### 2. 96694A10

Ambience E27  
‡ 140mm ↔  
→ ø 64mm  
4W, 400 lm, 2500K



4 004353 240515

### 3. 96704A10

Globe E27  
‡ 137mm ↔  
→ ø 95mm  
6W, 560 lm, 2500K



4 004353 264672

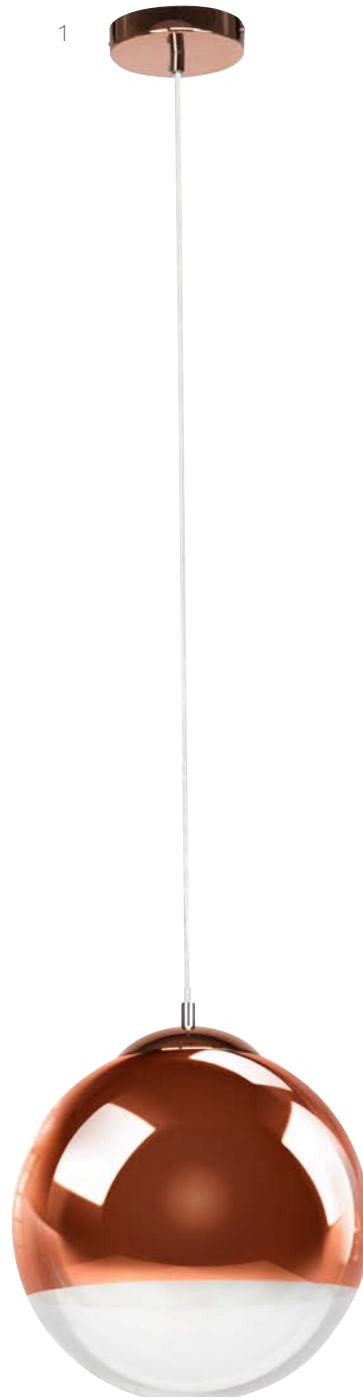

1

2



3





1-2



1-2

## Salford

black/copper/chrome  
metal/chrome

### 1. 93590/29

‡ 1160mm ↔  
→ ø 230mm  
A60, E27, 1 x 60W



4 004353 256530

### 2. 93590/76

‡ 1160mm ↔  
→ ø 230mm  
A60, E27, 1 x 60W



4 004353 256547

1



2

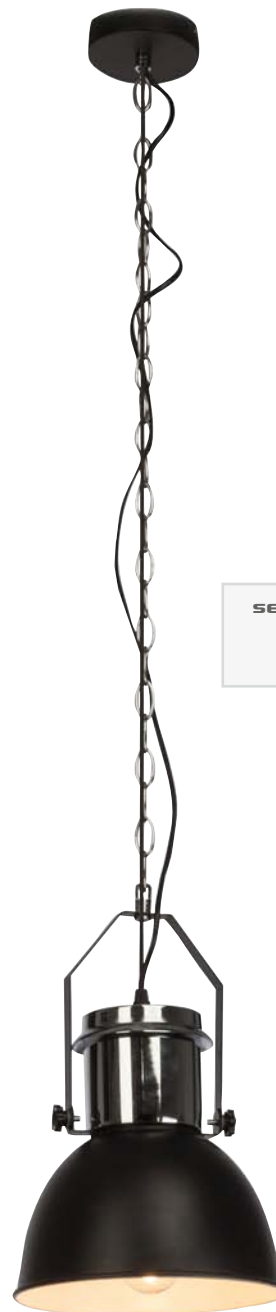

SEE OTHER COLOUR  
ON PAGE  
**332**

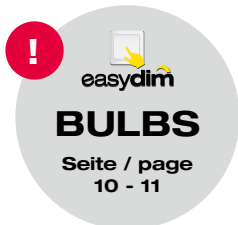



1-2



1-2

## Coppra

antique brass  
metal

1.93552/31 

‡ 1180mm ↔  
→ ø 40mm  
A60, E27, 1 x 60W



4 004353 219078

## Mayfair

black/copper  
metal

1.93460/76 

‡ 1000mm ↔  
→ ø 350mm  
A60, E27, 1 x 60W



4 004353 197192

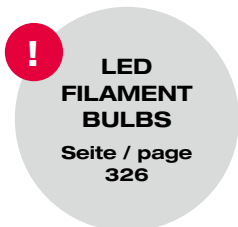

1



2

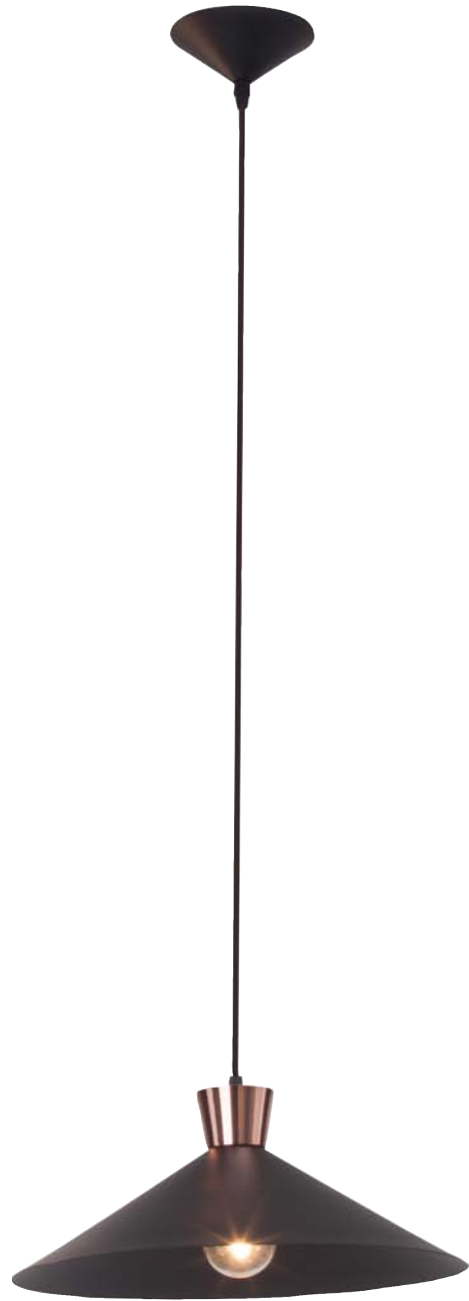



1-2



1-2

## Tycho

black/copper  
metal

1.93594/76

↑ 1490mm ↔ 250mm  
→ 250mm ø  
A60, E27, 1 x 60W



4 004353 240492

## Coriolis

black/copper  
metal

1.93595/76

↑ 1280mm ↔  
→ 50mm ø 245mm  
A60, E27, 1 x 60W



4 004353 240508

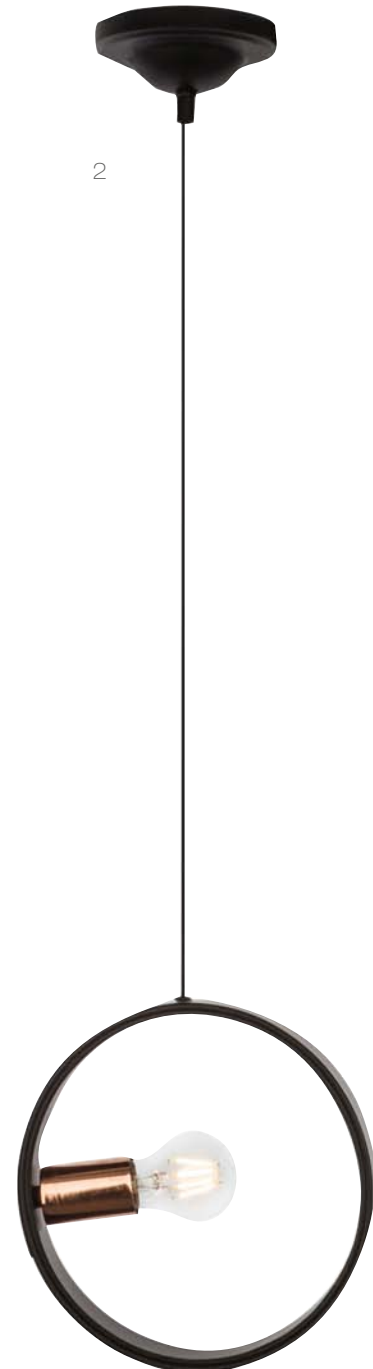
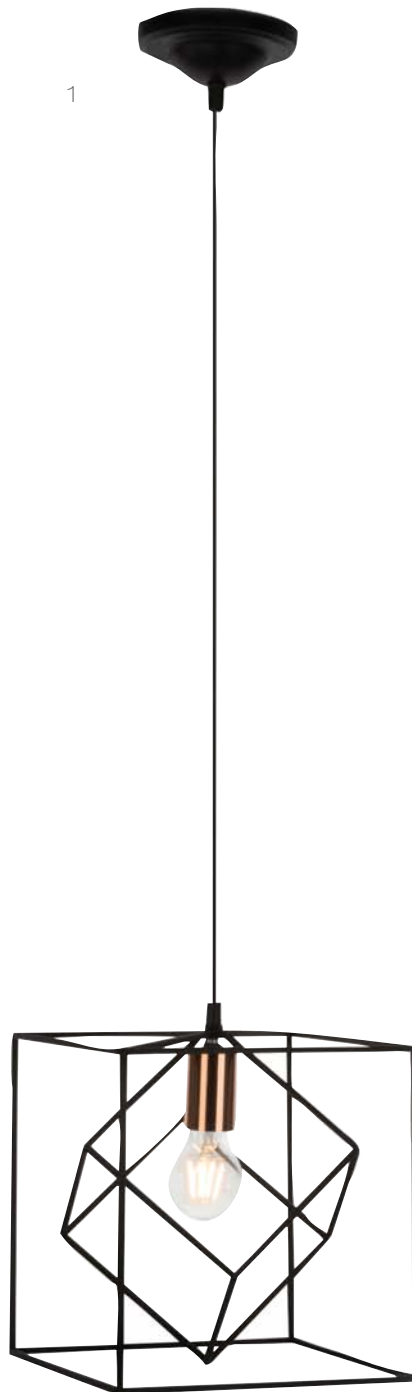

**LED  
FILAMENT  
BULBS**

Seite / page  
326



1-2



1-2

## Hippolyte

black/copper  
metal

1.93597/29 

↑ 1310mm ↔  
→ ∅ 255mm  
A60, E27, 1 x 60W



4 004353 241406

## Leonid

black  
metal

1.93601/06 

↑ 1340mm ↔  
→ ∅ 200mm  
A60, E27, 1 x 60W



4 004353 243615

2

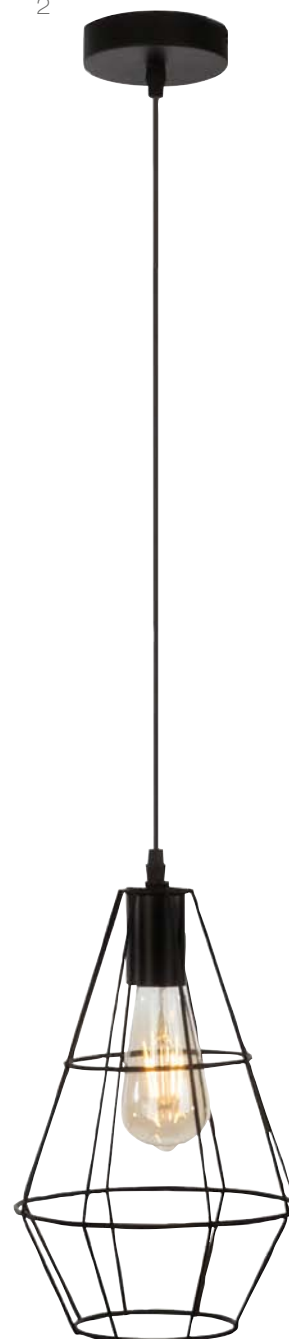
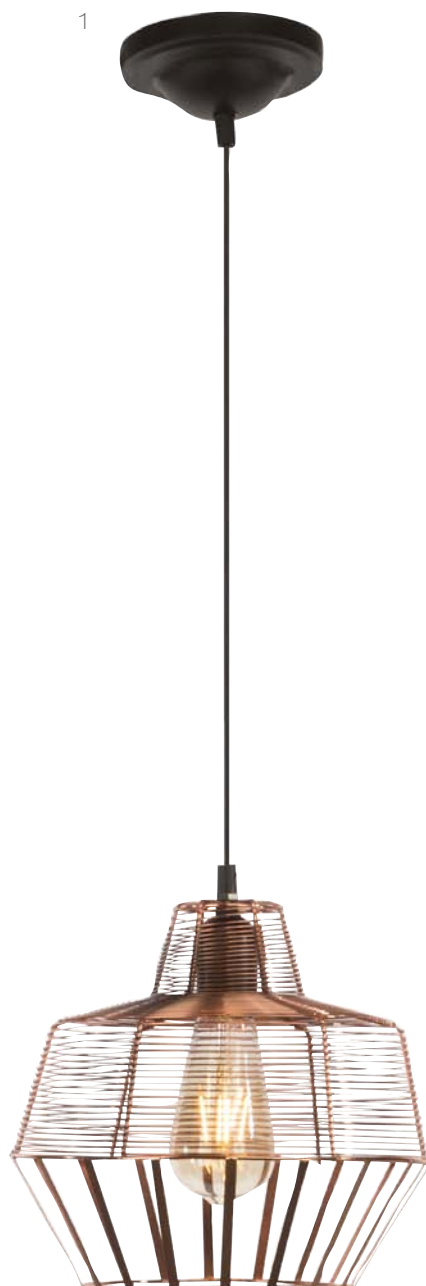

**LED  
FILAMENT  
BULBS**

Seite / page  
326



1-2



1-2

## Feodora

black/copper  
metal

1.93611/29 

↑ 1550mm ↔  
→ ∅ 300mm  
A60, E27, 1 x 60W



4 004353 246746

## Kago

black/copper  
metal

1.93612/29 

↑ 1470mm ↔ 180mm  
→ 180mm ∅  
A60, E27, 1 x 60W



4 004353 246753

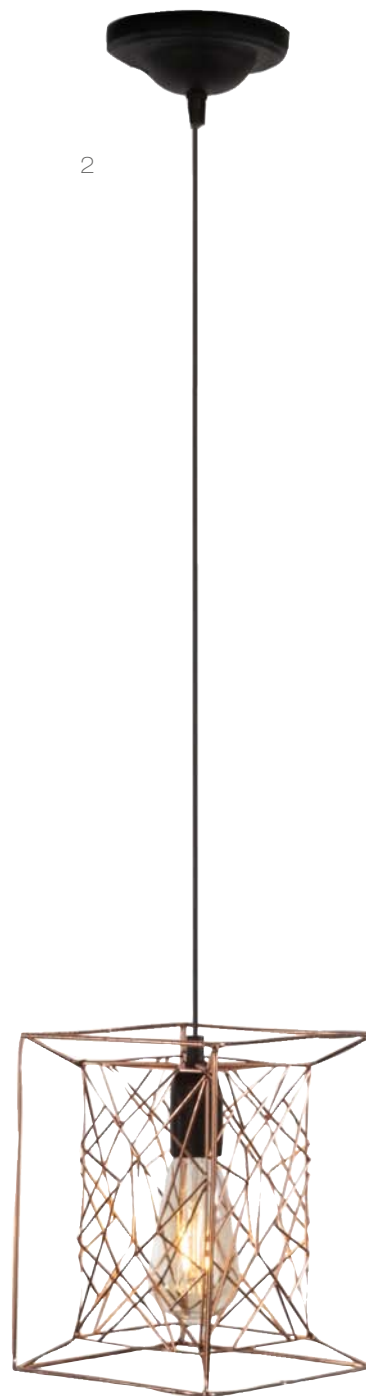
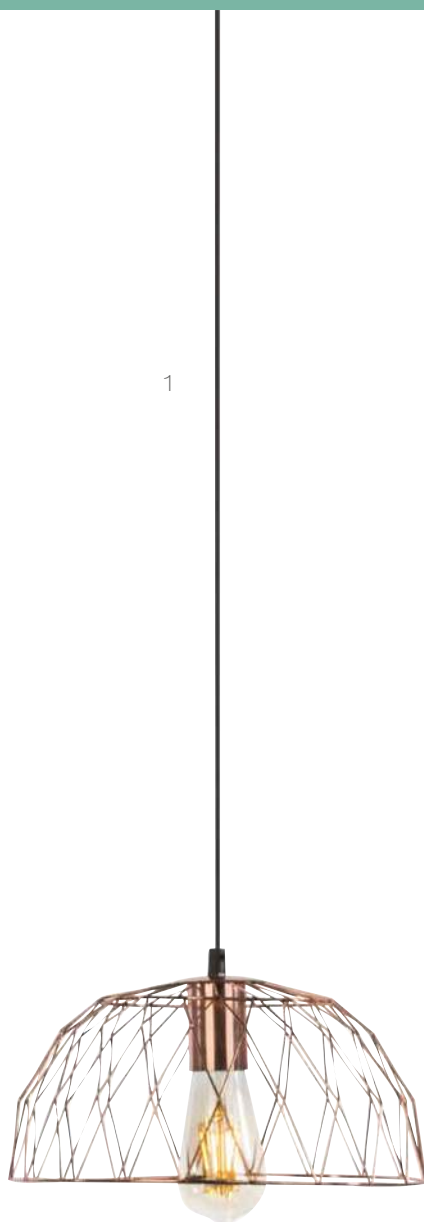



1-3

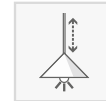

1-3

## Salford

cement finish  
metal

1. **93590/70** 

↓ 1160mm ↔  
→ ∅ 230mm  
A60, E27, 1 x 60W



4 004353 240454

## Grimsby

cement finish  
metal

2. **93589/70** 

↓ 1240mm ↔  
→ ∅ 305mm  
A60, E27, 1 x 60W



4 004353 240447

## Fleetwood

cement finish  
metal

3. **93588/70** 

↓ 1160mm ↔  
→ ∅ 365mm  
A60, E27, 1 x 60W



4 004353 240430



SEE OTHER COLOURS  
ON PAGE  
**327**

**!**  
**LED  
FILAMENT  
BULBS**  
Seite / page  
326



# PENDANTS





1-2



1-2

## Anouk

grey antique  
metal/glass

### 1. 93444/70

‡ 1300mm ↔  
→ ø 475mm  
A60, E27, 1 x 60W



### 2. F-93444/70

‡ 1550mm ↔  
→ ø 475mm  
A60, E27, 1 x 60W





1-2



1-2

## Salma

concrete grey  
metal

1. 93616/70

‡ 1370mm ↔  
→ ø 475mm  
A60, E27, 1 x 60W



1



## Bente

concrete grey  
metal

2. 93617/70

‡ 1270mm ↔  
→ ø 300mm  
A60, E27, 1 x 60W



2

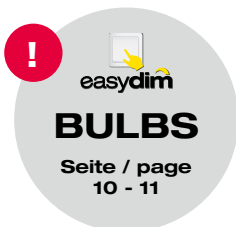
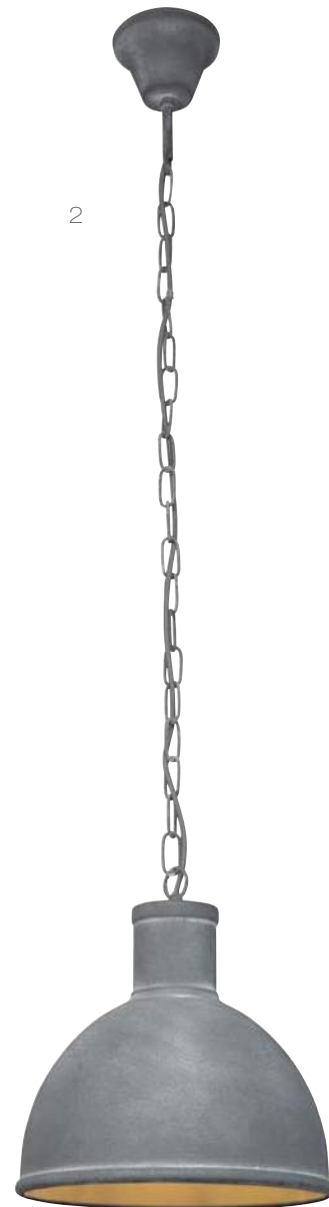



1-2

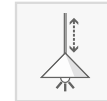

1-2

## Rope

concrete grey  
metal

1. 93614/70 

↓ 1310mm ↔  
→ ∅ 470mm  
A60, E27, 1 x 60W



## Torres

concrete grey  
metal

2. 93615/70 

↓ 1150mm ↔  
→ ∅ 365mm  
A60, E27, 1 x 60W



2



 **LED  
FILAMENT  
BULBS**  
Seite / page  
326

# PENDANTS







1-3



1-3

## Desert

yellow/blue/oak colour  
metal

### 1. 93618/02

↑ 1230mm ↔  
→ ∅ 350mm  
A60, E27, 1 x 60W



4 004353 246814

### 2. 93618/03

↑ 1230mm ↔  
→ ∅ 350mm  
A60, E27, 1 x 60W



4 004353 246821

### 3. 93618/72

↑ 1230mm ↔  
→ ∅ 350mm  
A60, E27, 1 x 60W



4 004353 246838

1



2



3



 **LED  
FILAMENT  
BULBS**  
Seite / page  
326



1-2



1-2

## Dirt

rust colour  
metal

### 1. 93613/74

↓ 1040mm ↔  
→ ∅ 350mm  
A60, E27, 1 x 40W



### 2. 93613/55

↓ 1000mm ↔  
→ ∅ 255mm  
A60, E27, 1 x 40W



1



2

**!**  
**LED  
FILAMENT  
BULBS**  
Seite / page  
326





1-2



1-2

## Frieda

concrete/black  
wood/metal

### 1. 93630/70

‡ 1400mm ↔  
→ ∅ 390mm  
A60, E27, 1 x 60W



### 2. 93668/76

‡ 1420mm ↔  
→ ∅ 480mm  
A60, E27, 1 x 60W

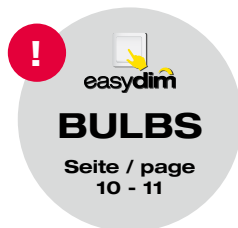

# PENDANTS



## Wooddesign

chrome/oak/white  
metal/wood/glass

### 1. 93659/35

‡ 1090mm ↔ 440mm  
→ 440mm ø  
D45, E27, 1 x 40W



### 2. 93660/35

‡ 1060mm ↔ 440mm  
→ 440mm ø  
A60, E27, 1 x 60W



1-2

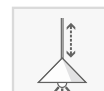

1-2



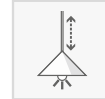

## Sherwood

oak/red/transparent  
wood/glass

1.93649/00 

± 1120mm ↔

→ ∅ 250mm

A60, E27, 1 x 60W

↗ 98310/00

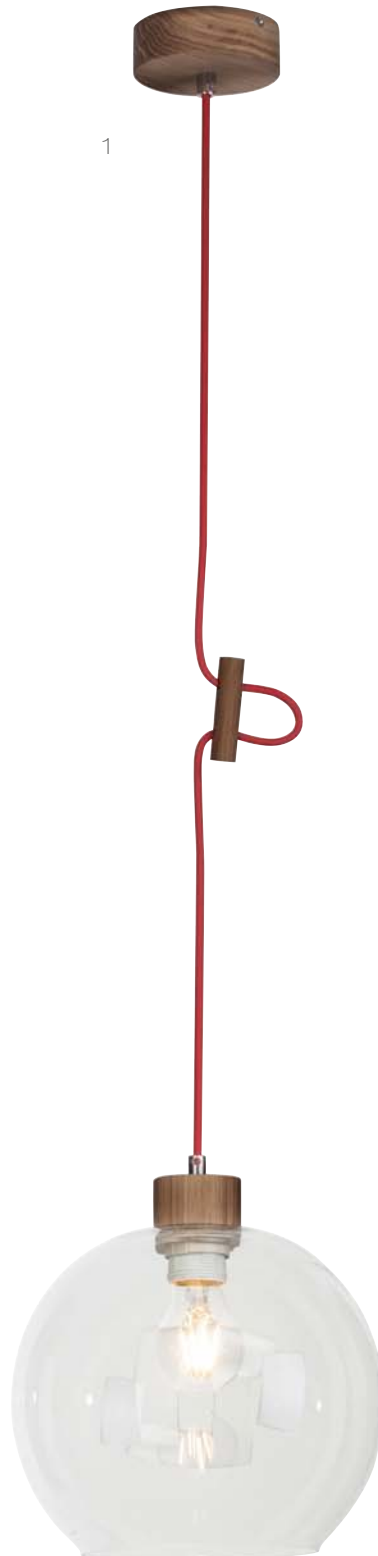



1-3



1-3

## Nature

oak/white  
wood/glass

### 1. 23073/35

‡ 900mm ↔  
→ ø 295mm  
A60, E27, 3 x 60W  
♣98262/05



4 004353 246661

### 2. 23070/35

‡ 1120mm ↔  
→ ø 100mm  
A60, E27, 1 x 60W  
♣98262/05



4 004353 246586

### 3. 23074/35

‡ 1030mm ↔ 750mm  
→ 100mm ø  
A60, E27, 4 x 60W  
♣98262/05



4 004353 246647

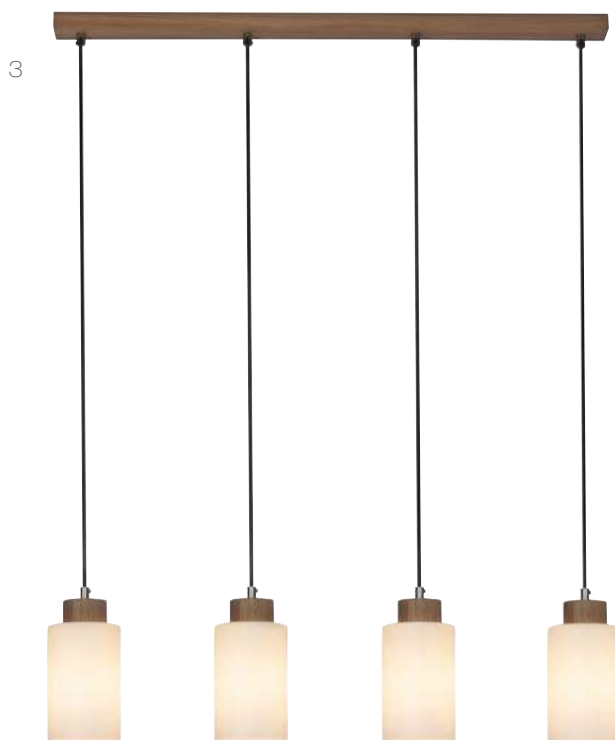

**!**  
easydim  
**BULBS**  
Seite / page  
10 - 11





1-3



1-3

## Nature

birch/white  
wood/glass

### 1. 23073/50

‡ 900mm ↔  
→ ø 295mm  
A60, E27, 3 x 60W  
♣98262/05



### 2. 23070/50

‡ 1120mm ↔  
→ ø 100mm  
A60, E27, 1 x 60W  
♣98262/05



### 3. 23074/50

‡ 1030mm ↔ 750mm  
→ 100mm ø  
A60, E27, 4 x 60W  
♣98262/05





1-2



1-2

## Bio

oak/birch/white  
wood/glass

### 1. 93610/35

↑ 730mm ↔  
→ ∅ 400mm  
A60, E27, 1 x 60W  
↗ 98263/05



4 004353 246401

### 2. 93610/50

↑ 730mm ↔  
→ ∅ 400mm  
A60, E27, 1 x 60W  
↗ 98263/05



4 004353 246418

1

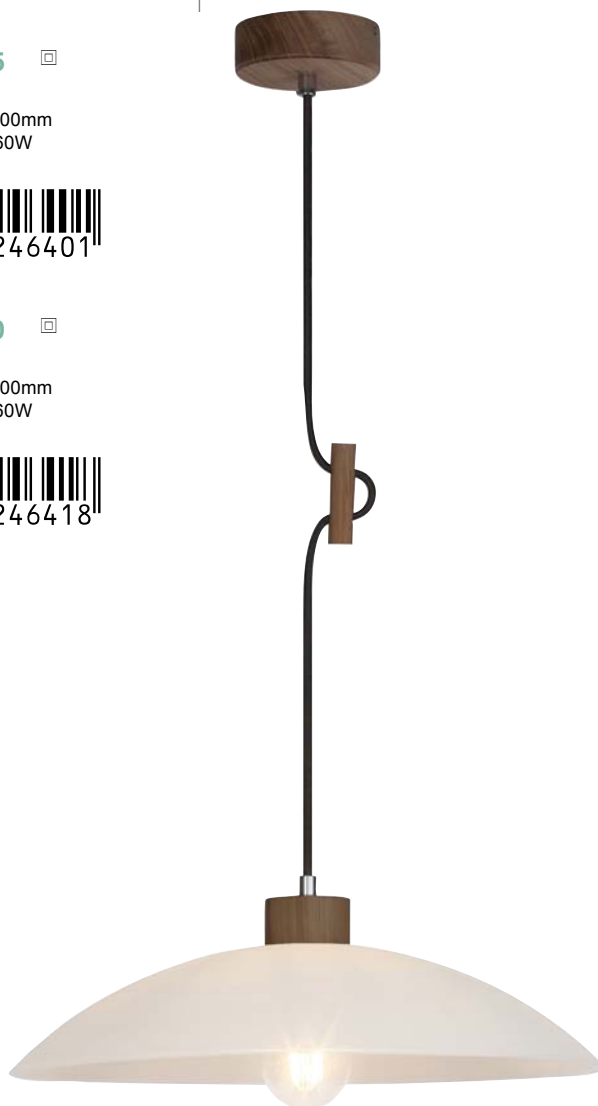

2







## Homely

wood light/white  
textile/wood/metal

1.93562/70 

↑ 880mm ↔ 900mm

→ 150mm ∅

A60, E27, 4 x 60W



4 004353 229169





1-2



1-2

## North

wood light/dark wood/white  
metal/wood

### 1. 93561/70

‡ 1030mm ↔  
→ ø 115mm  
A60, E27, 1 x 60W



4 004353 229145

### 2. 93561/75

‡ 1030mm ↔  
→ ø 115mm  
A60, E27, 1 x 60W



4 004353 229152





## Coppa

white/dark wood  
metal/wood

1.93546/05 

‡ 1100mm ↔

→ ø 220mm

A60, E27, 1 x 60W



4 004353 217920

1

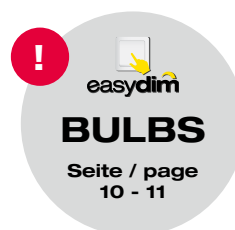
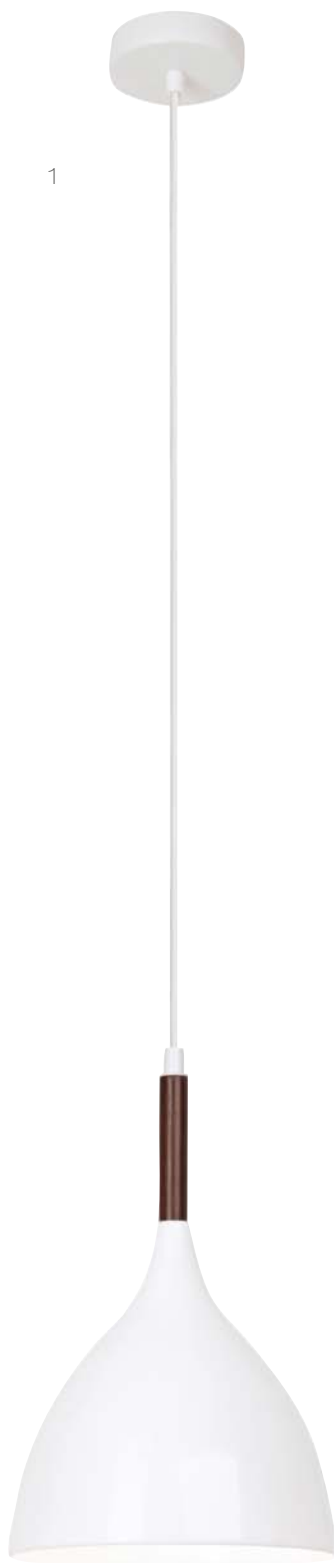



1 - 4

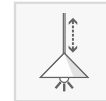

1 - 4

## Almira

white/black  
metal

### 1. 93388/05

‡ 1100mm ↔  
→ ø 235mm  
A60, E27, 1 x 60W



4 004353 154683

### 2. 93388/06

‡ 1100mm ↔  
→ ø 235mm  
A60, E27, 1 x 60W



4 004353 154690

## Ina

chrome/white/black  
metal

### 3. 07770/06

‡ 1100mm ↔  
→ ø 200mm  
A60, E27, 1 x 60W



4 004353 154898

### 4. 07770/05

‡ 1100mm ↔  
→ ø 200mm  
A60, E27, 1 x 60W



4 004353 154881



SEE OTHER VERSIONS  
ON PAGE  
**68 - 69**



1-5



1-5

## Tibo

shaped titan/titan red/titan white/  
titan/light brown  
metal/plastic

### 1. 76770/51

‡ 1250mm ↔  
→ ø255mm  
A60, E27, 1 x 75W



4 004353 000089

### 2. 76770/71

‡ 1250mm ↔  
→ ø255mm  
A60, E27, 1 x 75W



4 004353 000096

### 3. 76770/75

‡ 1250mm ↔  
→ ø255mm  
A60, E27, 1 x 75W



4 004353 000119

### 4. 76770/09

‡ 1250mm ↔  
→ ø255mm  
A60, E27, 1 x 75W



4 004353 106125

## Indy

chrome/transparent  
metal/plastic

### 5. 93250/00

‡ 1400mm ↔  
→ ø310mm  
A60, E27, 1 x 60W



4 004353 107696





1 - 4



1 - 4

## Freya

white/white alabaster  
plastic/glass

1. 93220/05 

↑ 1400mm ↔  
→ ø415mm  
A60, E27, 1 x 60W  
G95, E27, 1 x 60W



1

## Troja

silver/white/white pattern  
metal/glass

2. 93271/05 

↑ 1300mm ↔  
→ ø350mm  
A60, E27, 1 x 60W



2

## Ariana

satin nickel/alabaster  
glass/metal/plastic

3. 73578/13 

↑ 1400mm ↔  
→ ø380mm  
A60, E27, 1 x 100W



3

## Torbole

brass/white alabaster/beechn  
metal/wood/glass

4. 73678/72 

↑ 655-1530mm ↔  
→ ø 355mm  
A60, E27, 1 x 100W  
↗ 92270/94



4



1-3



1-3

## Erik

satin nickel/alabaster  
metal/glass

### 1. 70170/13

‡ 1400mm ↔  
→ ø135mm  
D45, E14, 1 x 40W  
↗91677/94



4 004353 047619

## Pastell

white/beechn  
glass/wood

### 2. 74270/05

‡ 1200mm ↔  
→ ø240mm  
A60, E27, 1 x 75W  
↗91753/91



4 004353 885617

## Bistro

black/titanium  
metal/plastic

### 3. 11170/11

‡ 1200mm ↔  
→ ø250mm  
A60, E27, 1 x 75W



4 004353 967467







1-6

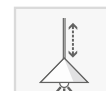

1-6

## Logo

silver/green/violet/red/  
white/torquoise/titanium  
metal/plastic

### 1. 78270/04

↓ 1240mm ↔  
→ ø 350mm  
A60, E27, 1 x 60W



4 004353 134692

### 2. 78270/78

↓ 1240mm ↔  
→ ø 350mm  
A60, E27, 1 x 60W



4 004353 134708

### 3. 78270/01

↓ 1240mm ↔  
→ ø 350mm  
A60, E27, 1 x 60W



4 004353 149276

### 4. 78270/05

↓ 1240mm ↔  
→ ø 350mm  
A60, E27, 1 x 60W



4 004353 020278

### 5. 78270/73

↓ 1240mm ↔  
→ ø 350mm  
A60, E27, 1 x 60W



4 004353 149290

### 6. 78270/11

↓ 1240mm ↔  
→ ø 350mm  
A60, E27, 1 x 60W



4 004353 020285





## Chris

white  
metal/plastic

1.56478/05 

‡ 600-1400mm ↔  
→ ø 340mm  
A60, E27, 1 x 75W



1

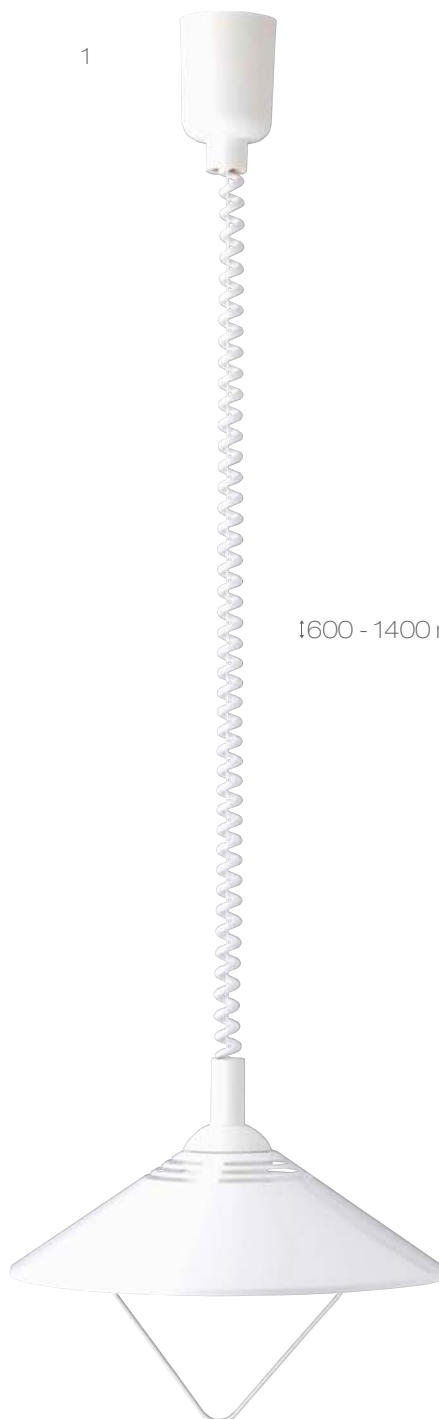

!600 - 1400 mm



1 - 4



1 - 4

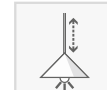

1 - 4

## Osaka

yellow/orange/blue/white  
metal/paper

### 1. 71170A02

↑            ↔  
→            ∅ 400mm  
A60, E27, 1 x 60W



4 004353 034220

### 2. 71170A07

↑            ↔  
→            ∅ 400mm  
A60, E27, 1 x 60W



4 004353 038327

### 3. 71170A03

↑            ↔  
→            ∅ 400mm  
A60, E27, 1 x 60W



4 004353 055966

### 4. 71170A05

↑            ↔  
→            ∅ 400mm  
A60, E27, 1 x 60W



4 004353 905742





1-5



1



1-5

## Rainbow

blue  
metal/paper

1. 73370A03

↓ 1600mm ↔  
→ ø370mm  
A60, E27, 1 x 60W



4 004353 905711

## Ika

blue  
wood

2. 70970/70

↓ 910mm ↔300mm  
→ ø  
A60, E27, 1 x 60W



4 004353 591211

## Schnurpendel

white  
metal/plastic

3. 93379/05

↓ 1200mm ↔  
→ ø  
A60, E27, 1 x 60W



4 004353 150456

4. 93327/05

↓ 800mm ↔  
→ ø  
A60, E27, 1 x 60W



4 004353 129629

5. 93327/06

↓ 800mm ↔  
→ ø  
A60, E27, 1 x 60W



4 004353 129636







# WALL & CEILING



1-3



1-3

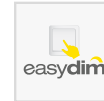

1-3

## Pluto

satin nickel/white metal/acrylic

### 1. G30586/13

↑ 105mm ↔ 780mm  
→ 350mm ø  
LED integr., 6 x 5W   
6 x 500 lm, 3000 K, **A+**



3000 LUMEN

### 2. G30596/13

↑ 105mm ↔  
→ ø 600mm  
LED integr., 6 x 5W   
6 x 500 lm, 3000 K, **A+**



3000 LUMEN

## Uranus

satin nickel/white metal/acrylic

### 3. G33896/13

↑ 105mm ↔ 780mm  
→ 350mm ø  
LED integr., 6 x 5W   
6 x 500 lm, 3000 K, **A+**



3000 LUMEN

SEE OTHER VERSIONS  
ON PAGE  
**14-15, 480**

SEE OTHER VERSIONS  
ON PAGE  
**16-18**





WALL & CEILING





1-4



1-4

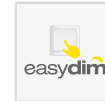

4

## Magellan

chrome/white  
metal/acrylic

### 1. G29091/15

‡ 35mm ↔ 110mm  
→ 110mm ø  
LED integr., 1 x 5W   
1 x 500 lm, 3000 K, **A+**



4 004353 248849



500  
LUMEN

### 2. G29092/15

‡ 40mm ↔ 280mm  
→ 110mm ø  
LED integr., 2 x 5W   
2 x 500 lm, 3000 K, **A+**



4 004353 248856



1000  
LUMEN

### 3. G29093/15

‡ 40mm ↔ 400mm  
→ 110mm ø  
LED integr., 3 x 5W   
3 x 500 lm, 3000 K, **A+**



4 004353 248863



1500  
LUMEN

### 4. G29094/15

‡ 40mm ↔ 300mm  
→ 300mm ø  
LED integr., 4 x 5W   
4 x 500 lm, 3000 K, **A+**



4 004353 248870



2000  
LUMEN



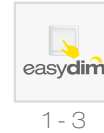

## Neptun

chrome/white  
metal/acrylic

### 1. G94487/15

↑ 45mm ↔  
→ ø 300mm  
LED integr., 1 x 20W   
1 x 2000 lm, 3000 K, **A+**



### 2. G94486/15

↑ 45mm ↔ 300mm  
→ 300mm ø  
LED integr., 1 x 20W   
1 x 2000 lm, 3000 K, **A+**



### 3. G94485/15

↑ 45mm ↔ 400mm  
→ 200mm ø  
LED integr., 1 x 20W   
1 x 2000 lm, 3000 K, **A+**



**LED**  
incl.

1 - 4

**easydim**

3 - 4

## Ceres

satin nickel/white  
metal/acrylic

### 1. G94460/13

↑ 40mm ↔  
→ ø 250mm  
LED integr., 1 x 10W   
1 x 1000 lm, 3000 K, **A+**



**1000**  
LUMEN

### 2. G94460/05

↑ 40mm ↔  
→ ø 250mm  
LED integr., 1 x 10W   
1 x 1000 lm, 3000 K, **A+**



**1000**  
LUMEN

### 3. G94461/13

↑ 40mm ↔  
→ ø 350mm  
LED integr., 1 x 20W   
1 x 2000 lm, 3000 K, **A+**



**easydim**

**2000**  
LUMEN



### 4. G94461/05

↑ 40mm ↔  
→ ø 350mm  
LED integr., 1 x 20W   
1 x 2000 lm, 3000 K, **A+**



**easydim**

**2000**  
LUMEN





1-2

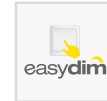

1-2

## Ceres

satin nickel/white  
metal/acrylic

### 1. G94498/13

↑ 40mm ↔  
→ ø 450mm  
LED integr., 1 x 30W   
1 x 3000 lm, 3000 K, **A+**



### 2. G94498/05

↑ 40mm ↔  
→ ø 450mm  
LED integr., 1 x 30W   
1 x 3000 lm, 3000 K, **A+**





1 - 4

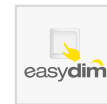



3 - 4

## Ceres

satin nickel/white metal/acrylic

### 1. G94462/05

↑ 40mm ↔ 250mm  
→ 250mm ø

LED integr., 1 x 10W   
1 x 1000 lm, 3000 K, 



4 004353 248788



1



1000 LUMEN

### 2. G94462/13

↑ 40mm ↔ 250mm  
→ 250mm ø

LED integr., 1 x 10W   
1 x 1000 lm, 3000 K, 



4 004353 248795



2



1000 LUMEN

### 3. G94463/05

↑ 40mm ↔ 450mm  
→ 450mm ø

LED integr., 1 x 30W   
1 x 3000 lm, 3000 K, 



4 004353 248801



3



3000 LUMEN

### 4. G94463/13

↑ 40mm ↔ 450mm  
→ 450mm ø

LED integr., 1 x 30W   
1 x 3000 lm, 3000 K, 



4 004353 248818

4



3000 LUMEN



**LED**  
incl.

1 - 4

**easydim**

1 - 4

## Ceres

satin nickel/white  
metal/acrylic

### 1. G94493/13

‡ 40mm ↔ 350mm  
→ 350mm ø  
LED integr., 1 x 20W   
1 x 2000 lm, 3000 K, **A+**



**easydim** **2000 LUMEN**

### 2. G94493/05

‡ 40mm ↔ 350mm  
→ 350mm ø  
LED integr., 1 x 20W   
1 x 2000 lm, 3000 K, **A+**



**easydim** **2000 LUMEN**

### 3. G94464/13

‡ 40mm ↔ 450mm  
→ 200mm ø  
LED integr., 1 x 20W   
1 x 2000 lm, 3000 K, **A+**



**easydim** **2000 LUMEN**

### 4. G94464/05

‡ 40mm ↔ 450mm  
→ 200mm ø  
LED integr., 1 x 20W   
1 x 2000 lm, 3000 K, **A+**



**easydim** **2000 LUMEN**





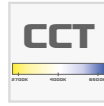

## Smooth

satin nickel/white metal/plastic

### 1. G20880/05

↑ 55mm ↔  
→ ø 300mm  
LED integr., 1 x 24W   
1 x 1900 lm, 2700-6500 K,   
↗ 98359/00, 98204/05



### 2. G20881/13

↑ 55mm ↔  
→ ø 400mm  
LED integr., 1 x 30W   
1 x 2300 lm, 2700-6500 K,   
↗ 98358/00, 98204/05



### 3. G20882/05

↑ 55mm ↔  
→ ø 500mm  
LED integr., 1 x 36W   
1 x 2800 lm, 2700-6500 K,   
↗ 98361/00, 98204/05



### 4. G20883/13

↑ 55mm ↔  
→ ø 600mm  
LED integr., 1 x 46W   
1 x 3800 lm, 2700-6500 K,   
↗ 98361/00, 98204/05



SEE OTHER VERSIONS  
ON PAGE  
**288 - 289**





1-4

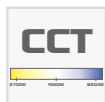

1-4



1-4



1-4

## Smooth

satin nickel/white  
metal/plastic

### 1. G20884/13

‡ 55mm ↔ 300mm  
→ 300mm ø  
LED integr., 1 x 24W   
1 x 1850 lm, 2700-6500 K,   
↗ 98359/00, 98204/05



4 004353 239991



satin nickel only

1850  
LUMEN



white only

2500  
LUMEN

### 2. G20885/05

‡ 55mm ↔ 400mm  
→ 400mm ø  
LED integr., 1 x 32W   
1 x 2500 lm, 2700-6500 K,   
↗ 98359/00, 98204/05



4 004353 240003

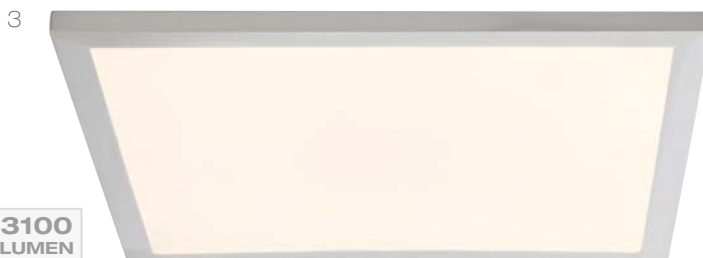

3100  
LUMEN

satin nickel only

### 3. G20886/13

‡ 55mm ↔ 500mm  
→ 500mm ø  
LED integr., 1 x 42W   
1 x 3100 lm, 2700-6500 K,   
↗ 98360/00, 98204/05



4 004353 240010



XXL  
FORMAT  
600 MM

white only

3600  
LUMEN

### 4. G20887/05

‡ 55mm ↔ 600mm  
→ 600mm ø  
LED integr., 1 x 46W   
1 x 3600 lm, 2700-6500 K,   
↗ 98361/00, 98204/05



4 004353 240027



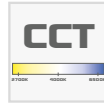



## Smooth

white  
metal/acrylic

### 1. G20888/05

↑ 55mm ↔900mm  
→ ø 150mm

LED integr., 1 x 30W 

1 x 2350 lm, 2700-6200 K, 

↗ 98358/00, 98204/05



4 004353 240034



2350  
LUMEN



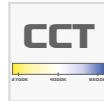

## Flat

aluminium/white metal/acrylic

### 1. G94395/05

↑ 55mm ↔ 420mm  
→ 420mm ø  
LED integr., 1 x 32W   
1 x 2500 lm, 2700-6500 K,   
98204/05, 98223/00



2500 LUMEN

### 2. G94396/05

↑ 55mm ↔ 600mm  
→ 600mm ø  
LED integr., 1 x 42W   
1 x 3310 lm, 2700-6500 K,   
98204/05, 98224/00



3310 LUMEN

### 3. G94397/05

↑ 55mm ↔ 1000mm  
→ 350mm ø  
LED integr., 1 x 60W   
1 x 5000 lm, 2700-6500 K,   
98204/05, 98225/00



5000 LUMEN



**LED**  
incl.

1 - 4

## Katalina

white  
metal/plastic

### 1. G94258/05

↑ 40mm ↔  
→ ø 225mm  
LED integr., 1 x 18W   
1 x 1470 lm, 3000 K, **A**



1



**1470**  
LUMEN

### 2. G94259/05

↑ 40mm ↔  
→ ø 295mm  
LED integr., 1 x 24W   
1 x 1910 lm, 3000 K, **A**



2



**1910**  
LUMEN

## Jarno

white  
metal/plastic

### 3. G94256/05

↑ 40mm ↔ 230mm  
→ 230mm ø  
LED integr., 1 x 18W   
1 x 1510 lm, 3000 K, **A**



3

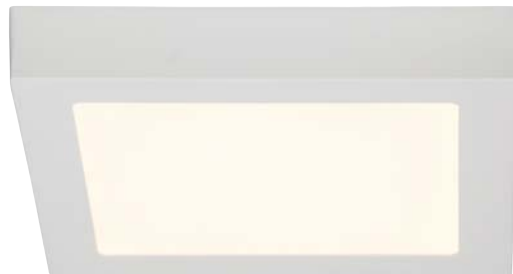

**1510**  
LUMEN

### 4. G94257/05

↑ 40mm ↔ 300mm  
→ 300mm ø  
LED integr., 1 x 24W   
1 x 1850 lm, 3000 K, **A**



4



**1850**  
LUMEN



1-3



3



3

## Babett

white  
metal/glass

### 1. G94254/05

‡ 75mm ↔ 120mm  
→ 120mm ø  
LED integr., 1 x 10W   
1 x 770 lm, 3000 K, **A**



4 004353 198021

1



770  
LUMEN

### 2. G94255/05

‡ 80mm ↔ 200mm  
→ 200mm ø  
LED integr., 1 x 20W   
1 x 1520 lm, 3000 K, **A**



4 004353 198038

2



1520  
LUMEN

## Tizian

white  
metal / plastic

### 3. G94252/05

‡ 70mm ↔  
→ ø 300mm  
LED integr., 1 x 22W   
1 x 1675 lm, 3000 K, **A**



4 004353 198007

3

1675  
LUMEN





1-5



1-5

## Doors Round

chrome  
metal/acrylic

### 1. G19191/15

‡ 180mm ↔ 180mm  
→ 100mm ø  
LED integr., 1 x 9W   
1 x 630 lm, 3000 K, **A**



4 004353 239212



### 2. G19192/15

‡ 100mm ↔ 430mm  
→ 180mm ø  
LED integr., 2 x 9W   
2 x 630 lm, 3000 K, **A**



4 004353 239229



### 3. G19195/15

‡ 100mm ↔ 510mm  
→ 510mm ø  
LED integr., 5 x 9W   
5 x 630 lm, 3000 K, **A**  
98345/00



4 004353 239250



### 4. G19193/15

‡ 100mm ↔ 670mm  
→ 180mm ø  
LED integr., 3 x 9W   
3 x 630 lm, 3000 K, **A**



4 004353 239236



### 5. G19194/15

‡ 100mm ↔ 910mm  
→ 180mm ø  
LED integr., 4 x 9W   
4 x 630 lm, 3000 K, **A**  
98344/00



4 004353 239243





1-5



1-5

## Doors Square

satin nickel  
metal/acrylic

### 1. G16291/13

‡ 180mm ↔ 180mm  
→ 100mm ø  
LED integr., 1 x 9W   
1 x 630 lm, 3000 K, **A**



4 004353 232855



### 2. G16292/13

‡ 100mm ↔ 430mm  
→ 180mm ø  
LED integr., 2 x 9W   
2 x 630 lm, 3000 K, **A**



4 004353 232862



### 3. G16295/13

‡ 100mm ↔ 510mm  
→ 510mm ø  
LED integr., 5 x 9W   
5 x 630 lm, 3000 K, **A**  
98345/00



4 004353 232893



### 4. G16293/13

‡ 100mm ↔ 670mm  
→ 180mm ø  
LED integr., 3 x 9W   
3 x 630 lm, 3000 K, **A**



4 004353 232879



### 5. G16294/13

‡ 100mm ↔ 910mm  
→ 180mm ø  
LED integr., 4 x 9W   
4 x 630 lm, 3000 K, **A**  
98344/00



4 004353 232886







1 - 4



1 - 4

## Samurai

satin nickel  
metal/acrylic

### 1. G15591/13

‡ 60mm ↔ 600mm  
→ 160mm ø  
LED integr., 1 x 14W   
1 x 980 lm, 3000 K, **A**



4 004353 232817



### 2. G15592/13

‡ 60mm ↔ 920mm  
→ 160mm ø  
LED integr., 2 x 15W   
1 x 2200 lm, 3000 K, **A**  
↗98341/00



4 004353 232824



### 3. G15593/13

‡ 60mm ↔ 870mm  
→ 195mm ø  
LED integr., 3 x 15W   
1 x 3290 lm, 3000 K, **A**  
↗98342/00



4 004353 232831



### 4. G15594/13

‡ 60mm ↔ 890mm  
→ 270mm ø  
LED integr., 4 x 14W   
1 x 4095 lm, 3000 K, **A**  
↗98343/00



4 004353 232848



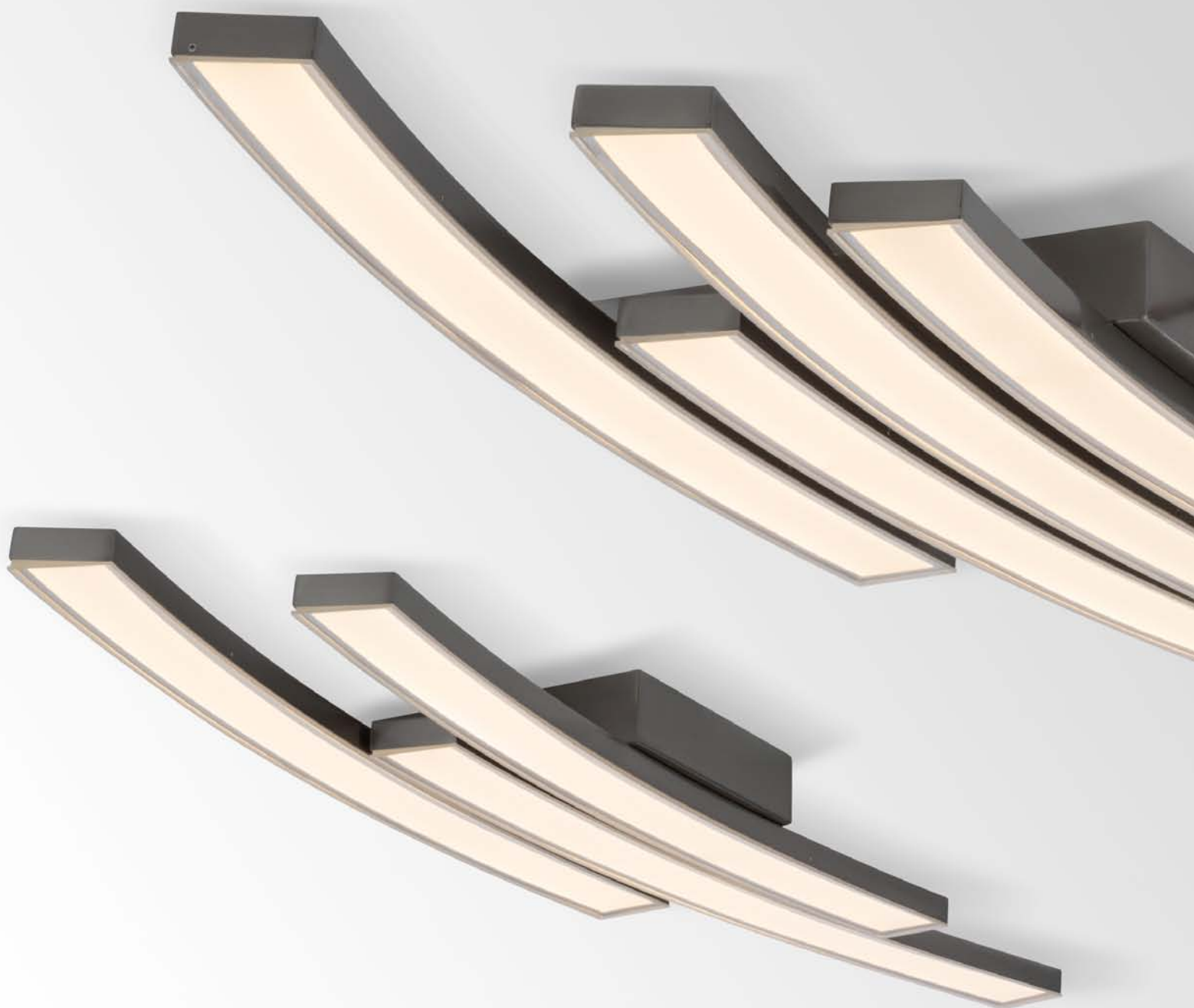





## Topic

chrome  
metal/acrylic

### 1. G94322/15

↑ 240mm ↔ 720mm  
→ 720mm ∅

LED integr., 1 x 25W 

1 x 2400 lm, 3000 K, 

↗ 98144/00



2400  
LUMEN





## Eternity

chrome  
metal/acrylic

### 1. G94472/15

± 92mm ↔ 462mm  
→ 466mm ø  
LED integr, 1 x 26,2W   
1 x 2495 lm, 3000 K, **A+**



1



2495  
LUMEN





1-3



3



1-3

## Vogue

chrome  
metal/glass

### 1. G33991/15

‡ 127mm ↔ 260mm  
→ 130mm ø  
LED integr., 1 x 6W   
1 x 370 lm, 3000 K, **A**   
98322/00



4 004353 249624



370  
LUMEN

### 2. G33993/15

‡ 116mm ↔ 603mm  
→ 260mm ø  
LED integr., 3 x 6W   
3 x 370 lm, 3000 K, **A**   
98322/00



4 004353 249631



1110  
LUMEN

### 3. G33995/15

‡ 118mm ↔ 1062mm  
→ 279mm ø  
LED integr., 5 x 6W   
5 x 370 lm, 3000 K, **A**   
98322/00



4 004353 249648



1850  
LUMEN





## New Design

chrome  
metal/glass

### 1. G94333/15

± 160mm ↔ 550mm

→ 180mm ø

LED integr., 6 x 4,8W 

6 x 390 lm, 3000 K, 



4 004353 205996

1



2340  
LUMEN





## Picture

chrome  
metal/acrylic

### 1. G94394/15

↑ 1210mm ↔ 215mm  
→ 600mm ø

LED integr., 2 x 11W   
2 x 400 lm, 3000 K,



4 004353 216626

800  
LUMEN





1-2



1

## Traffic

chrome/white  
metal/acrylic

### 1. G94490/15

↑ 135mm ↔  
→ 475mm ø 536mm  
LED integr., 1 x 17,7W   
1 x 1640 lm, 3000 K, **A+**



4 004353 251504

1



1640  
LUMEN

## Venti

satin nickel/white  
metal/acrylic

### 2. G94402/13

↑ 85mm ↔  
→ ø 800mm  
LED integr., 6 x 4W   
6 x 330 lm, 3000 K, **A+**  
/98399/00



4 004353 216961

2



1980  
LUMEN





**LED**  
incl.

1-3

## Block

chrome/white  
metal/acrylic

### 1. G94455/15

‡ 163mm ↔ 159mm  
→ 56mm ø  
LED integr., 2 x 3W   
2 x 300 lm, 3000 K, **A++**

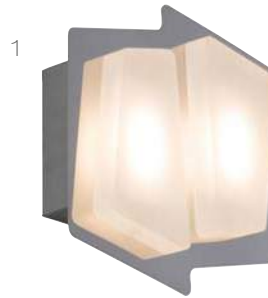

**600**  
LUMEN

### 2. G94456/15

‡ 56mm ↔ 303mm  
→ 158mm ø  
LED integr., 4 x 3W   
4 x 300 lm, 3000 K, **A++**



**1200**  
LUMEN

### 3. G94457/15

‡ 56mm ↔ 443mm  
→ 158mm ø  
LED integr., 6 x 3W   
6 x 300 lm, 3000 K, **A++**



**1800**  
LUMEN



**LED**  
incl.  
1-2

## Vision

chrome/white  
metal/acrylic

### 1. G94326/15

‡ 190mm ↔ 155mm  
→ 43mm ø  
LED integr., 1 x 4,6W   
1 x 322 lm, 3000 K, **A+**



**322**  
LUMEN

## Together

chrome/white  
metal/acrylic

### 2. G94489/15

‡ 80mm ↔ 930mm  
→ 126mm ø  
LED integr., 1 x 22,1W   
1 x 1730 lm, 3000 K, **A**  
#98319/00



**1730**  
LUMEN



**LED**  
incl.

## Wrap

chrome/white  
metal/acrylic

### 1. G93543/15

± 150mm ↔ 225mm  
→ 160mm ø

LED integr., 1 x 6,5W   
1 x 455 lm, 3000 K, **A+**

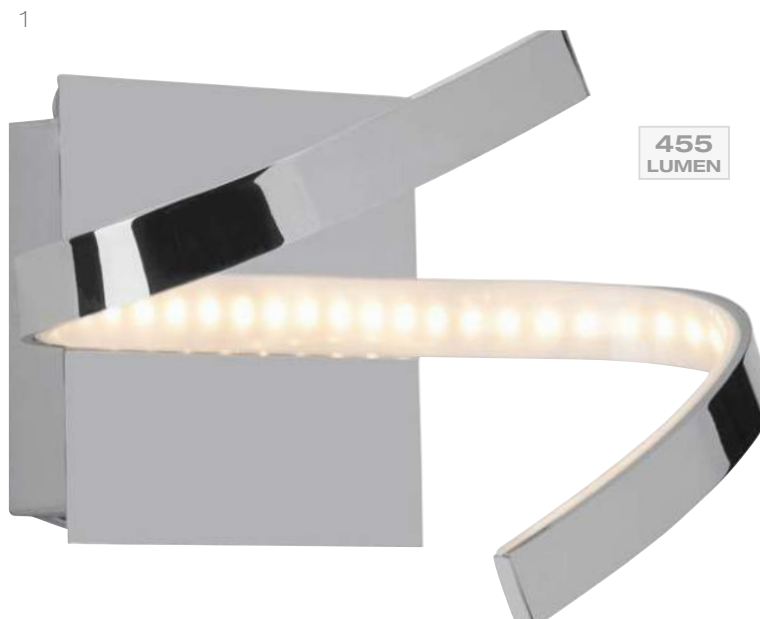

**LED**  
incl.

## Way

chrome/white  
metal/acrylic

### 1. G94324/13

↑ 50mm ↔ 995mm

→ 90mm ø

LED integr., 1 x 21W 

1 x 1830 lm, 3100 K, 

↗ 98364/00



1830  
LUMEN

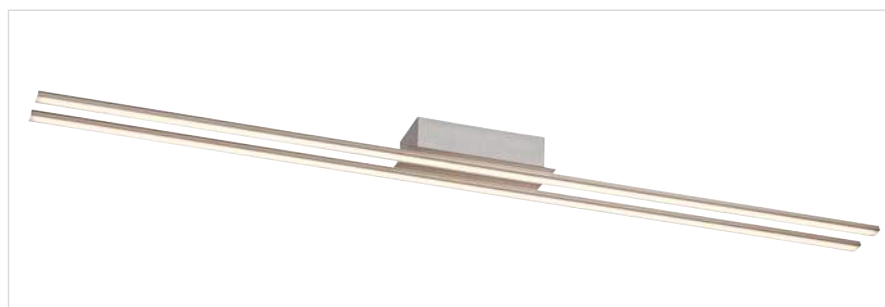

**LED**  
incl.

1-2

## Saturn

chrome  
metal/plastic

### 1. G94245/15

‡ 400mm ↔  
→ 670mm ø 450mm  
LED integr., 1 x 26W   
1 x 2250 lm, 3000 K, **A+**  
/98335/00



## Yunan

chrome  
metal/plastic

### 2. G94348/15

‡ 290mm ↔  
→ ø 480mm  
LED integr., 1 x 42W   
1 x 3875 lm, 3000 K, **A+**



WALL & CEILING





## Dajana

chrome/aluminium  
metal/aluminium

### 1. G94343/77

‡ 355mm ↔ 700mm  
→ 220mm ø  
LED integr., 5 x 5W   
5 x 400lm, 3000 K, **A+**   
/98208/15



**LED**  
incl.

1-2

## Jaimie

satin nickel  
metal/plastic

### 1. G94417/13

↑ 330mm ↔  
→ ø 720mm  
LED integr., 1 x 12W   
1 x 850 lm, 3000 K, **A**



**850**  
LUMEN

## Fair

satin nickel  
metal/plastic

### 2. G94473/13

↑ 97mm ↔ 475mm  
→ 475mm ø  
LED integr., 4 x 4W   
4 x 320 lm, 3000 K, **A+**



**1280**  
LUMEN





## Loop

satin nickel  
metal/plastic

1. G94482/13 

↑ 255mm ↔

→ ∅ 465mm

LED integr, 1 x 22,6W 

1 x 1995 lm, 3000 K, 



WALL & CEILING





1-3



1-3



1-3

## Fashion Round

satin nickel/white  
metal/glass

### 1. G16991/13

‡ 270mm ↔ 245mm  
→ 300mm ø  
LED integr., 1 x 5W  
1 x 300 lm, 3000 K  
98206/98



4 004353 232954

1



300  
LUMEN

### 2. G16993/13

‡ 280mm ↔ 560mm  
→ 170mm ø  
LED integr., 3 x 5W  
3 x 300 lm, 3000 K  
98206/98, 98346/00



4 004353 232961

2



900  
LUMEN



### 3. G16995/13

‡ 265mm ↔ 990mm  
→ 200mm ø  
LED integr., 5 x 5W  
5 x 300 lm, 3000 K  
98206/98, 98347/00



4 004353 232978

3



1500  
LUMEN





1-3



1-3



1-3

## Fashion Square

satin nickel/white  
metal/glass

### 1. G16891/13

↑ 265mm ↔ 245mm  
→ 320mm ø  
LED integr., 1 x 5W  
1 x 300 lm, 3000 K  
98205/98



4 004353 232909

### 2. G16893/13

↑ 270mm ↔ 640mm  
→ 170mm ø  
LED integr., 3 x 5W  
3 x 300 lm, 3000 K  
98205/98, 98346/00



4 004353 232916

### 3. G16895/13

↑ 220mm ↔ 980mm  
→ 170mm ø  
LED integr., 5 x 5W  
5 x 300 lm, 3000 K  
98205/98, 98347/00



4 004353 232923



300  
LUMEN

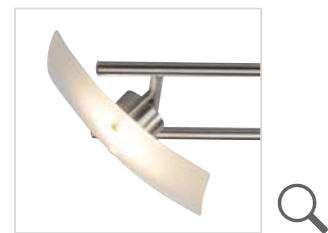

900  
LUMEN



1500  
LUMEN

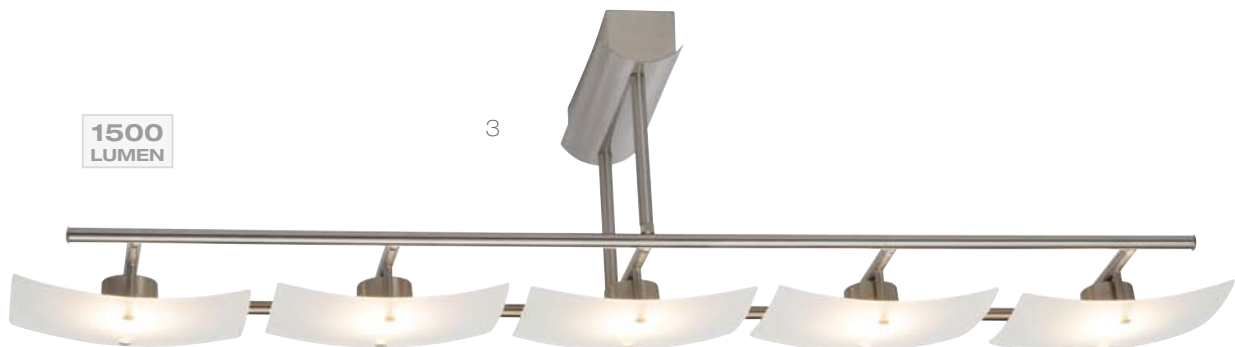

**LED**  
incl.

1-2

## Teide

white/gold  
metal/plastic

### 1. G94380/05

‡ 100mm ↔  
→ ø 420mm  
LED integr., 1 x 22,5W   
1 x 1800 lm, 3000 K, **A**



1



1800  
LUMEN

### 2. G94380/30

‡ 100mm ↔  
→ ø 420mm  
LED integr., 1 x 22,5W   
1 x 1800 lm, 3000 K, **A**



2



1800  
LUMEN





## Vulkan

white  
metal/acrylic

1. G94325/05 

± 200mm ↔

→ ∅ 500mm

LED integr., 1 x 25W 

1 x 2940 lm, 3000 K, 



2940  
LUMEN





1-3



1-3

## Free

white  
aluminium

### 1. G94336/05

‡ 80mm ↔ 105mm  
→ 100mm ø  
LED integr., 1 x 6W   
1 x 494 lm, 3000 K, **A+**



4 004353 206085



494  
LUMEN

### 2. G94337/05

‡ 50mm ↔ 135mm  
→ 140mm ø  
LED integr., 1 x 6W   
1 x 475 lm, 3000 K, **A+**



4 004353 206078



475  
LUMEN

### 3. G94338/05

‡ 50mm ↔ 260mm  
→ 100mm ø  
LED integr., 1 x 6W   
1 x 356 lm, 3000 K, **A+**



4 004353 206061



356  
LUMEN





1-3



1-3

## Soft

white  
metal

### 1. G94488/05

‡ 105mm ↔ 285mm  
→ 95mm ø  
LED integr., 1 x 6W   
1 x 350 lm, 3000 K, **A**



1



## Solution

white  
metal/acrylic

### 1. G94392/05

‡ 140mm ↔ 255mm  
→ 55mm ø  
LED integr., 2 x 3.5W   
2 x 335 lm, 3000 K, **A**



2



350  
LUMEN

### 2. G94393/05

‡ 136mm ↔ 255mm  
→ 55mm ø  
LED integr., 2 x 3.5W   
2 x 335 lm, 3000 K, **A**



3

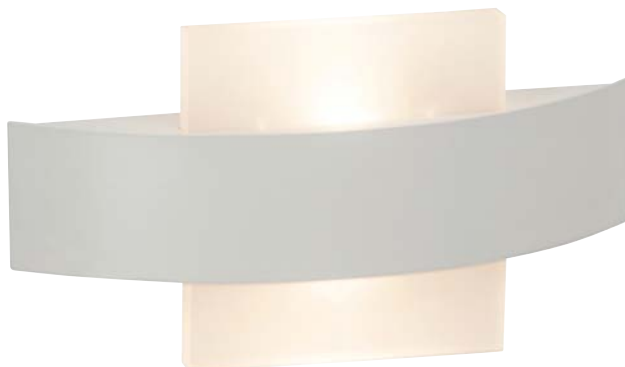

670  
LUMEN





**LED**  
incl.

1-2

## Fantasia

chrome  
metal/glass

### 1. G94438/15

↑ 75mm ↔ 250mm  
→ 250mm ø  
LED integr., 1 x 12W   
1 x 1200 lm, 3000 K, **A+**  
↗ 98216/70, 98169/00



1200  
LUMEN

### 2. G94439/15

↑ 75mm ↔ 335mm  
→ 335mm ø  
LED integr., 1 x 17W   
1 x 1700 lm, 3000 K, **A+**  
↗ 98217/70, 98170/00



1700  
LUMEN

**LED**  
incl.  
1-3

## Larina

chrome  
metal/glass

### 1. G94279/15

‡ 75mm ↔ 180mm  
→ 180mm ø  
LED integr., 1 x 10W   
1 x 1000 lm, 3000 K, **A+**  
98091/00, 98168/00



1000  
LUMEN

### 2. G94280/15

‡ 75mm ↔ 250mm  
→ 250mm ø  
LED integr., 1 x 12W   
1 x 1200 lm, 3000 K, **A+**  
98092/00, 98169/00



1200  
LUMEN

### 3. G94281/15

‡ 75mm ↔ 335mm  
→ 335mm ø  
LED integr., 1 x 17W   
1 x 1700 lm, 3000 K, **A+**  
98093/00, 98170/00



1700  
LUMEN

**LED**  
incl.

1-2

## Alica

chrome/transparent  
metal/plastic

### 1. G94156/15

↑ 290mm ↔  
→ ø 330mm  
LED integr., 1 x 15W   
1 x 900 lm, 3000 K, **A**



**900**  
LUMEN

## Svea

chrome/transparent  
metal/plastic

### 2. G94155/15

↑ 320mm ↔  
→ ø 330mm  
LED integr., 1 x 15W   
1 x 900 lm, 3000 K, **A**



**900**  
LUMEN

**LED**  
incl.

1 - 4

## Martino

chrome/transparent  
metal/glass

### 1. G94264/15

↓ 140mm ↔ 140mm  
→ 58mm ø  
LED integr., 1 x 5W   
1 x 420 lm, 3000 K, **A+**



1



**420**  
LUMEN

### 2. G94265/15

↓ 120mm ↔ 280mm  
→ 58mm ø  
LED integr., 2 x 5W   
2 x 420 lm, 3000 K, **A+**



2



**840**  
LUMEN

### 3. G94266/15

↓ 120mm ↔ 420mm  
→ 61mm ø  
LED integr., 3 x 5W   
3 x 420 lm, 3000 K, **A+**



3



**1260**  
LUMEN

### 4. G94267/15

↓ 280mm ↔ 280mm  
→ 61mm ø  
LED integr., 4 x 5W   
4 x 420 lm, 3000 K, **A+**



4



**1680**  
LUMEN

**LED**  
incl.

1-3

## Fine

chrome/transparent  
metal/glass

### 1. G94389/15

‡ 120mm ↔ 120mm  
→ 70mm ø  
LED integr., 1 x 4W,   
1 x 400 lm, 3000 K, **A+**  
↗98104/00



### 2. G94390/15

‡ 120mm ↔ 300mm  
→ 70mm ø  
LED integr., 2 x 4W,   
2 x 400 lm, 3000 K, **A+**  
↗98105/00

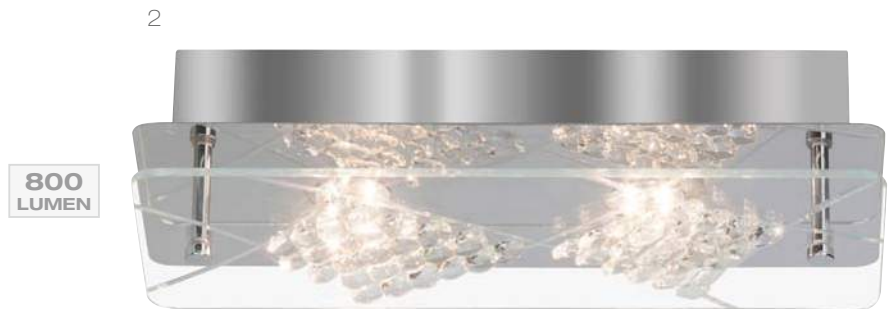

### 3. G94391/15

‡ 70mm ↔ 300mm  
→ 300mm ø  
LED integr., 4 x 4W,   
4 x 400 lm, 3000 K, **A+**  
↗98106/00





WALL & CEILING



**LED**  
incl.

1-2

## Cathleen

chrome  
metal/glass

### 1. G94163/15

↓ 55mm ↔  
→ ø 330mm  
LED integr., 1 x 15W   
1 x 900 lm, 3000 K,



1



900  
LUMEN

## Mollie

chrome  
metal/glass

### 2. G94164/15

↓ 55mm ↔  
→ ø 330mm  
LED integr., 1 x 15W   
1 x 900 lm, 3000 K,



2



900  
LUMEN

**LED**  
incl.  
1-2

## Salvia

chrome/white  
metal/glass

### 1. G94231/75

↑ 65mm ↔  
→ ø 330mm  
LED integr., 1 x 12W   
1 x 886 lm, 2700 K, **A**



### 2. G94232/75

↑ 65mm ↔ 330mm  
→ 330mm ø  
LED integr., 1 x 12W   
1 x 886 lm, 2700 K, **A**



**886**  
LUMEN

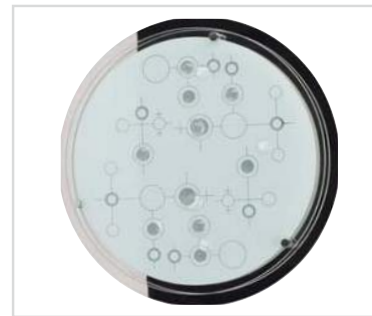

**886**  
LUMEN

2





**LED**  
incl.

1-5

## Mountain

chrome/white/transparent  
metal/glass

### 1. G11410/15

↑ 140mm ↔ 140mm  
→ 75mm ø  
LED integr., 1 x 5W   
1 x 400 lm, 3000 K, **A+**  
↗98115/98



**400**  
LUMEN



**800**  
LUMEN

### 2. G11429/15

↑ 65mm ↔ 340mm  
→ 140mm ø  
LED integr., 2 x 5W   
2 x 400 lm, 3000 K, **A+**  
↗98116/98



**1200**  
LUMEN

### 3. G11430/15

↑ 65mm ↔ 540mm  
→ 140mm ø  
LED integr., 3 x 5W   
3 x 400 lm, 3000 K, **A+**  
↗98117/98



**1600**  
LUMEN

### 4. G11435/15

↑ 65mm ↔ 340mm  
→ 340mm ø  
LED integr., 4 x 5W   
4 x 400 lm, 3000 K, **A+**  
↗98119/98



**1600**  
LUMEN

### 5. G11431/15

↑ 65mm ↔ 680mm  
→ 140mm ø  
LED integr., 4 x 5W   
4 x 400 lm, 3000 K, **A+**  
↗98118/98



**LED**  
incl.

1-5

## World

chrome/white/transparent  
metal/glass

### 1. G10431/15

↑ 65mm ↔ 660mm  
→ 140mm ø  
LED integr., 4 x 5W   
4 x 400 lm, 3000K, **A+**  
↗98111/98



1600  
LUMEN

### 2. G10430/15

↑ 65mm ↔ 500mm  
→ 140mm ø  
LED integr., 3 x 5W   
3 x 400 lm, 3000K, **A+**  
↗98110/98



1200  
LUMEN

### 3. G10429/15

↑ 65mm ↔ 340mm  
→ 140mm ø  
LED integr., 2 x 5W   
2 x 400 lm, 3000K, **A+**  
↗98109/98



800  
LUMEN

### 4. G10406/15

↑ 65mm ↔ 340mm  
→ 380mm ø  
LED integr., 6 x 5W   
6 x 400 lm, 3000K, **A+**  
↗98113/98



2400  
LUMEN

### 5. G10435/15

↑ 55mm ↔ 340mm  
→ 260mm ø  
LED integr., 4 x 5W   
4 x 400 lm, 3000K, **A+**  
↗98112/98



1600  
LUMEN

**LED**  
incl.

1-2

## Sao Paulo

chrome/white/transparent  
metal/glass

### 1. G94145/15

↓ 75mm ↔ 300mm  
→ 300mm ø  
LED integr., 9 x 3W  
9 x 160 lm, 3100 K, **A**  
98202/00



**1440**  
LUMEN



## New Orleans

chrome/white/transparent  
metal/glass

### 2. G94412/15

↓ 60mm ↔  
→ ø 300mm  
LED integr., 1 x 15W  
1 x 900 lm, 3000 K, **A**



**900**  
LUMEN







## Straight

satin nickel/chrome/white metal/glass

### 1. G07030/77

- ‡ 130mm ↔ 620mm
- 90mm ø
- LED integr., 3 x 4,5W
- 3 x 360 lm, 3000 K, **A+** 
- LED integr., 2 x 4W
- 2 x 320 lm, 3000 K, **A+** 
- ↗ 98107/98



1720 LUMEN

## Crossing

satin nickel/aluminium aluminium/acrylic

### 2. G08599/21

- ‡ 70mm ↔
- ø 450mm
- LED integr., 9 x 3W
- 9 x 240 lm, 3000 K, **A+** 
- ↗ 98398/00



2160 LUMEN

SEE OTHER VERSIONS  
ON PAGE  
**41, 286**

**LED**  
incl.

1-2



1-2

## Virginia

chrome  
metal/glass

### 1. G94404A15

↑ 145mm ↔  
→ 170mm ø 300mm  
LED, GU10, 4 x 3W   
4 x 250 lm, 3000 K, **A++**

**1000  
LUMEN**



1



### 2. G94405A15

↑ 95mm ↔ 300mm  
→ 300mm ø  
LED, GU10, 4 x 3W   
4 x 250 lm, 3000 K, **A++**  
98172/98

**1000  
LUMEN**



2



**LED**  
incl.

1-2

## Gudy

chrome/transparent/mattglass  
metal/glass

### 1. G94368/15

↑ 72mm ↔  
→ ø 340mm  
LED, GU10, 5 x 3W   
5 x 250 lm, 3000 K, **A++**



1

**1250**  
LUMEN



### 2. G94369/15

↑ 72mm ↔ 260mm  
→ 260mm ø  
LED, GU10, 4 x 3W   
4 x 250 lm, 3000 K, **A++**



2

**1000**  
LUMEN



**LED**  
incl.

1-3

## Rolanda

chrome/white  
metal/glass

### 1. G94222/75

‡ 60mm ↔ 300mm  
→ 300mm ø  
LED integr., 1 x 10W   
1 x 750lm, 3000 K, **A**



1

**750**  
LUMEN



## Malinda

chrome/white  
metal/glass

### 2. G94220/75

‡ 60mm ↔ 300mm  
→ 300mm ø  
LED integr., 1 x 10W   
1 x 750lm, 3000 K, **A**



2

**750**  
LUMEN



## Basic

white  
metal/glass

### 3. G94318/05

‡ 230mm ↔ 230mm  
→ 65mm ø  
LED integr., 1 x 10W   
1 x 750lm, 3000 K, **A**



3

**750**  
LUMEN



**LED**  
incl.

1-2

incl.  

1-2

## Trust

aluminium/chrome/white  
metal/glass

### 1. G94320/15

↑ 146mm ↔ 160mm  
→ 83mm ø  
LED integr., 1 x 5W   
1 x 320 lm, 3000 K, **A**   
↗ 98133/98



## Oval

satin nickel/white  
metal/glass

### 2. G94327/13

↑ 78mm ↔ 275mm  
→ 65mm ø  
LED integr., 2 x 3W   
2 x 200 lm, 3000 K, **A+**   
↗ 98134/98





**LED**  
incl.

1 - 2

## Budapest

satin nickel/transparent/frosted glass  
metal/glass

### 1. G94248/70

↑ 160mm ↔ 160mm

→ 47mm ø

LED integr., 1 x 5W 

1 x 380 lm, 3000 K, 



1





**380**  
LUMEN

### 2. G94249/70

↑                    ↔

→ 47mm ø 160mm

LED integr., 1 x 5W 

1 x 380 lm, 3000 K, 



2





**380**  
LUMEN



**LED**  
incl.  
1-2

## Script

satin nickel/chrome  
metal/plastic

- 1. G94398/77** 
- ‡ 645mm ↔ 200mm
  - 50mm ø
  - LED integr., 1 x 16W 
  - 1 x 1370 lm, 3000 K, 



- 2. G94399/77** 
- ‡ 1080mm ↔ 200mm
  - 50mm ø
  - LED integr., 1 x 32W 
  - 1 x 2860 lm, 3000 K, 



**1370**  
LUMEN

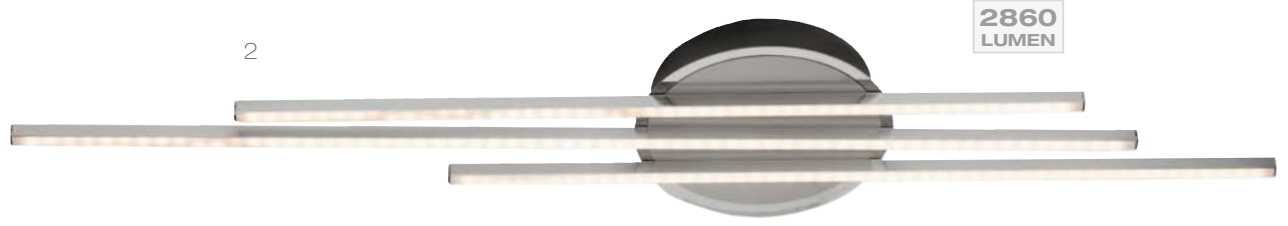

**2860**  
LUMEN



**LED**  
incl.

1-3

## Izon LED

aluminium  
metal

### 1. G94442/21

↑ 65mm ↔60mm  
→95mm ø

LED, GU10, 1 x 3W   
1 x 250 lm, 3000 K, **A++**



4 004353 241291



**250**  
LUMEN

### 2. G94443/21

↑ 65mm ↔145mm  
→95mm ø

LED, GU10, 2 x 3W   
2 x 250 lm, 3000 K, **A++**



4 004353 241307



**500**  
LUMEN

### 3. G94444/21

↑ 130mm ↔60mm  
→ 95mm ø

LED, GU10, 2 x 3W   
2 x 250 lm, 3000 K, **A++**



4 004353 241314



**500**  
LUMEN

LED  
incl.





## Fixed

aluminium  
aluminium

1. G94330/21 

↑ 150mm ↔ 150mm  
→ 113mm ø

LED integr., 1 x 6W   
1 x 540 lm, 3000 K, 



1



540  
LUMEN





## Music

satin nickel/white  
metal/plastic

1. G94403/13 

↑ 105mm ↔ 85mm  
→ 125mm ø

LED integr., 1 x 3W 

1 x 250 lm, 3000-6000 K, 

250  
LUMEN



4 004353 217449



For use **In-** and **Outdoor**,  
colour temperature: **warm white**,  
**high** soundquality, **IP 44**, free **App**



# WALL & CEILING



**LED**  
incl.

1-3

## Hardwood

oak/white/transparent  
wood/glass

### 1. G94477/35

‡ 64mm ↔ 290mm  
→ 290mm ø  
LED integr., 1 x 10W   
1 x 1200 lm, 3000 K, **A+**  
↗ 98295/00



1



### 2. G94478/35

‡ 64mm ↔ 400mm  
→ 400mm ø  
LED integr., 1 x 15W   
1 x 2100 lm, 3000 K, **A+**  
↗ 98296/00



2



### 3. G94479/35

‡ 64mm ↔ 570mm  
→ 293mm ø  
LED integr., 1 x 15W   
1 x 2100 lm, 3000 K, **A+**  
↗ 98298/00



3



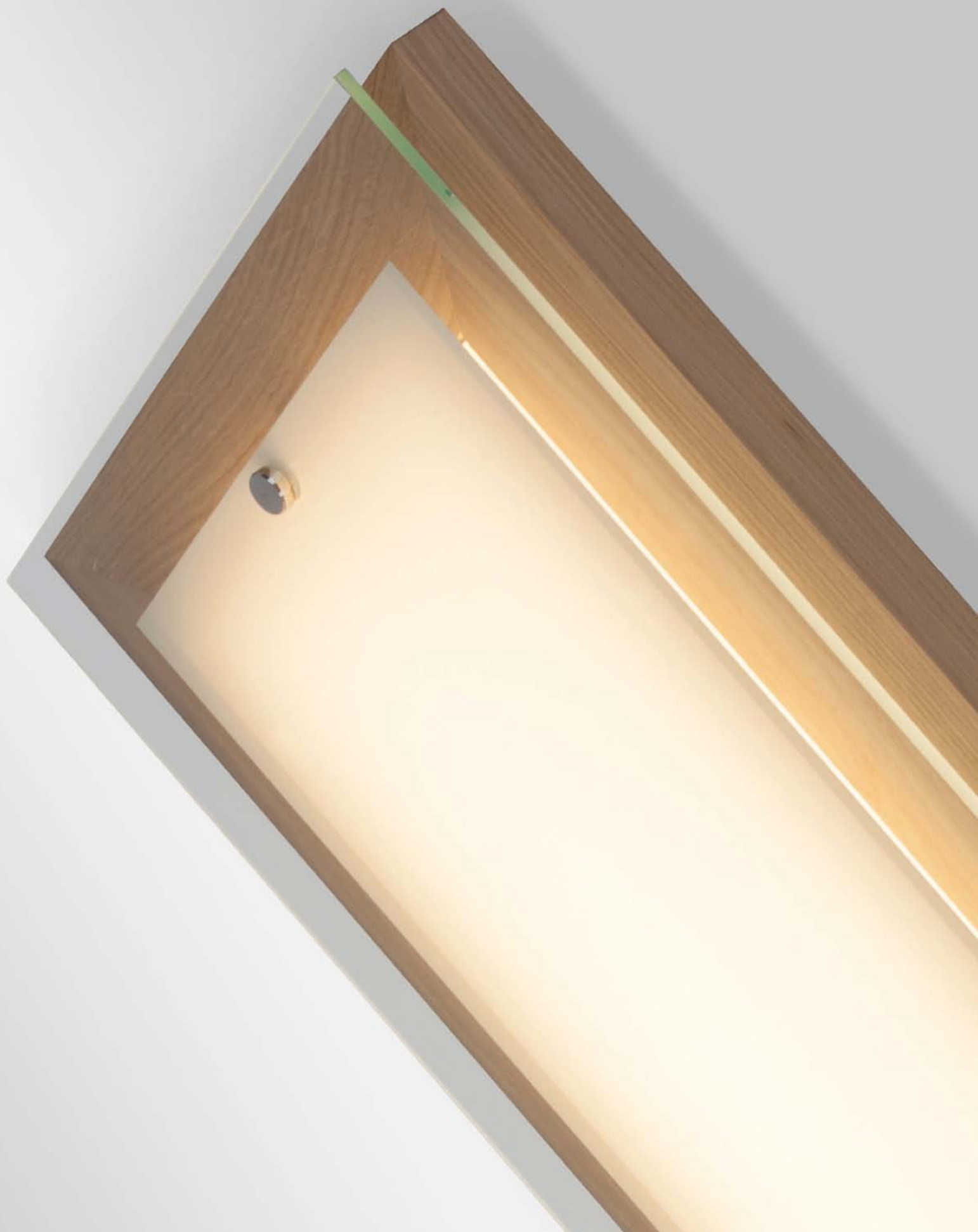





1-3



2



1-3

## Fakir

white  
metal/plastic

### 1. G94246/05

‡ 100mm ↔  
→ ø 300mm  
LED integr., 1 x 12W   
1 x 1150 lm, 3000 K, **A+**



4 004353 196287

1



1150  
LUMEN

### 2. G94306/05

‡ 110mm ↔  
→ ø 330mm  
LED integr., 1 x 14W   
1 x 1225 lm, 3000 K, **A+**



4 004353 202391

2



1225  
LUMEN

### 3. G98809/05

‡ 116mm ↔  
→ ø 370mm  
LED integr., 1 x 20W   
1 x 1790 lm, 3000 K, **A+**



4 004353 254604

3



1790  
LUMEN





1-2



1

## Falko

white  
metal/plastic

### 1. G94307/05

↑ 80mm ↔  
→ ø 360mm  
LED integr., 1 x 24W   
1 x 2105 lm, 3000/6000 K, **A+**



4 004353 202414



2105  
LUMEN

## Equinox

white  
metal/plastic

### 2. G94308/05

↑ 110mm ↔  
→ ø 350mm  
LED integr., 1 x 17W   
1 x 860/1020/940 lm  
3100/4200/6400 K, **A**



4 004353 202407

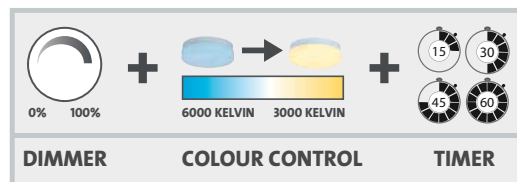

1020  
LUMEN





1-3



2



3

## Marius

chrome/white  
metal/plastic

### 1. G94227/75

↑ 105mm ↔  
→ ø 260mm  
LED integr., 1 x 12W   
1 x 800 lm, 3000 K, **A**



4 004353 193095



1

800  
LUMEN

### 2. G94228/75

↑ 105mm ↔  
→ ø 260mm  
LED integr., 1 x 12W   
1 x 800 lm, 3000 K, **A**



4 004353 193101



2

800  
LUMEN

## Palin

chrome/white  
metal/plastic

### 3. G98808/15

↑ 50mm ↔  
→ ø 300mm  
LED integr., 1 x 22W   
1 x 1740 lm, 3000 K, **A**  
/98359/00



4 004353 254598



3

1740  
LUMEN

**LED**  
incl.

1 - 4

**IP44**  
☾

1 - 4

## Formular

chrome/white  
metal/plastic

### 1. G28691/15 ☉

↑ 120mm ↔ 120mm  
→ 53mm ø  
LED integr., 1 x 5W   
1 x 320 lm, 3000 K, **A** →



4 004353 250378



1

**320**  
LUMEN



2

**640**  
LUMEN

### 2. G28692/15 ☉

↑ 65mm ↔ 256mm  
→ 120mm ø  
LED integr., 2 x 5W   
2 x 320 lm, 3000 K, **A** →



4 004353 250415



3

**960**  
LUMEN

### 3. G28693/15 ☉

↑ 65mm ↔ 369mm  
→ 120mm ø  
LED integr., 3 x 5W   
3 x 320 lm, 3000 K, **A** →



4 004353 250422

### 4. G28694/15 ☉

↑ 65mm ↔ 256mm  
→ 256mm ø  
LED integr., 4 x 5W   
4 x 320 lm, 3000 K, **A** →



4 004353 250439



4

**1280**  
LUMEN



**LED**  
incl.

1-3

## Vigor

white  
metal/plastic

### 1. G94131/05

↑ 80mm ↔  
→ ø 330mm  
LED integr., 1 x 15W   
1 x 850 lm, 4200 K,



1

**850**  
LUMEN



### 2. G94141/05

↑ 80mm ↔  
→ ø 330mm  
LED integr., 1 x 15W   
1 x 850 lm, 2800 K,



2

**850**  
LUMEN



### 3. G94151/05

↑ 80mm ↔  
→ 270mm ø 250mm  
LED integr., 1 x 10W   
1 x 600 lm, 2800 K,



3

**600**  
LUMEN



**LED**  
incl.

1-3

## Vigor

titanium/white  
metal/plastic

### 1. G94131/11

↑ 80mm ↔  
→ ø 330mm  
LED integr., 1 x 15W   
1 x 850 lm, 4200 K, **A**



1

**850**  
LUMEN



### 2. G94141/11

↑ 80mm ↔  
→ ø 330mm  
LED integr., 1 x 15W   
1 x 850 lm, 2800 K, **A**



2

**850**  
LUMEN



### 3. G94158/05

↑ 80mm ↔ 270mm  
→ ø  
LED integr., 1 x 15W   
1 x 900 lm, 3000 K, **A**



3

**900**  
LUMEN



**LED**  
incl.

1-5

## Tonia

violet/green/white  
metal/plastic

### 1. G94224/78

↑ 100mm ↔  
→ ø 255mm  
LED integr., 1 x 10W   
1 x 750 lm, 3000 K, 



### 2. G94224/74

↑ 100mm ↔  
→ ø 255mm  
LED integr., 1 x 10W   
1 x 750 lm, 3000 K, 



### 3. G94224/70

↑ 100mm ↔  
→ ø 255mm  
LED integr., 1 x 10W   
1 x 750 lm, 3000 K, 



## Elana

silver/white  
metal/plastic

### 4. G94214/70

↑ 95mm ↔  
→ ø 280mm  
LED integr., 1 x 10W   
1 x 750 lm, 3000 K, 



## Fiala

white  
nickel/plastic

### 5. G94216/05

↑ 90mm ↔  
→ ø 280mm  
LED integr., 1 x 10W   
1 x 750 lm, 3000 K, 



**LED**  
incl.

1-3

## Miramar LED

white/satin nickel/chrome  
metal/glass

### 1. G98813/05

↓ 80mm ↔  
→ ø 280mm  
LED integr., 1 x 12W   
1 x 950 lm, 3000 K, **A**



950  
LUMEN

### 2. G98813/13

↓ 80mm ↔  
→ ø 280mm  
LED integr., 1 x 12W   
1 x 950 lm, 3000 K, **A**



950  
LUMEN

### 3. G98813/15

↓ 80mm ↔  
→ ø 280mm  
LED integr., 1 x 12W   
1 x 950 lm, 3000 K, **A**



950  
LUMEN





## Kelly

chrome  
metal/plastic

1. G94410/15 ☺

↑ 70mm ↔ 300mm  
→ 300mm ∅  
LED, GU10., 4 x 3W   
4 x 250 lm, 3000 K, **A++**   
LED integr., 48 x 0,07W



4 004353 219450

1



1000  
LUMEN



WALL & CEILING

Brilliant







1-3

## City

chrome/transparent  
metal/glass

1. 93994/00 

↓                    ↔  
→90mm    ø 300mm  
QT14, G9, 1 x 33W



## Silke

satin nickel/transparent  
aluminium/glass

2. G94142/13 

↓                    ↔  
→90mm    ø 170mm  
QT14, G9, 1 x 33W   
1 x 485 lm, 2800 K



## Spock

satin nickel  
metal

3. 94166/13 

↓ 160mm    ↔152mm  
→95mm    ø

QT14, G9, 1 x 33W





1-2

## Gentle

satin nickel/brown/grey  
metal/glass/textile

1. 93509/20 

‡ 225mm ↔  
→ ø 450mm  
A60, E27, 4 x 42W



4 004353 205453

2. 93509/22 

‡ 225mm ↔  
→ ø 450mm  
A60, E27, 4 x 42W



4 004353 205446

1



2

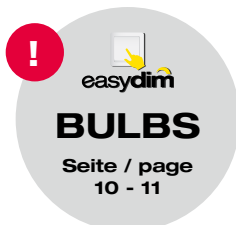



WALL & CEILING





1-3

## Andria

chrome/light brown  
metal/textile

### 1. 93581/20

‡ 160mm ↔  
→ ø 700mm  
A60, E27, 6 x 46W



1



### 2. 93522/20

‡ 250mm ↔  
→ ø 600mm  
A60, E27, 3 x 60W



2



### 3. 93580/20

‡ 160mm ↔  
→ ø 400mm  
A60, E27, 3 x 30W



3





1-3

## Andria

chrome/white  
metal/textile

### 1. 93581/05

‡ 160mm ↔  
→ ø 700mm  
A60, E27, 6 x 46W



### 2. 93522/05

‡ 265mm ↔  
→ ø 600mm  
A60, E27, 3 x 60W



### 3. 93580/05

‡ 160mm ↔  
→ ø 400mm  
A60, E27, 3 x 30W







## Andria

dark grey/chrome  
metal/textile

1.93522/63 

↓ 265mm ↔  
→ ∅ 600mm  
A60, E27, 3 x 60W

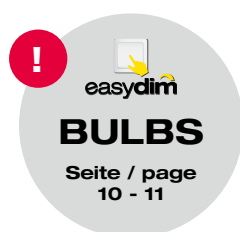



1-2

## Sandra

satin nickel/black/white  
metal/textile

### 1. 85010/76

‡ 180mm ↔  
→ 185mm ø 150mm  
D45, E14, 1 x 40W



### 2. 85010/75

‡ 180mm ↔  
→ 185mm ø 150mm  
D45, E14, 1 x 40W



1



SEE OTHER VERSIONS  
ON PAGE  
**108 - 109**

2





1-2



3

## Adrano

satin nickel/white/transparent  
metal/glass

1. 90215/13 ⊕

↑ 200mm ↔  
→ 125mm ø  
C35, E14, 1 x 40W  
↗ 92110/91, 92111/90



4 004353 001482

1



## Andaluz

satin nickel/white  
metal/glass

2. 90011/13 ⊕

↑ 440mm ↔  
→ 80mm ø 50mm  
C35, E14, 2 x 40W  
↗ 92173/91



4 004353 032813

2



3. 90010/13 ⊕

↑ 300mm ↔  
→ 80mm ø 50mm  
C35, E14, 1 x 40W  
↗ 92173/91



4 004353 032806

3





## Morris

chrome/white  
metal/glass

1.90007B15 

↑ 325mm ↔  
→ 109mm ø 68mm  
C35, E14, 1 x 40W  
↗ 92381/05





3 - 4



1 - 2

## Elysee

high-grade steel/white  
high-grade steel/glass

### 1. 90266/82

‡ 200mm ↔ 120mm  
→ 63mm ø  
C35, E14, 1 x 40W  
↗92121/91



4 004353 002854

### 2. 90267/82

‡ 400mm ↔ 120mm  
→ ø  
C35, E14, 2 x 40W  
↗92122/91



4 004353 002861



1



2

## Kyra

satin nickel/white  
metal/glass

### 3. 90339/13

‡ 410mm ↔ 180mm  
→ 120mm ø  
A60, E27, 1 x 60W



4 004353 060663



3

## Tip

titanium/white  
metal/glass

### 4. 90214/11

‡ 250mm ↔ 200mm  
→ 85mm ø  
A60, E27, 1 x 60W



4 004353 993411



4



1 - 2

## Sonian

satin nickel/white  
metal/glass

### 1. 90323/13

‡ 200mm ↔ 190mm  
→ 80mm ø  
C35, E14, 1 x 40W



### 2. 90324/13

‡ 200mm ↔ 190mm  
→ 80mm ø  
C35, E14, 1 x 40W



1



2





1 - 4



1 - 4

## Magnolia

white/black matt/chrome  
metal/glass

### 1. 93851/75

↓ 110mm ↔  
→ ∅ 290mm  
A60, E27, 2 x 40W



### 2. 93851/76

↓ 110mm ↔  
→ ∅ 290mm  
A60, E27, 2 x 40W



### 3. 93852/75

↓ 115mm ↔  
→ ∅ 350mm  
A60, E27, 3 x 40W



### 4. 93852/76

↓ 115mm ↔  
→ ∅ 350mm  
A60, E27, 3 x 40W





1 - 4

## Livorno

titanium  
glass/plastic

1. 90288/11 ☹

↓            ↔  
→ 90mm    ø 300mm  
A60, E27, 1 x 60W  
↗ 92153/91



## Tunis

high-grade steel/white  
high-grade steel/glass

2. 90218/82 ☹

↓            ↔  
→            ø 260mm  
A60 E27 1 x 60W



## Gibraltar

white  
metal/glass

3. 90078/05 ☹

↓            ↔  
→            ø 300mm  
A60, E27, 1 x 60W  
↗ 92172/05



## Rhodos

white  
metal / glass

4. 90265/05 ☹

↓            ↔  
→ 100mm    ø 250mm  
A60, E27, 1 x 60W







1-2

## Lippa

white matt  
metal/glass

### 1. 94422/05

‡ 260mm ↔ 230mm  
→ 90mm ø  
A60, E27, 1 x 60W



### 2. 94423/05

‡ 290mm ↔ 290mm  
→ 110mm ø  
A60, E27, 1 x 60W



1



2





1 - 2

## Fizzy

transparent/mat glass  
metal/glass

1.94421/00 

↑ 220mm ↔ 180mm  
→ 100mm ø  
C35, E14, 1 x 40W



1



## Niebla

chrome/white  
metal/glass

1.94424/15 

↑ 260mm ↔ 230mm  
→ 100mm ø  
A60, E27, 1 x 60W



2





1 - 4

## Miramar

white/chrome  
metal/glass

### 1. 90191/05

↓            ↔  
→ 80mm    ø 285mm  
A60, E27, 1 x 42W



### 2. 90196/05

↓ 150mm    ↔ 285mm  
→ 80mm    ø  
C35, E14, 1 x 40W



### 3. 90196/15

↓ 150mm    ↔ 285mm  
→ 80mm    ø  
C35, E14, 1 x 40W



### 4. 90191/15

↓            ↔  
→ 80mm    ø 285mm  
A60, E27, 1 x 42W





1-2

## Miramar

satin nickel/white  
metal/glass

### 1. 90191/13

↓      ↔  
→ 80mm    ø 285mm  
A60, E27, 1 x 42W



1



### 2. 90196/13

↓ 150mm    ↔ 285mm  
→ 80mm    ø  
C35, E14, 1 x 40W



2





1-6

## Mauritius

white/blue  
metal/glass

### 1. 90103/05

↓ 90mm ↔  
→ 300mm  
A60, E27, 1 x 60W



4 004353 955334



2



### 2. 90105/05

↓ 160mm ↔ 300mm  
→ 90mm ø  
A60, E27, 1 x 60W



4 004353 955457

3



### 3. 90104/05

↓ 90mm ↔  
→ 400mm  
A60, E27, 2 x 60W



4 004353 955396

SEE OTHER COLOURS  
ON PAGE  
**460**

### 4. 90103/03

↓ 90mm ↔  
→ 300mm  
A60, E27, 1 x 60W



4 004353 955389

5



### 5. 90105/03

↓ 160mm ↔ 300mm  
→ 90mm ø  
A60, E27, 1 x 60W



4 004353 955501

4



6



### 6. 90104/03

↓ 90mm ↔  
→ 400mm  
A60, E27, 2 x 60W



4 004353 955440



1-3

## Djerba

white  
metal/glass

### 1. 90102/05

↓ 100mm ↔  
→ ø 255mm  
A60, E27, 1 x 40W



1



### 2. 90101/05

↓ 82mm ↔  
→ ø 230mm  
A60, E27, 1 x 40W



2



### 3. 90100/05

↓ 80mm ↔  
→ ø 172mm  
D45, E14, 1 x 25W



3





1 - 4

## Isar

white  
metal/glass

### 1. 90238/05

‡ 110mm ↔  
→ ø 200mm  
A60, E27, 1 x 60W



### 2. 90239/05

‡ 110mm ↔  
→ ø 250mm  
A60, E27, 1 x 60W



### 3. 90240/05

‡ 110mm ↔180mm  
→ 180mm ø  
A60, E27, 1 x 60W



### 4. 90241/05

‡ 110mm ↔230mm  
→ 230mm ø  
A60, E27, 1 x 60W





1-2



1-2

## Morato

satin nickel/white/black  
metal

**1. 21412/05** 

↑ ↓     ↔  
→ 325mm ø 85mm  
D45, E14, 1 x 40W



4 004353 083143

**2. 21412/06** 

↑ ↓     ↔  
→ 325mm ø 85mm  
D45, E14, 1 x 40W



4 004353 083150







1 - 5

## Odine

white/grey deco  
metal/glass

### 1. 94046/05

↑ 180mm ↔ 300mm  
→ 75mm ø  
A60, E27, 1 x 60W



1



2



### 2. 94012/05

↑ ↔  
→ 90mm ø 300mm  
A60, E27, 1 x 60W



3



4



## Beliz

white/pattern  
metal/glass

### 3. 94057/70

↑ ↔  
→ 90mm ø 400mm  
A60, E27, 2 x 42W



### 4. 94056/70

↑ ↔  
→ 100mm ø 300mm  
A60, E27, 1 x 60W



5



## Earth

white/grey  
metal/glass

### 5. 94088/70

↑ ↔  
→ 90mm ø 400mm  
A60, E27, 2 x 42W

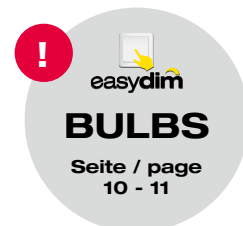

Seite / page  
10 - 11



1-2

## Klea

white/floral pattern  
metal/glass

1. 93909/70 ⊕

↑ 80mm ↔  
→ ∅ 250mm  
A60, E27, 1 x 60W



1



## Anais

white alabaster/gold  
metal/glass

2. 93983/70 ⊕

↑ 150mm ↔ 285mm  
→ 110mm ∅  
A60, E27, 1 x 60W



2





1 - 4

## Toulouse

white  
metal/glass

### 1. 90166/05

↑            ↔  
→ 105mm ø 310mm  
A60, E27, 1 x 60W



### 2. 90167/05

↑ 160mm ↔ 310mm  
→ 130mm ø  
A60, E27, 1 x 60W



## Provence

white  
metal/glass

### 1. 90168/05

↑            ↔  
→ 90mm ø 300mm  
A60, E27, 1 x 60W  
↗ 91807/05



### 2. 90169/05

↑ 160mm ↔ 310mm  
→ 130mm ø  
A60, E27, 1 x 60W  
↗ 91808/05





1 - 4

## Toulouse

white/brown  
metal/glass

### 1. 90166/20

↑ ↓     ↔  
→ 105mm ø 310mm  
A60, E27, 1 x 60W



### 2. 90167/20

↑ 160mm ↔ 310mm  
→ 130mm ø  
A60, E27, 1 x 60W



## Provence

white  
metal/glass

### 3. 90168/20

↑ ↓     ↔  
→ 90mm ø 300mm  
A60, E27, 1 x 60W  
↗ 91807/20



### 4. 90169/20

↑ 160mm ↔ 310mm  
→ 130mm ø  
A60, E27, 1 x 60W  
↗ 91808/20





1-6

## Mauritius

brown/orange  
metal/glass

### 1.90103/20

↑ 90mm ↔  
→ ø 300mm  
A60, E27, 1 x 60W



2



### 2.90105/20

↑ 160mm ↔ 300mm  
→ 90mm ø  
A60, E27, 1 x 60W



3



### 3.90104/20

↑ 90mm ↔  
→ ø 400mm  
A60, E27, 2 x 60W



5



### 4.90103/07

↑ 90mm ↔  
→ ø 300mm  
A60, E27, 1 x 60W



6

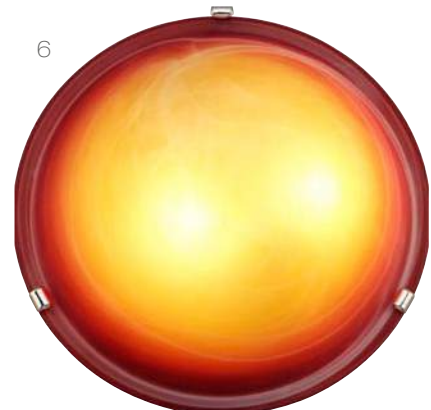

### 5.90105/07

↑ 160mm ↔ 300mm  
→ 90mm ø  
A60, E27, 1 x 60W



### 6.90104/07

↑ 90mm ↔  
→ ø 400mm  
A60, E27, 2 x 60W



SEE OTHER COLOURS  
ON PAGE  
**452**



1 - 4

## Fidschi

pine/oak/white  
metal/wood/glass

### 1. 90181/36

↑ 85mm ↔  
→ ø 300mm  
A60, E27, 1 x 60W  
↗92263/05



4 004353 892967



### 2. 90186/36

↑ 150mm ↔ 300mm  
→ 80mm ø  
C35, E14, 1 x 40W  
↗92264/05



4 004353 891366

2



### 3. 90186/35

↑ 150mm ↔ 300mm  
→ 80mm ø  
C35, E14, 1 x 40W  
↗92264/05



4 004353 890642

3



### 4. 90181/35

↑ 85mm ↔  
→ ø 300mm  
A60 E27 1 x 60W  
↗92263/05



4 004353 890659

4





## Athena

copper/transparent  
metal/glass

1.94427/29 

‡ 300mm ↔ 215mm

→ 85mm ø

A60, E27, 1 x 60W



4 004353 233708

1







1-3

## Nadia

brown  
metal/plastic

1. 94010/20 

↑ 220mm ↔ 160mm  
→ 80mm ø  
A60, E27, 1 x 60W



1



## Racket

chrome  
metal

2. 94414/15 

↑ ↔  
→ 105mm ø 250mm  
A60, E27, 1 x 40W



2

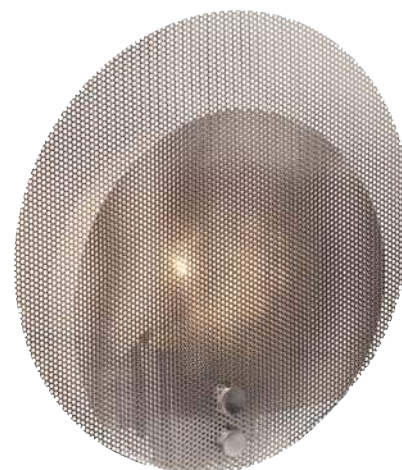

## Arezzo

bronze antique  
metal/glass

1. 28551/58 

↑ 635mm ↔  
→ 215mm ø  
A60, E27, 1 x 60W  
91684/20



3







1 - 2

## Kinley

white/brown  
metal/plastic

### 1. 93461/05

‡ 210mm ↔ 180mm  
→ 87mm ø  
A60, E27, 1 x 40W



### 2. 93461/20

‡ 210mm ↔ 180mm  
→ 87mm ø  
A60 E27 1 x 40W



1



2





1-2



1-2

## Sasha

satin nickel/brown metal

### 1. 94014/13

↑ 191mm ↔  
→ 290mm ø 118mm  
D45, E14, 1 x 40W



4 004353 155420

1

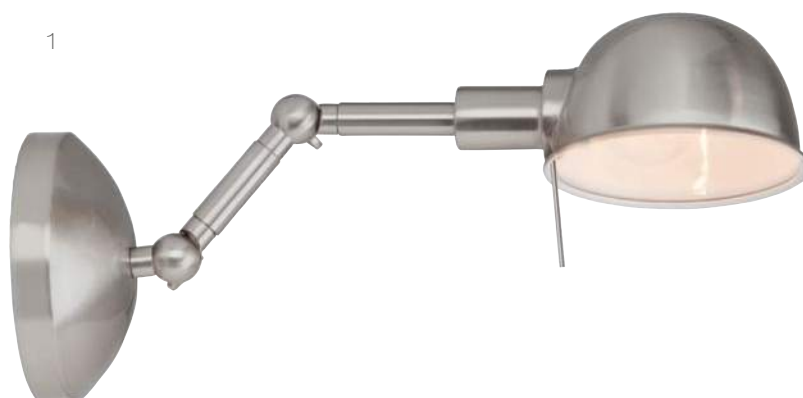

### 2. 94014/20

↑ 191mm ↔  
→ 290mm ø 118mm  
D45, E14, 1 x 40W



4 004353 153211

2





1-2



1-2

## Britney

grey  
metal

1.94271/22 

↑ 140mm ↔  
→ 320mm ø 130mm  
D45, E14, 1 x 40W



4 004353 199103



## Ronald

black/antik brass/transparent  
metal/glass

2.94273/76 

↑ 270mm ↔  
→ 370mm ø 220mm  
A60, E27, 1 x 42W



4 004353 199127





3 - 4



1 - 2



1 - 4

## Skirt

chrome/black  
metal

**1. 94385/15** ☉

‡ 200mm ↔  
→ 400mm ø 125mm  
QT14, G9, 1 x 18W



4 004353 231117

**2. 94385/76** ☉

‡ 200mm ↔  
→ 400mm ø 125mm  
QT14, G9, 1 x 18W



4 004353 216138



## Mika

black matt  
metal

**3. 94272/06** ☐

‡ 420mm ↔  
→ 580mm ø 200mm  
D45, E14, 1 x 40W



4 004353 199110



## Torana

black  
metal/plastic

**3. 94411/06** ☐

‡ 290mm ↔  
→ max. 770mm ø  
D45, E14, 1 x 40W



4 004353 227035



## Town

white/black  
metal/glass

1.94080/76 

↑ 260mm    ↔ 215mm

→ 90mm ∅

A60, E27, 1 x 60W



4 004353 157745

1





1 - 2

## Cat

white/black  
metal/glass

### 1. 05910/75

↑ 260mm    ↔ 225mm  
→ 80mm    ø  
A60, E27, 1 x 60W



### 2. 05998/75

↑            ↔  
→ 90mm    ø 300mm  
A60, E27, 1 x 60W



1



2





1 - 4

## Zebra

chrome/white  
metal/plastic

**1. 94425/15** 

‡ 220mm ↔ 180mm  
→ 95mm ø  
C35, E14, 1 x 40W



1



**2. 94425/05** 

‡ 220mm ↔ 180mm  
→ 95mm ø  
C35, E14, 1 x 40W



2



## Melville

satin nickel/white  
metal/plastic

**3. 94429/13** 

‡ 220mm ↔ 185mm  
→ 100mm ø  
C35, E14, 1 x 40W



3



**4. 94429/05** 

‡ 220mm ↔ 185mm  
→ 100mm ø  
C35, E14, 1 x 40W



4





1 - 3

## Perry

satin nickel  
metal

**1.94428/13** 

↓ 120mm ↔ 260mm  
→ 115mm ø  
A60, E27, 1 x 60W



4 004353 233715

1

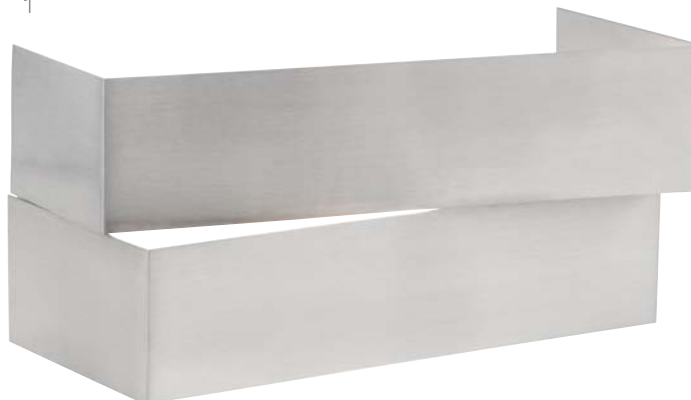

## Slash

satin nickel/white  
metal

**1.94426/13** 

↓ 115mm ↔ 300mm  
→ 75mm ø  
QT14, G9, 2 x 33W



4 004353 233074

2



**2.94426/05** 

↓ 115mm ↔ 300mm  
→ 75mm ø  
QT14, G9, 2 x 33W



4 004353 247712

3







1 - 4

## Bobbi

concrete grey  
metal/glass

### 1. 94458/70

↓ 85mm ↔ 210mm  
→ 105mm ∅  
A60, E27, 1 x 40W



### 2. 94459/70

↓ 110mm ↔ 280mm  
→ 160mm ∅  
A60, E27, 1 x 40W



## Lauren

concrete grey  
metal/glass

### 3. 94480/70

↓ 85mm ↔  
→ ∅ 190mm  
A60, E27, 1 x 40W



### 4. 94481/70

↓ 105mm ↔  
→ ∅ 255mm  
A60, E27, 2 x 40W





1 - 2

## Typhoon

concrete grey  
metal/glass

### 1. 94492/70

↓ 145mm ↔  
→ ø 340mm  
A60, E27, 2 x 60W



1



### 2. 94491/70

↓ 100mm ↔  
→ ø 290mm  
A60, E27, 1 x 60W



2

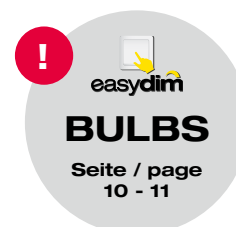



2-5



1



2-5

## Darius

black/warm white/cool white  
plastic

### 1. 53524A05

power supply  
‡ ↔ 1500mm  
→ ∅



4 004353 172045



### 2. G53500A05

‡ ↔ 1000mm  
→ ∅  
LED integr., 5W/m   
160 lm/m, 3000 K



4 004353 172052



160  
LUMEN

### 3. G53500A75

‡ ↔ 1000mm  
→ ∅  
LED integr., 5W/m   
180 lm/m, 6000 K



4 004353 172069



180  
LUMEN

### 4. G53501A05

‡ ↔ 5000mm  
→ ∅  
LED integr., 5W/m   
160 lm/m, 3000 K



4 004353 172076



160  
LUMEN

### 5. G53501A75

‡ ↔ 5000mm  
→ ∅  
LED integr., 5W/m   
180 lm/m, 6000 K



4 004353 172083



180  
LUMEN

# WALL & CEILING





# LED lightstrip

## CHANGES COLOR IN TIME WITH THE MUSIC

- ♪ 8 colors and 8 different programs
- ♪ 4 programs can „listen“ and flash in time with the music
- ♪ IP65 strip
- ♪ Remote control incl.
- ♪ Easy to use self-adhesive lightstrip
- ♪ Adjustable length:  
can be cut every 10cm

## Light Strip Music

transparent/multi-coloured  
metal/plastic

1. G94432A72 

↑ ↔ 5000mm

→ ∅

LED integr., 5 x 5,5W 



4 004353 238963

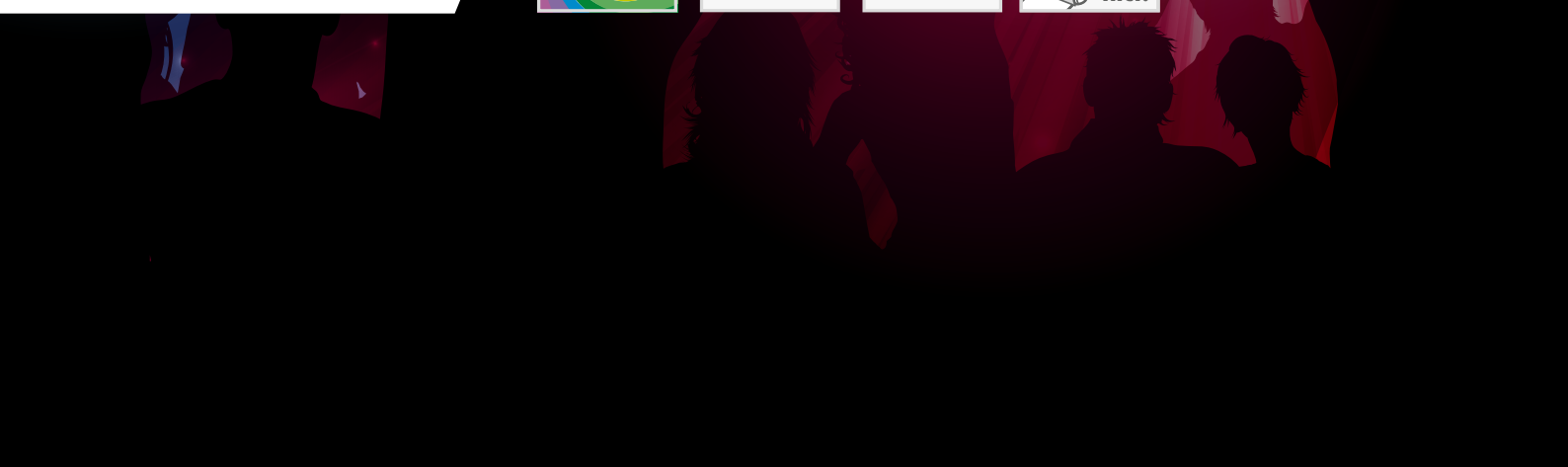



1-3



1-3

## Light Strip Led

transparent/multi-coloured  
metal/plastic

### 1. G93931A72

↑ ↔ 1000mm  
→ ∅  
LED integr., 30 x 0,08W



4 004353 138119



### 2. G93932A72

↑ ↔ 3000mm  
→ ∅  
LED integr., 90 x 0,08W



4 004353 138133

2



### 3. G93933A72

↑ ↔ 5000mm  
→ ∅  
LED integr., 150 x 0,08W



4 004353 138157

3







# FLOOR LAMPS





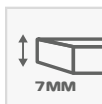

## Pluto

satin nickel/white  
metal/acrylic

1. G30558/13 

‡ 1820mm ↔ 320mm

→ 260mm ø

LED integr., 1 x 15W 

1 x 1500 lm, 3000 K, 



1

1500  
LUMEN

SEE OTHER VERSIONS  
ON PAGE  
**14-15, 360**



# FLOOR LAMPS





## Arthur

satin nickel/chrome  
metal/glass

### 1. G93032/77

± 1800mm ↔

→ 750mm ø 300mm

LED integr., 1 x 18W 

1 x 1600 lm, 3000 K, 

LED integr., 1 x 4,5W 

1 x 380 lm, 3000 K, 

98046/06



1600  
LUMEN

380  
LUMEN



## Demian

satin nickel/chrome  
metal/glass

### 1. G93033/77

↑ 1950mm ↔ 350mm

→ 620mm ø

LED integr., 1 x 18W 

1 x 1600 lm, 3000 K, 

LED integr., 1 x 4,5W 

1 x 380 lm, 3000 K, 

98255/00, 98256/00,

98046/06



4 004353 197925

1



1600  
LUMEN

380  
LUMEN





## Finn

satin nickel/white  
metal/glass

### 1. G93035/13

↑ 1800mm ↔ 610mm  
→ ø 325mm

LED integr., 1 x 18W 

1 x 1600 lm, 3000 K, 

LED integr., 1 x 4,5W 

1 x 380 lm, 3000 K, 

LB00000051, 98046/06





1-2



1-2





1-2

## Ollie



satin nickel/antique brass/white  
metal/glass

### 1. G93036/13

- ↑ 1800mm ↔
- 580mm ø 320mm
- LED integr., 1 x 18W
- 1 x 1600 lm, 3000 K, **A+** 
- LED integr., 1 x 4,5W
- 1 x 380 lm, 3000K, **A+** 
- ↗ LB00000051, 98046/06



### 2. G93036/31

- ↑ 1800mm ↔
- 580mm ø 320mm
- LED integr., 1 x 18W
- 1 x 1600 lm 3000 K, **A+** 
- LED integr., 1 x 4,5W
- 1 x 380 lm, 3000K, **A+** 
- ↗ LB00000051, 98046/06





1-2



1-2



1-2



1-2

## Sunniva

satin nickel  
metal/glass

### 1. G93025/13

- ‡ 1600 - 1920mm ↔ 400mm
- 250mm ø
- LED integr., 1 x 19W
- 1 x 1600 lm, 3000 K, **A**
- LED integr., 1 x 5W
- 1 x 380 lm, 3000 K, **A+**
- ↗ 98046/06



4 004353 176012

### 2. G93026/13

- ‡ 1600 - 1920mm ↔ 465mm
- 250mm ø
- LED integr., 1 x 19W
- 1 x 1600 lm, 3000 K, **A**
- LED integr., 1 x 5W
- 1 x 380 lm, 3000 K, **A+**
- ↗ 98046/06



4 004353 176029



# FLOOR LAMPS







## Lucy

satin nickel/white  
metal/glass

### 1. G93004/13

↑ 1800mm ↔

→ 400mm ø 300mm

LED, E27, 1 x 5,5W

1 x 470 lm, 3000 K, **A**

LED, E14, 1 x 3W

1 x 250 lm, 3000K, **A+**

↗ 92396/05, 92395/05



470  
LUMEN

250  
LUMEN



1-2



1-2



2

## Spari LED

silver/white  
metal/plastic

### 1. G98810/05

↑ 1800mm ↔  
→ ∅ 250mm  
LED, E27, 1 x 10W   
1 x 810 lm, 2700 K, 

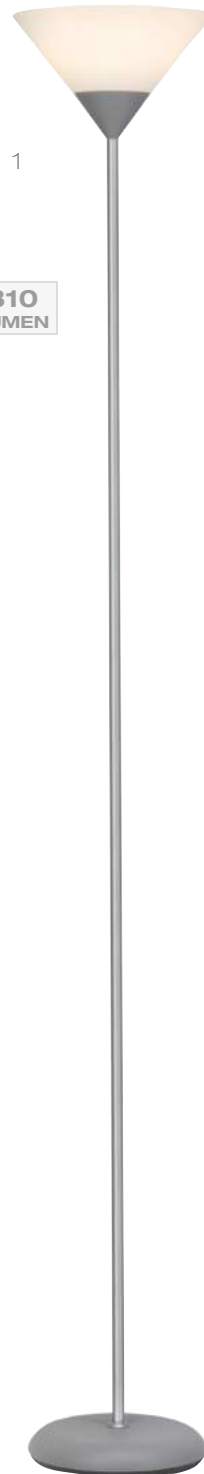



810  
LUMEN



810  
LUMEN

240  
LUMEN

### 2. G98811/05

↑ 1800mm ↔  
→ 410mm ∅ 250mm  
LED, E27, 1 x 10W   
1 x 810 lm, 2700 K,   
LED, E14, 1 x 3W   
1 x 240 lm, 2700 K, 







## Carlino

satin nickel  
metal/glass

### 1. G94818/13

± 1500mm ↔  
→ 660mm ø

LED integr., 1 x 4,5W   
1 x 380 lm, 3000 K, 



1

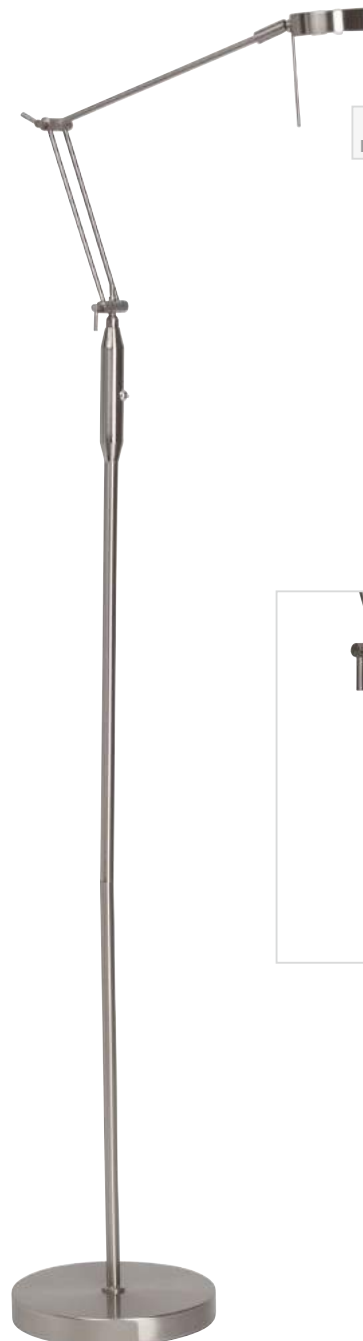

380  
LUMEN



# FLOOR LAMPS





1-2



2

## Ravenna

satin nickel/white  
metal/glass

### 1. G89360/13

↑ 1800mm ↔ 420mm  
→ ∅  
QT-DE12, R7s, 1 x 230W   
1 x 4646 lm, 2900 K  
✈ 92197/98



### 2. G89361/13

↑ 1800mm ↔  
→ 420mm ∅  
QT-DE12, R7s, 1 x 230W   
1 x 4646 lm, 2900 K  
QT14, G9, 1 x 33W   
1 x 458 lm, 2800 K  
✈ 92197/98, 92187/98





1-2



1-2

## Ravenna

antique brass/white/old copper/champagne metal/glass

### 1. G89361/31

↑ 1800mm ↔  
→ 420mm ø  
QT-DE12, R7s, 1 x 230W ☑  
1 x 4646 lm, 2900 K  
QT14, G9, 1 x 33W ☑  
1 x 458 lm, 2800 K  
↗ 92197/98, 92187/98



### 2. G89361/56

↑ 1800mm ↔  
→ 420mm ø  
QT-DE12, R7s, 1 x 230W ☑  
1 x 4646 lm, 2900 K  
QT14, G9, 1 x 33W ☑  
1 x 458 lm, 2800 K  
↗ 92197/83, 92187/83





1 - 3

## Jersey

white/silver/black  
metal

### 1. 93034/05

‡1770mm ↔  
→ ∅ 220mm  
QT-DE12, R7s, 1 x 230W



4 004353 244858

### 2. 93034/58

‡1770mm ↔  
→ ∅ 220mm  
QT-DE12, R7s, 1 x 230W



4 004353 244865

### 3. 93034/06

‡1770mm ↔  
→ ∅ 220mm  
QT-DE12, R7s, 1 x 230W



4 004353 243967



# FLOOR LAMPS







## Darlington

satin nickel/white  
metal/glass

### 1. 27160/13

↑ 1780mm ↔  
→ ∅ 280mm  
A60, E27, 1 x 100W  
D45, E27, 1 x 60W  
↗ 92228/91



4 004353 036217

### 2. 27161/13

↑ 1780mm ↔  
→ 420mm ∅ 280mm  
D45, E27, 1 x 60W  
D45, E14, 1 x 25W  
R50, E14, 1 x 40W  
↗ 92228/91, 92229/91



4 004353 036248





1-2



1-2

## Spari 4

black/white/silver/white  
aluminium/plastic

### 1. 93008/76

↑ 1800mm ↔  
→ 410mm ø 250mm  
A60, E27, 1 x 60W  
D45, E14, 1 x 25W



### 2. 93008/05

↑ 1800mm ↔  
→ 410mm ø 250mm  
A60, E27, 1 x 60W  
D45, E14, 1 x 25W



**LED**  
incl.

incl.  



## Meet

satin nickel/chrome  
metal/acrylic

1. **G94825/77** 

‡ 1500mm ↔ 240mm

→ 120mm ø

LED integr., 1 x 16W 

1 x 1385 lm, 3000 K, 



1385  
LUMEN





## Perfect

satin nickel/white  
metal/glass

### 1. G17456/13

- ‡ 1410mm ↔
- ø 400mm
- LED integr., 2 x 5W
- 2 x 400 lm, 3000 K, **A+**
- LED integr., 1 x 2W
- 1 x 180 lm, 2700 K, **A++**
- ↗ 98210/05, 98353/00

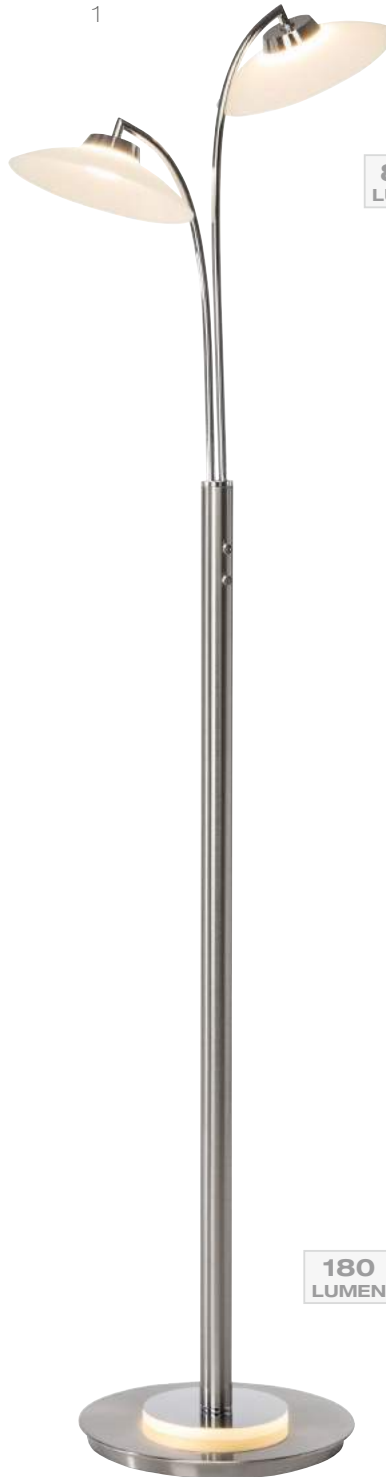

1

**800  
LUMEN**

SEE OTHER VERSIONS  
ON PAGE  
**566**



**180  
LUMEN**





## Filmo

chrome  
metal/glass

1.94929/15 

↑ 1458mm ↔

→ ø 670mm

A60, E27, 2 x 60W



4 004353 250361





## Mettle

chrome/black  
metal/wood

**1.92789/76** 

‡ 1600mm ↔ 700mm  
→     ∅ 190mm  
R80, E27, 1 x 60W  
A60, E27, 1 x 40W



4 004353 130588

1



## Cine

chrome/ black  
metal/glass/wood

**2.HK13018S70** 

‡ 1220-1740mm ↔  
→     ∅ 840mm  
A60, E27, 1 x 60W



4 004353 191206

2





1-2



1-2

## Octavia

chrome/white/black  
metal

### 1. 92736/75

‡ 1700mm ↔  
→ 700mm ø  
A60, E27, 1 x 40W



4 004353 116810

### 2. 92736/76

‡ 1700mm ↔  
→ 700mm ø  
A60, E27, 1 x 40W



4 004353 116827



SEE OTHER VERSIONS  
ON PAGE  
**576**



1-2



1-2

## Winston

white matt/black  
metal

**1.92710/05** 

↑ 1800mm ↔  
→1300mm ø 320mm  
A60, E27, 1 x 60W



4 004353 106392

**2.92710/06** 

↑ 1800mm ↔  
→1300mm ø 320mm  
A60, E27, 1 x 60W



4 004353 106408







## Vessa

chrome/white  
metal/plastic

1.92940/75 

↑ 1660mm ↔

→ 1220mm ∅

A60, E27, 1 x 60W





## Nereide

chrome/black/copper  
metal

### 1. 92645/15

‡ 1800mm ↔  
→1320mm ø 300mm  
A60, E27, 1 x 100W



1



### 2. 92645/29

‡ 1800mm ↔  
→1320mm ø 300mm  
A60, E27, 1 x 100W



2





1-2

## Widow

white/dark wood/white  
metal/wood/textile

### 1. 94916/05

‡ 1000-1440mm ↔  
→ ø 780mm  
A60, E27, 1 x 60W



4 004353 245381

### 2. HK12496S70

‡ 1000-1440mm ↔  
→ ø 780mm  
A60, E27, 1 x 60W



4 004353 191190



1



2



## Brandon

white / wood light  
wood / textile

1.94917/05 

↑ 1450mm ↔  
→ 400mm ∅

A60, E27, 1 x 60W





1-2



1-2

## Carlyn

wood light/white  
metal/wood/textile

1. 09958A75 

↑ 1630mm ↔  
→ 800mm ø 300mm  
A60, E27, 1 x 60W



## Elias

wood light/black  
metal/wood

2. 94919/76 

↑ 1400mm ↔  
→ 1420mm ø 280mm  
A60, E27, 1 x 42W



SEE OTHER VERSIONS  
ON PAGE  
**530**

# FLOOR LAMPS





## New York

satin nickel/black  
metal/textile

### 1. G94908/06

‡ 1600mm ↔  
→ ∅ 450mm  
A60, E27, 1 x 60W  
LED integr., 8 x 1,5W   
8 x 95 lm, 3000 K, **A+**



4 004353 240829

1



760  
LUMEN

SEE OTHER VERSIONS  
ON PAGE  
**538**



LED  
incl.

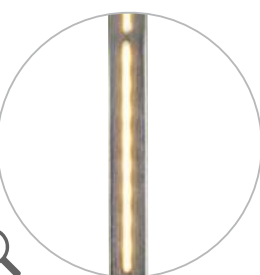



## Dublin

black  
metal/textile

1.92923/06 

‡ 1800mm ↔400mm  
→1250mm ø  
A60, E27, 1 x 60W



1



SEE OTHER VERSIONS  
ON PAGE  
**539**





## Nerva

satin nickel/white  
metal/paper

### 1. 92603/81

↑ 1450mm ↔ 180mm  
→ 180mm ø  
C35, E14, 2 x 40W



### 2. 92603/75

↑ 1450mm ↔ 180mm  
→ 180mm ø  
C35, E14, 2 x 40W



1



2





## Becca

white  
metal/paper

1.92961/05 

‡ 1250mm ↔345mm

→ ∅

A60, E27, 2 x 60W



1





1-3



1-3

## Lucie

chrome/red/blue/green/white  
metal/plastic

### 1. 93020/71

‡ 1800mm ↔  
→ 500mm ø 280mm  
TC-TSE, E27, 1 x 20W



4 004353 149429

### 2. 93020/73

‡ 1800mm ↔  
→ 500mm ø 280mm  
TC-TSE, E27, 1 x 20W



4 004353 149436

### 3. 93020/74

‡ 1800mm ↔  
→ 500mm ø 280mm  
TC-TSE, E27, 1 x 20W



4 004353 149443



# FLOOR LAMPS









# TABBLE LAMPS



## Melina

chrome  
metal

### 1. G92949/15

↑ 310mm ↔  
→ ø 300mm  
LED integr., 1 x 11W



1



## Adriana

chrome  
metal

### 2. G92970/15

↑ 330mm ↔ 220mm  
→ 260mm ø  
LED integr., 1 x 12W



2

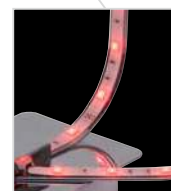
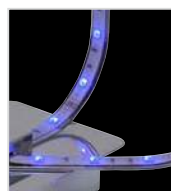
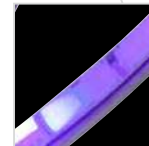
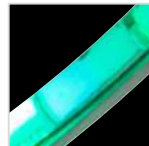
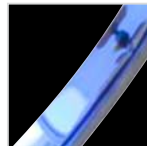



# TABLE LAMPS







1



1-3

## Evergreen

chrome/transparent  
metal/glass

### 1. G92752/72

↑ 230mm ↔  
→ ø 120mm  
LED, E14, 1 x 0,8W   
C35, E14, 1 x 25W



### 2. 92752/00

↑ 240mm ↔  
→ ø 120mm  
TC-HSE, E14, 1 x 13W  
C35, E14, 1 x 25W  
↗ 92506/00



### 3. 92852/00

↑ 224mm ↔ 110mm  
→ ø  
TC-HSE, E14, 1 x 13W  
C35, E14, 1 x 25W  
↗ 92506/00





## Evergreen

white  
plastic

1. G96284/72 

↑ 280mm ↔

→ ø 154mm

LED integr., 1 x 2W 



4 004353 246029



1





1-3



1-3

## Daisy

satin nickel/white/green/lila  
metal/glass

### 1. G92968/05

‡ 200mm ↔  
→ ø 85mm  
LED integr., 1 x 3W   
1 x 280 lm, 3000 K, 



4 004353 189340

### 2. G92968/04

‡ 200mm ↔  
→ ø 85mm  
LED integr., 1 x 3W   
1 x 280 lm, 3000 K, 



4 004353 189357

### 3. G92968/78

‡ 200mm ↔  
→ ø 85mm  
LED integr., 1 x 3W   
1 x 280 lm, 3000 K, 



4 004353 189364

1

280  
LUMEN



2

280  
LUMEN



3

280  
LUMEN



# TABLE LAMPS



**LED**  
incl.

1-3



1-3

## Managua

blue/white/pink  
plastic

### 1. G92960A03

‡ 250mm ↔  
→ ø 160mm  
LED integr., 1 x 2,5W   
1 x 230 lm, 3000 K, **A++**



1



230  
LUMEN

### 2. G92960A05

‡ 250mm ↔  
→ ø 160mm  
LED integr., 1 x 2,5W   
1 x 230 lm, 3000 K, **A++**



2



230  
LUMEN

### 3. G92960A17

‡ 250mm ↔  
→ ø 160mm  
LED integr., 1 x 2,5W   
1 x 230 lm, 3000 K, **A++**



3



230  
LUMEN



1 - 4

## Fuerte

blue/red/white/violet  
glas

### 1. 92975/03

‡ 240mm ↔  
→ ø 130mm  
D45, E14, 1 x 40W



### 2. 92975/01

‡ 240mm ↔  
→ ø 130mm  
D45, E14, 1 x 40W



### 3. 92975/05

‡ 240mm ↔  
→ ø 130mm  
D45, E14, 1 x 40W



### 4. 92975/08

‡ 240mm ↔  
→ ø 130mm  
D45, E14, 1 x 40W





## Handy

black matt/transparent  
metal/glass

1. 92984/06 

↑ 260mm ↔  
→ ø 190mm  
A60, E27, 1 x 60W



1



## Movie

black  
metal

2. 92709/06 

↑ 390mm ↔238mm  
→238mm ø  
QPAR51, GU10, 1 x 35W



2



SEE OTHER VERSIONS  
ON PAGE  
71



1-2

## Grigory

black/copper  
metal/textile

1. 94905/76 

↑ 485mm ↔  
→ ∅ 245mm  
A60, E27, 1 x 60W



4 004353 240416

## Home

black/copper  
metal

2. 94906/76 

↑ 270mm ↔ 245mm  
→ 245mm ∅  
A60, E27, 1 x 60W



4 004353 240423

SEE OTHER COLOURS  
ON PAGE  
**541**

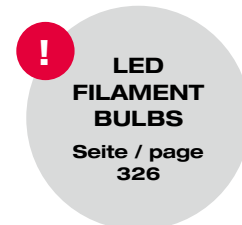





1-2



1-2

## Carmen

concrete  
metal/glass

### 1. 94927/70

‡ 310mm ↔ 260mm  
→ 220mm ∅  
A60, E27, 1 x 40W



4 004353 249211

### 2. 94928/70

‡ 310mm ↔ 260mm  
→ 220mm ∅  
A60, E27, 1 x 40W



4 004353 249228

1



2



# TABLE LAMPS





1-3



1-3

## Elias

wood light/green/white/black  
metal/wood

### 1. 94918/74

↑ 540mm ↔  
→ 700mm ø  
A60, E27, 1 x 42W



4 004353 245428



### 2. 94918/75

↑ 540mm ↔  
→ 700mm ø  
A60, E27, 1 x 42W



4 004353 245411



### 3. 94918/76

↑ 540mm ↔  
→ 700mm ø  
A60, E27, 1 x 42W



4 004353 245404



SEE OTHER VERSION  
ON PAGE  
**508**

# TABLE LAMPS







## Yorkshire

oak  
wood

**1. 94922/35** 

‡ 100mm ↔  
→ ø 100mm  
A60, E27, 1 x 60W



**2. 94921/35** 

‡ 100mm ↔ 100mm  
→ 100mm ø  
A60, E27, 1 x 60W



1



2

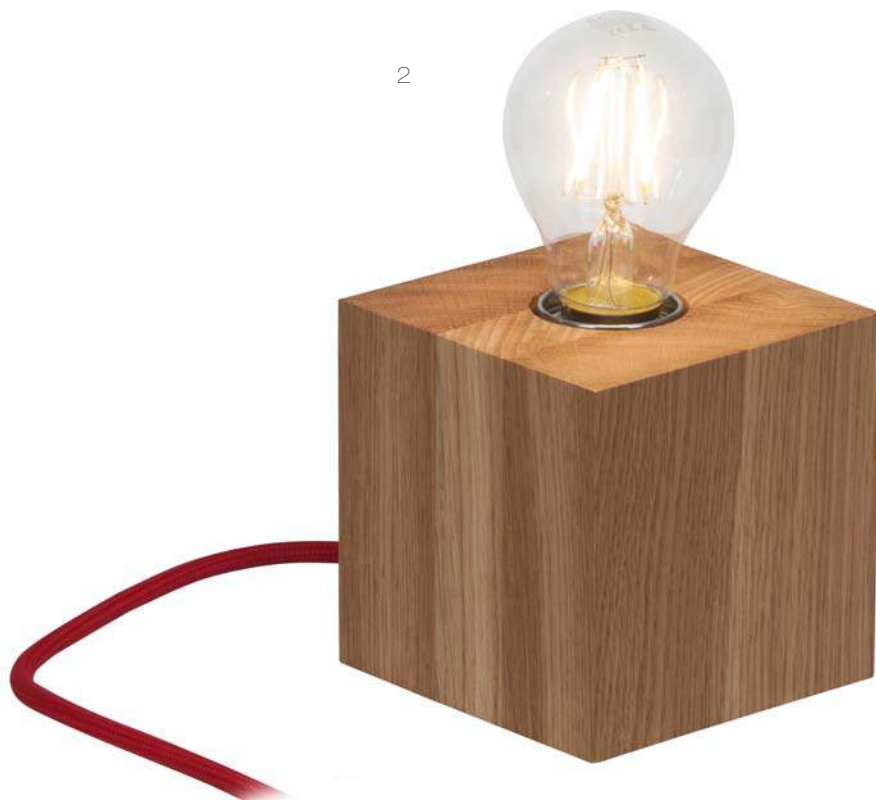

# TABLE LAMPS





## Umbrella

oak/anthracite  
wood/textile

1.94948/63 

‡ 660mm ↔  
→ ø 300mm  
A60, E27, 1 x 60W

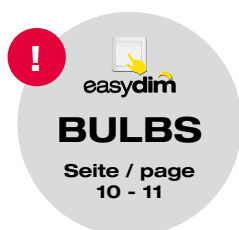



1-2

## Plant

oak/anthracite/white  
wood/textile

### 1. 94924/63

‡ 310mm ↔ 150mm  
→ 150mm ø  
A60, E27, 1 x 60W



1



### 2. 94923/35

‡ 310mm ↔  
→ ø 175mm  
A60, E27, 1 x 60W



2







## Eiffel Tower

black/beige  
metal/textile

1.94860/09 

↑ 610mm ↔  
→ ø 290mm  
A60, E27, 1 x60W



1



# TABLE LAMPS





## New York

satin nickel/black  
metal/textile

### 1. G94907/06

↑ 520mm ↔  
→ ∅ 300mm

A60, E27, 1 x 60W  
LED integr., 2 x 2,9W   
2 x 190 lm, 3000 K, **A+**



4 004353 240812

1



SEE OTHER VERSION  
ON PAGE  
**510**

**380**  
LUMEN



**LED**  
incl.





1-2



1-2

## Dublin

white/black  
metal/textile

### 1. 92922/05

‡ 660mm ↔ 180mm  
→ 440mm ø  
A60, E27, 1 x 60W



4 004353 173677

### 2. 92922/06

‡ 660mm ↔ 180mm  
→ 440mm ø  
A60, E27, 1 x 60W



4 004353 173684



SEE OTHER VERSIONS  
ON PAGE  
**511**



1-2

## Rom

chrome/white/transparent  
metal/glass/textile

1.94861/05 

↑ 380mm ↔  
→ ø 200mm  
A60, E27, 1 x 60W



1



## Quadri

chrome/white/transparent  
metal/plastic/textile

2.94913/15 

↑ 360mm ↔  
→ ø 200mm  
A60, E27, 1 x 40W



2

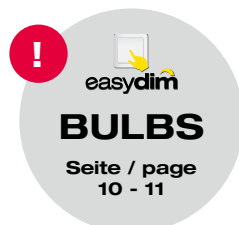



1-2

## Grigory

chrome/white/gold/black  
metal/textile

1

### 1. 94905/75

↑ 485mm ↔  
→ ø 245mm  
A60, E27, 1 x 60W



### 2. 94905/86

↑ 485mm ↔  
→ ø 245mm  
A60, E27, 1 x 60W



2



SEE OTHER COLOUR  
ON PAGE  
**527**



1 - 3

## Aglae

satin nickel/white/anthracite/grey  
metal/textile

### 1. 94873/05

‡ 430mm ↔165mm  
→165mm ø  
D45, E14, 1 x 40W



4 004353 219023

### 2. 94873/63

‡ 430mm ↔165mm  
→165mm ø  
D45, E14, 1 x 40W



4 004353 219016

### 3. 94873/22

‡ 430mm ↔165mm  
→165mm ø  
D45, E14, 1 x 40W



4 004353 219009





1 - 3

## Kasha

chrome/blue/white/pink  
metal/textile

### 1. 94874/03

‡ 420mm ↔  
→ ∅ 160mm  
D45, E14, 1 x 40W



1



### 2. 94874/05

‡ 420mm ↔  
→ →160mm  
D45, E14, 1 x 40W



2



### 3. 94874/17

‡ 420mm ↔  
→ ∅ 160mm  
D45, E14, 1 x 40W



3







1 - 6

## Primo

dark grey/violet/red/white/peach/beige  
ceramic/textile

### 1. 61047/63

‡ 230mm ↔  
→ ø 200mm  
D45, E14, 1 x 40W



4 004353 131295

1



2



### 2. 61047/78

‡ 230mm ↔  
→ ø 200mm  
D45, E14, 1 x 40W



4 004353 131301

### 3. 61047/01

‡ 230mm ↔  
→ ø 200mm  
D45, E14, 1 x 40W



4 004353 035678

3



4



### 4. 61047/05

‡ 230mm ↔  
→ ø 200mm  
D45, E14, 1 x 40W



4 004353 035715

### 5. 61047/38

‡ 230mm ↔  
→ ø 200mm  
D45, E14, 1 x 40W



4 004353 035746

5



6



### 6. 61047/28

‡ 230mm ↔  
→ ø 200mm  
D45, E14, 1 x 40W



4 004353 106231



1 - 3

## Paolo

red/green/brown  
ceramic/textile

### 1. 92907/01

‡ 230mm ↔  
→ ø 170mm  
D45, E14, 1 x 40W



1

### 2. 92907/04

‡ 230mm ↔  
→ ø 170mm  
D45, E14, 1 x 40W



2

### 3. 92907/20

‡ 230mm ↔  
→ ø 170mm  
D45, E14, 1 x 40W



3



## Tarifa

satin nickel/white  
metal/textile

1.62447/05 

↑ 240mm ↔

→ ∅ 205mm

D45, E14, 1 x 40W



1





1 - 2

## Lomé

black/chrome/white  
metal/textile

### 1. 92732/06

‡ 290mm ↔  
→ ø 160mm  
D45, E14, 1 x 40W



1



### 2. 92732/75

‡ 290mm ↔  
→ ø 160mm  
D45, E14, 1 x 40W



2





1 - 4

## Isi

satin nickel/brown/grey/dark brown/dark grey  
metal/plastic

### 1. 02747/20

↑ 360mm ↔  
→ ø 130mm  
C35, E14, 1 x 40W



### 2. 02747/22

↑ 360mm ↔  
→ ø 130mm  
C35, E14, 1 x 40W



### 3. 02747/23

↑ 360mm ↔  
→ ø 130mm  
C35, E14, 1 x 40W



### 4. 02747/63

↑ 360mm ↔  
→ ø 130mm  
C35, E14, 1 x 40W





1 - 3

## Isi

satin nickel/lila/white/multi-coloured  
metal/plastic

### 1. 02747/78

↑ 360mm ↔  
→ ø 130mm  
C35, E14, 1 x 40W



### 2. 02747/05

↑ 360mm ↔  
→ ø 130mm  
C35, E14, 1 x 40W



### 3. 02747/71

↑ 360mm ↔  
→ ø 130mm  
C35, E14, 1 x 40W





1 - 2

## Pop

white/purple/white/green floral pattern  
metal/glass

### 1. 01947/78

‡ 140mm ↔  
→ ø 140mm  
D45, E14, 1 x 40W  
↗ 91826/78



### 2. 01947/74

‡ 140mm ↔  
→ ø 140mm  
D45, E14, 1 x 40W  
↗ 91826/74









1-2

## Shadow

transparent  
glass

1.94834/00 

‡ 200mm ↔  
→ ø 200mm  
C35, E14, 1 x 40W



1



## Robin

white alabaster  
glass

1.92900/94 

‡ 300mm ↔  
→ ø 120mm  
A60, E27, 1 x 60W



2





## Wega

chrome  
metal/glass

1.24547/15 

↑ 260mm ↔

→ ø 95mm

A60, E27, 1 x 60W



SEE OTHER VERSIONS  
ON PAGE

79





1 - 2

## Alhambra

chrome/white/transparent  
metal/glass

**1. 92958/75** 

↑ 385mm ↔  
→ ø 140mm  
D45, E14, 1 x 40W



4 004353 182471

**2. 92958/00** 

↑ 385mm ↔  
→ ø 140mm  
D45, E14, 1 x 40W



4 004353 182488

1



2



# TABLE LAMPS





1-2

## Pearl

satin nickel/white alabaster/old copper/champagne  
metal/glass

### 1. 67347/75

↑ 260mm ↔  
→ 200mm ø  
D45, E14, 1 x 40W  
↗ 91749/94



4 004353 967559

### 2. 67347/56

↑ 260mm ↔  
→ 200mm ø  
D45, E14, 1 x 40W  
↗ 91749/83



4 004353 976100





## Lille

satin nickel/chrome/white  
metal/glass

1.92929/77 

‡ 360mm ↔ 330mm

→ 0

C35, E14, 2 x 40W

↗ 98017/05





1-2

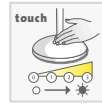

1



2



1-2

## Jaap

black/chrome  
metal/plastic

### 1. G92734/06

↑ 320 - 490mm ↔  
→ 630mm ø

LED integr., 1 x 6W   
1 x 420 lm, 5500 K, **A+**



4 004353 116919

## Bombay

satin nickel  
metal

### 2. G92928/13

↑ 290 - 570mm ↔  
→ 280mm ø

LED integr., 1 x 5,5W   
1 x 305 lm, 6400 K, **A**



4 004353 174612



**LED**  
incl.

incl.  

## Joleen

antique brass  
metal/glass

1. G92974/31 

‡ 420mm ↔ 320mm  
→ 0

LED integr., 1 x 10W   
1 x 700 lm, 3000 K, 







1-2



1



2



1-2

## Nikita

black  
metal/plastic

### 1. G94807/06

↑ 570mm ↔ 205mm  
→ 450mm ø

LED integr., 1 x 5W   
1 x 290 lm, 4100 K, **A+**



4 004353 202865



290  
LUMEN

## Brendan

titanium  
metal

### 2. G94808/11

↑ 460mm ↔  
→ 600mm ø 200mm

LED integr., 1 x 6W   
1 x 680 lm, 4100 K, **A+**



4 004353 202872



680  
LUMEN



1-2

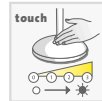

1



2



1-2

## Bradley

black/white  
aluminium/plastic

### 1. G94810/75

‡ 500mm ↔ 210mm  
→ 428mm ø  
LED integr., 1 x 4,5W   
1 x 450 lm, 4000 K, **A+**



4 004353 202896

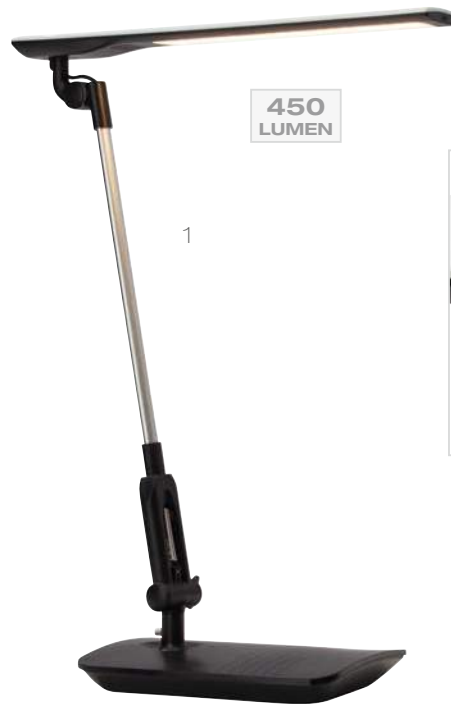

450  
LUMEN

1



## Sheldon

black/white  
metal/plastic

### 3. G94812/75

‡ 530mm ↔  
→ 330mm ø  
LED integr., 1 x 9W   
1 x 715 lm, 4000 K, **A+**



4 004353 202919



715  
LUMEN

2



1-3



1-3



1-3

## Nele

white/black  
metal/plastic

### 1. G94920/05

‡ 625mm ↔ 145mm  
→ 145mm ø  
LED integr., 1 x 5W   
1 x 300 lm, 6000 K, **A**



4 004353 245916

### 2. G94920/06

‡ 625mm ↔ 145mm  
→ 145mm ø  
LED integr., 1 x 5W   
1 x 300 lm, 6000 K, **A**



4 004353 245923



300  
LUMEN



300  
LUMEN

## Karina

black  
metal/plastic

### 1. G94895/06

‡ 650mm ↔  
→ 173mm ø  
LED integr., 1 x 4,5W   
1 x 480 lm, 3000 K, **A+**



4 004353 227455



480  
LUMEN





1-2



1-2



1-2

## Glenn

white/black  
metal/plastic

### 1. G94871/05

‡ 550mm ↔150mm  
→150mm ø  
LED integr., 1 x 5W  
1 x 300 lm, 2800-6500 K, **A**



4 004353 218736

### 2. G94871/06

‡ 550mm ↔150mm  
→150mm ø  
LED integr., 1 x 5W  
1 x 300 lm, 2800-6500 K, **A**



4 004353 220739



300  
LUMEN

1



300  
LUMEN

2

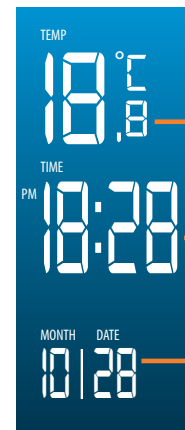

LCD Screen

Thermometer

Time

Date



cold white



warm white



neutral white





## Holger

chrome/grey  
metal/plastic

### 1. G92941/22

↑ 470mm ↔  
→ 500mm ø

LED integr., 1 x 4,3W   
1 x 240 lm, 3000 K, 







## Clap

chrome  
metal

1. G94909/15 

‡ 450mm ↔  
→ 0

LED integr., 1 x 3W   
1 x 240 lm, 3000 K, 





## Perfect

satin nickel/white  
metal/glass

### 1. G17449/13

↑ 440mm ↔

→ 270mm ø 180mm

LED integr., 1 x 5W 

1 x 400 lm, 2700 K, 

↗ 98210/05



1



400  
LUMEN

SEE OTHER VERSIONS  
ON PAGE  
499



# TABLE LAMPS







1 - 4



1 - 4



1 - 4

## Katrina

green/white/black/titanium  
metal/plastic

### 1. G94816/04

‡ 200 - 440mm ↔  
→ 400mm ø 115mm  
LED integr., 1 x 7,26W   
1 x 607 lm, 2700 K, **A+**



4

### 2. G94816/05

‡ 200 - 440mm ↔  
→ 400mm ø 115mm  
LED integr., 1 x 7,26W   
1 x 607 lm, 2700 K, **A+**



4

### 3. G94816/06

‡ 200 - 440mm ↔  
→ 400mm ø 115mm  
LED integr., 1 x 7,26W   
1 x 607 lm, 2700 K, **A+**



4

### 4. G94816/11

‡ 200 - 440mm ↔  
→ 400mm ø 115mm  
LED integr., 1 x 7,26W   
1 x 607 lm, 2700 K, **A+**



4



607  
LUMEN

‡200 - 440 mm



607  
LUMEN

‡200 - 440 mm



607  
LUMEN

‡200 - 440 mm



607  
LUMEN

‡200 - 440 mm

# TABLE LAMPS





1-5



1-5





1-5

## Anthony

satin nickel/blue/green/  
white/titanium/pink  
metal/plastic

### 1. G92935/03



‡ 400mm ↔  
→ 280mm ø 160mm  
LED integr., 1 x 2,4W   
1 x 200 lm, 3000 K, 



4 004353 175459



### 2. G92935/04



‡ 400mm ↔  
→ 280mm ø 160mm  
LED integr., 1 x 2,4W   
1 x 200 lm, 3000 K, 



4 004353 175466



### 3. G92935/05



‡ 400mm ↔  
→ 280mm ø 160mm  
LED integr., 1 x 2,4W   
1 x 200 lm, 3000 K, 



4 004353 175473



### 4. G92935/11



‡ 400mm ↔  
→ 280mm ø 160mm  
LED integr., 1 x 2,4W   
1 x 200 lm, 3000 K, 

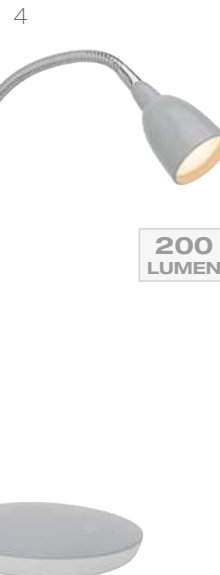

4 004353 175480



### 5. G92935/17

‡ 400mm ↔  
→ 280mm ø 160mm  
LED integr., 1 x 2,4W   
1 x 200 lm, 3000 K, 



4 004353 175497





1-2



1-2



1-2

## Anthony

satin nickel/white/titanium  
metal/plastic

### 1. G92936/05

↑ 380mm ↔

→ 380mm ø

LED integr., 1 x 2,4W 

1 x 200 lm, 3000 K, 





4 004353 175503

### 2. G92936/11

↑ 380mm ↔

→ 380mm ø

LED integr., 1 x 2,4W 

1 x 200 lm, 3000 K, 



4 004353 175510

200  
LUMEN



1



200  
LUMEN

2





1-5



1-5



1-5

## Venedig

white/black/titanium/red/blue  
metal/plastic

### 1. G92926/05

‡ 236 - 360mm ↔  
→ ø 120mm  
LED integr., 1 x 3,3W   
1 x 220 lm, 3000 K, **A+**



4 004353 174537

### 2. G92926/06

‡ 236 - 360mm ↔  
→ ø 120mm  
LED integr., 1 x 3,3W   
1 x 220 lm, 3000 K, **A+**



4 004353 174544

### 3. G92926/11

‡ 236 - 360mm ↔  
→ ø 120mm  
LED integr., 1 x 3,3W   
1 x 220 lm, 3000 K, **A+**



4 004353 174551

### 4. G92926/01

‡ 236 - 360mm ↔  
→ ø 120mm  
LED integr., 1 x 3,3W   
1 x 220 lm, 3000 K, **A+**



4 004353 174513

### 5. G92926/03

‡ 236 - 360mm ↔  
→ ø 120mm  
LED integr., 1 x 3,3W   
1 x 220 lm, 3000 K, **A+**



4 004353 174520

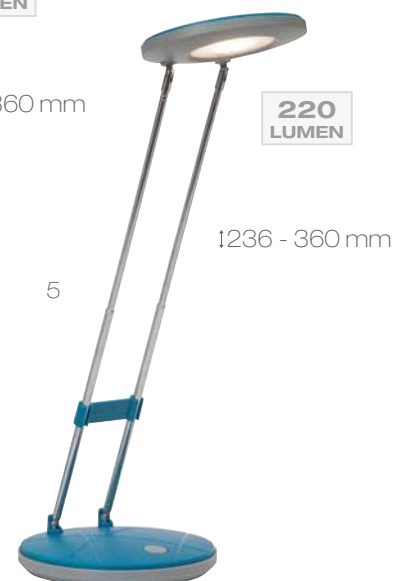



# TABLE LAMPS





1-2



1-2





1-2

## Leo

white/black  
metal/plastic



### 1. G24801A05

‡ 110mm ↔  
→ 170mm ø 60mm  
LED, GU10, 1 x 3W   
1 x 270 lm, 3000 K, 



4 004353 131837

### 2. G24801A06

‡ 110mm ↔  
→ 170mm ø 60mm  
LED, GU10, 1 x 3W   
1 x 270 lm, 3000 K, 



4 004353 131844



1

270  
LUMEN



2

270  
LUMEN

# TABLE LAMPS







1-2



1-2

## Octavia

chrome/white/black  
metal

### 1. 92708/75

‡ 475 - 800mm ↔  
→ 500mm ø 210mm  
A60, E27, 1 x 40W



4 004353 114601

### 2. 92708/76

‡ 475 - 800mm ↔  
→ 500mm ø 210mm  
A60, E27, 1 x 40W



4 004353 104442



2

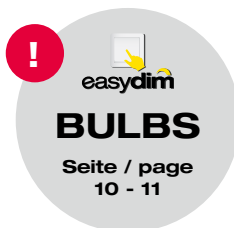

SEE OTHER VERSIONS  
ON PAGE  
**502**

# TABLE LAMPS





1 - 4



1 - 4

## Hobby

red/grey/white/black  
metal

### 1. 10802/01

↑ 700mm ↔  
→ 650mm ø 170mm  
A60, E27, 1 x 40W



4 004353 889066



1

### 2. 10802/11

↑ 700mm ↔  
→ 650mm ø 170mm  
A60, E27, 1 x 40W



4 004353 987168



2

### 3. 10802/05

↑ 700mm ↔  
→ 650mm ø 170mm  
A60, E27, 1 x 40W



4 004353 898532



3

### 4. 10802/06

↑ 700mm ↔  
→ 650mm ø 170mm  
A60, E27, 1 x 40W



4 004353 898549



4



1-3



1-3

## Henry

black/chrome  
metal/plastic

### 1. 92706/06

↑ 500mm ↔  
→ 400mm ø 155mm  
A60, E27, 1 x 28W



### 2. 92706/15

↑ 500mm ↔  
→ 400mm ø 155mm  
A60, E27, 1 x 28W



## Zig Zag

chrome  
metal

### 3. 92728/15

↑ 600mm ↔  
→ 590mm ø 155mm  
D45, E14, 1 x 40W





1

## Bankir

antique brass/white  
metal/wood/glass

1.92679/31 

↑ 335mm ↔260mm

→ 240mm ø

A60, E27, 1 x 60W



4 004353 086199

1





1-3



1-3

## Jan

silver/red/white/black  
metal/plastic

### 1. 92762/01

‡ 520mm ↔  
→ 280mm ø 190mm  
A60, E27, 1 x 40W



4 004353 121593

### 2. 92762/05

‡ 520mm ↔  
→ 280mm ø 190mm  
A60, E27, 1 x 40W



4 004353 121609

### 3. 92762/06

‡ 520mm ↔  
→ 280mm ø 190mm  
A60, E27, 1 x 40W



4 004353 121616

1



2



3





## Jenny

pink/green/orange/titanium/blue  
metal/plastic

### 1. 92604/78

‡ 430mm ↔  
→ ø 150mm  
D45, E14, 1 x 40W



### 2. 92604/04

‡ 430mm ↔  
→ ø 150mm  
D45, E14, 1 x 40W



### 3. 92604/07

‡ 430mm ↔  
→ ø 150mm  
D45, E14, 1 x 40W



### 4. 92604/11

‡ 430mm ↔  
→ ø 150mm  
D45, E14, 1 x 40W



### 5. 92604/03

‡ 430mm ↔  
→ ø 150mm  
D45, E14, 1 x 40W





# TABLE LAMPS







1-4



1-4



1-4

## Pharrell

orange/pink/yellow/green  
metal/plastic

### 1. G94837/07

‡ 310mm ↔  
→ 160mm ø 110mm  
LED integr., 1 x 1,5W   
1 x 90 lm, 3000 K, **A+**



4 004353 210129

### 2. G94837/17

‡ 310mm ↔  
→ 160mm ø 110mm  
LED integr., 1 x 1,5W   
1 x 90 lm, 3000 K, **A+**



4 004353 210136

### 3. G94837/02

‡ 310mm ↔  
→ 160mm ø 110mm  
LED integr., 1 x 1,5W   
1 x 90 lm, 3000 K, **A+**



4 004353 210105

### 4. G94837/04

‡ 310mm ↔  
→ 160mm ø 110mm  
LED integr., 1 x 1,5W   
1 x 90 lm, 3000 K, **A+**



4 004353 210112



1

90  
LUMEN



2

90  
LUMEN



3

90  
LUMEN



4

90  
LUMEN

# TABLE LAMPS





1-3



1-3

## Borgo

white/blue/green/pink  
metal/plastic

### 1. 92931/73

‡ 335mm ↔ 230mm  
→ 140mm ø  
TCG-SE, E27, 1 x 11W



4 004353 175282

### 2. 92931/74

‡ 335mm ↔ 230mm  
→ 140mm ø  
TCG-SE, E27, 1 x 11W



4 004353 175299

### 3. 92931/78

‡ 335mm ↔ 230mm  
→ 140mm ø  
TCG-SE, E27, 1 x 11W



4 004353 175312

1



2



3





1 - 4



1 - 4

## Junior

black/white/multi-coloured/titanium  
metal/plastic

### 1. 99122/06

‡ 300mm ↔  
→ ø 130mm  
R80, E27, 1 x 40W



4 004353 563492

### 2. 99122/05

‡ 300mm ↔  
→ ø 130mm  
R80, E27, 1 x 40W



4 004353 037412

### 3. 99122/03

‡ 300mm ↔  
→ ø 130mm  
R80, E27, 1 x 40W



4 004353 919091

### 4. 99122/11

‡ 300mm ↔  
→ ø 130mm  
R80, E27, 1 x 40W



4 004353 967504



1



2



3



4



1-5



1-5

## Flex

white/black/titanium/blue/multi-coloured  
metal/plastic

### 1. 24705T05

↑ 520mm ↔  
→ 230mm ø 62mm  
R50, E14, 1 x 40W



1

### 2. 24705T06

↑ 520mm ↔  
→ 230mm ø 62mm  
R50, E14, 1 x 40W



2

### 3. 24705/11

↑ 520mm ↔  
→ 230mm ø 62mm  
R50, E14, 1 x 40W



3

### 4. 24705/37

↑ 520mm ↔  
→ 230mm ø 62mm  
R50, E14, 1 x 40W



4

### 5. 24705/72

↑ 520mm ↔  
→ 230mm ø 62mm  
R50, E14, 1 x 40W



5



# TABLE LAMPS







# RECESSES



**LED**  
incl.

1 - 2

## Laureen

white  
metal/plastic

### 1. G94660/05

↑                    ↔  
→80mm    ø 170mm  
LED integr., 1 x 12W   
1 x 880 lm, 3000 K, **A**



1

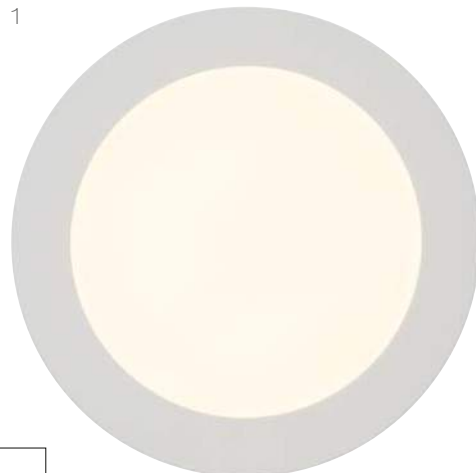

**880**  
LUMEN

### 2. G94661/05

↑                    ↔  
→80mm    ø 225mm  
LED integr., 1 x 18W   
1 x 1490 lm, 3000 K, **A**



2

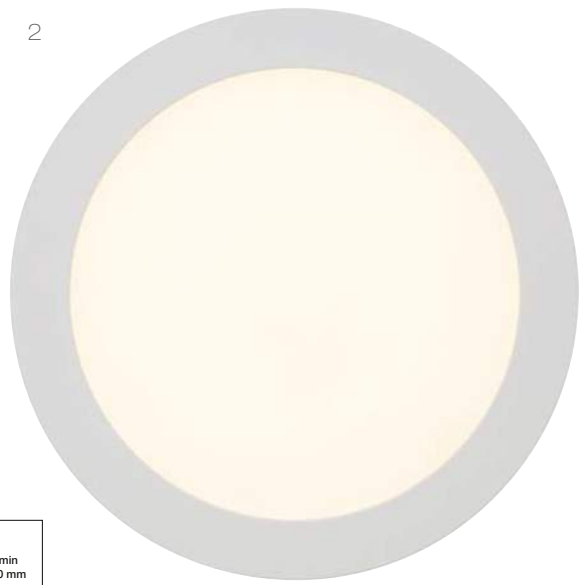

**1490**  
LUMEN

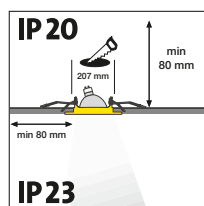
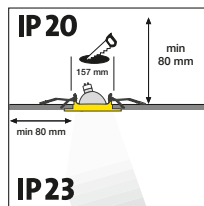



**LED**  
incl.

1 - 2

## Kolja



white  
metal/plastic

### 1. G94658/05

↑ ↔170mm  
→80mm ∅  
LED integr., 1 x 12W   
1 x 970 lm, 3000 K, 



### 2. G94659/05

↑ ↔225mm  
→80mm ∅  
LED integr., 1 x 18W   
1 x 1500 lm, 3000 K, 



1



**970**  
LUMEN

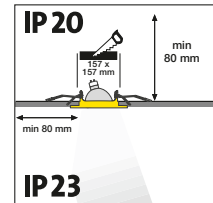

2

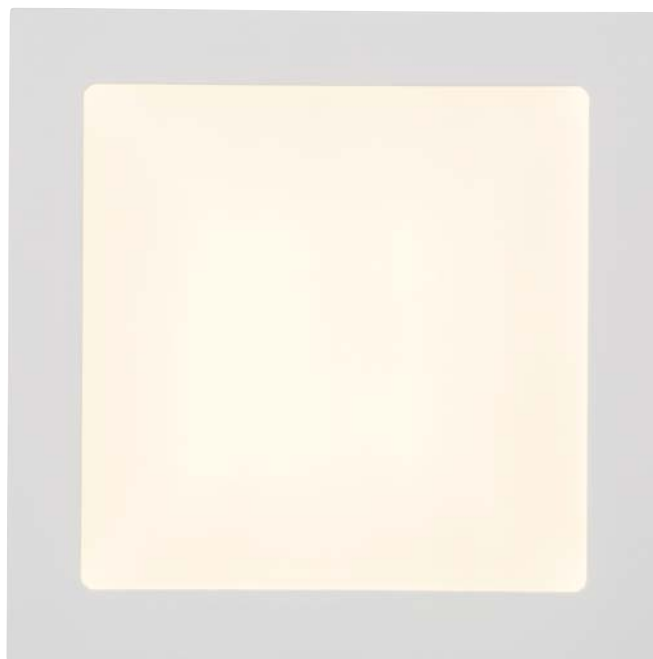

**1500**  
LUMEN

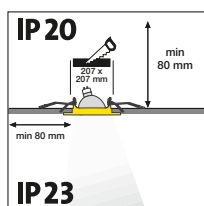

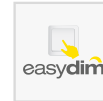



## Honor

satin nickel  
metal

### 1. G94689A13

↑ ↔  
→ ø 88mm  
LED, GU10, 3 x 5W   
3 x 400 lm, 3000 K,   
↗ 96701B05



1

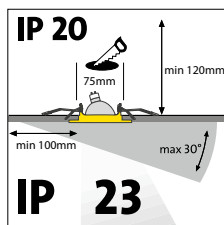

1200  
LUMEN

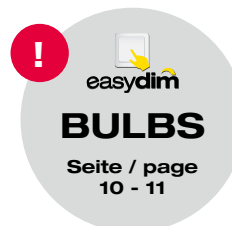

**RECESS**



**LED**  
incl.



1 - 4

1 - 4

## Easy Clip

white/satin nickel  
metal

### 1. G94649/05

↓      ↔  
→100mm ø 84mm  
LED, GU10, 1 x 5W  
1 x 350 lm, 2700 K, **A+**  
96691B11



4 004353 189128

### 2. G94649/13

↓      ↔  
→100mm ø 84mm  
LED, GU10, 1 x 5W  
1 x 350 lm, 2700 K, **A+**  
96691B11



4 004353 189142

### 3. G94650/05

↓      ↔  
→100mm ø 84mm  
LED, GU10, 3 x 5W  
3 x 350 lm, 2700 K, **A+**  
96691B11



4 004353 189159

### 4. G94650/13

↓      ↔  
→100mm ø 84mm  
LED, GU10, 3 x 5W  
3 x 350 lm, 2700 K, **A+**  
96691B11



4 004353 189173

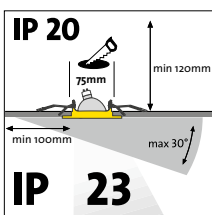

**LED**  
incl.  
1 - 4



## Easy Clip

white/satin nickel  
metal

### 1. G94651/05

↑ ↔ 82mm  
→ 100mm ø  
LED, GU10, 1 x 5W   
1 x 350 lm, 2700 K, **A+**  
96691B11



### 2. G94651/13

↑ ↔ 82mm  
→ 100mm ø  
LED, GU10, 1 x 5W   
1 x 350 lm, 2700 K, **A+**  
96691B11



### 3. G94652/05

↑ ↔ 82mm  
→ 100mm ø  
LED, GU10, 3 x 5W   
3 x 350 lm, 2700 K, **A+**  
96691B11



1050 LUMEN

### 4. G94652/13

↑ ↔ 82mm  
→ 100mm ø  
LED, GU10, 3 x 5W   
3 x 350 lm, 2700 K, **A+**  
96691B11



1050 LUMEN

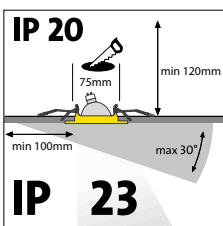



**LED**  
incl.

1-2

**IP44**  

1-2

## Taniel

white/satin nickel  
metal/plastic

### 1. G94667/05

↑                    ↔  
→                    ∅ 75mm  
LED integr., 3 x 5W   
3 x 400 lm, 3000K, **A+** 



4 004353 232008

1



**1200**  
LUMEN

### 2. G94667/13

↑                    ↔  
→                    ∅ 75mm  
LED integr., 3 x 5W   
3 x 400 lm, 3000K, **A+** 



4 004353 235900

2



**1200**  
LUMEN

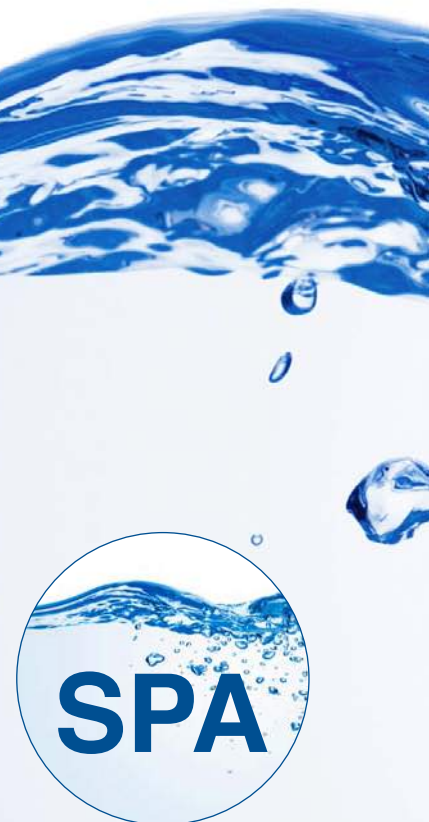
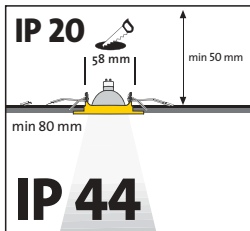

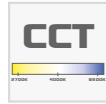

## Tanel

white  
metal/plastic

1. **G94668/05** 

↑                    ↔  
→                    ∅ 85mm  
LED integr., 3 x 5W   
3 x 300 lm, 2700-6500 K, 

900  
LUMEN



4 004353 232015

1

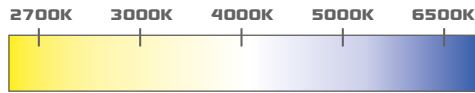
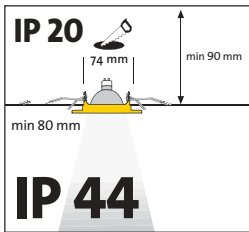



**LED**  
incl.



1-2

1-2

## Franca

white/satin nickel  
metal/plastic

### 1. G94673/05

↑ ↔  
→ ø 85mm  
LED, GU10, 3 x 4W  
3 x 350 lm, 3000 K, **A+**



1050  
LUMEN



### 2. G94673/13

↑ ↔  
→ ø 85mm  
LED, GU10, 3 x 4W  
3 x 350 lm, 3000 K, **A+**



1050  
LUMEN

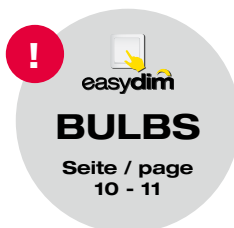
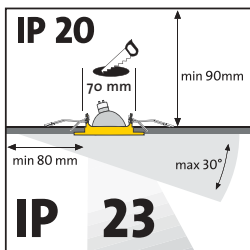

**RECESS**



**LED**  
incl.  
1 - 4



1 - 4

## Felizia LED

white/satin nickel  
metal

### 1. G94677/05

↓            ↔  
→            ø 78mm  
LED, GU10, 1 x 3W  
1 x 250 lm, 3000 K, **A++**



### 2. G94677/13

↓            ↔  
→            ø 78mm  
LED, GU10, 1 x 3W  
1 x 250 lm, 3000 K, **A++**



### 3. G94687/05

↓            ↔  
→            ø 78mm  
LED, GU10, 3 x 3W  
3 x 250 lm, 3000 K, **A++**



### 4. G94687/13

↓            ↔  
→            ø 78mm  
LED, GU10, 3 x 3W  
3 x 250 lm, 3000 K, **A++**

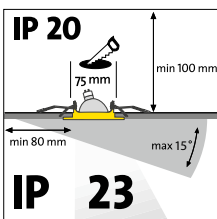

**LED**  
incl.

1 - 4

## Felizia LED

white/satin nickel  
metal

### 1. G94676/05

↑ ↔  
→ ø 78mm  
LED, GU10, 1 x 3W   
1 x 250 lm, 3000 K, **A++**



### 2. G94676/13

↑ ↔  
→ ø 78mm  
LED, GU10, 1 x 3W   
1 x 250 lm, 3000 K, **A++**



### 3. G94686/05

↑ ↔  
→ ø 78mm  
LED, GU10, 3 x 3W   
3 x 250 lm, 3000 K, **A++**



### 4. G94686/13

↑ ↔  
→ ø 78mm  
LED, GU10, 3 x 3W   
3 x 250 lm, 3000 K, **A++**

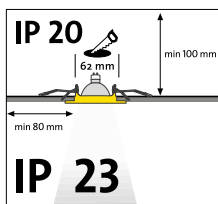

**LED**  
incl.



1 - 4

1 - 4

## Classic LED

white/satin nickel  
metal

### 1. G94675/05

↑ ↔  
→ ø 82mm  
LED, GU10, 1 x 3W   
1 x 250 lm, 3000 K, **A++**



1



250  
LUMEN

2



250  
LUMEN

### 2. G94675/13

↑ ↔  
→ ø 82mm  
LED, GU10, 1 x 3W   
1 x 250 lm, 3000 K, **A++**



### 3. G94685/05

↑ ↔  
→ ø 82mm  
LED, GU10, 3 x 3W   
3 x 250 lm, 3000 K, **A++**



3



750  
LUMEN

### 4. G94685/13

↑ ↔  
→ ø 82mm  
LED, GU10, 3 x 3W   
3 x 250 lm, 3000 K, **A++**



4



750  
LUMEN

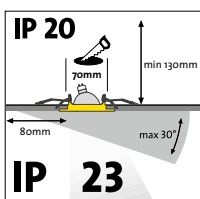



**LED**  
incl.

1 - 4

## Classic LED

white/satin nickel  
metal

### 1. G94674/05

↑ ↔  
→ ø 80mm  
LED, GU10, 1 x 3W   
1 x 250 lm, 3000 K, **A++**



250  
LUMEN



250  
LUMEN



### 2. G94674/13

↑ ↔  
→ ø 80mm  
LED, GU10, 1 x 3W   
1 x 250 lm, 3000 K, **A++**



### 3. G94684/05

↑ ↔  
→ ø 80mm  
LED, GU10, 3 x 3W   
3 x 250 lm, 3000 K, **A++**



750  
LUMEN



### 4. G94684/13

↑ ↔  
→ ø 80mm  
LED, GU10, 3 x 3W   
3 x 250 lm, 3000 K, **A++**



750  
LUMEN

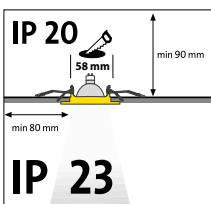

**LED**  
incl.  
1 - 4

set of  
**10**  
1 - 4

**IP44**  
1 - 4

## Asta 30

high-grade steel/white metal/glass

### 1. G02893/82

↑ 30mm ↔ 30mm  
→ ∅  
LED integr., 10 x 0,07W ☑  
↗ 92407/00, 92408/00,  
92572/00, G92552/82,  
G92552A82

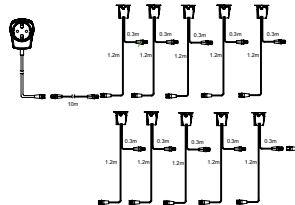
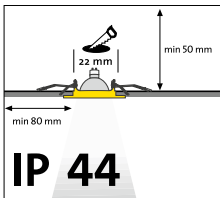

1



2



## Cosa 15

high-grade steel/blue/white/warm white metal/glass

### 2. G03090/73

↑ ↔  
→ ∅ 15mm  
LED integr., 10 x 0,07W ☑  
↗ 92407/00, 92408/00,  
92572/00, G92549/73,  
G92549A73

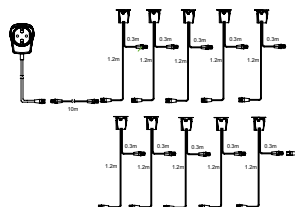
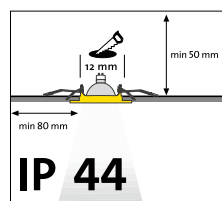

3

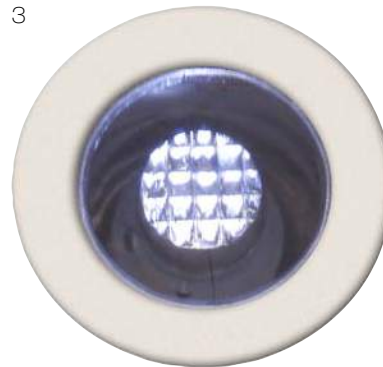

### 3. G03090/82

↑ ↔  
→ ∅ 15mm  
LED integr., 10 x 0,07W ☑  
↗ 92407/00, 92408/00,  
92572/00, G92549/82,  
G92549A82



### 4. G03090/75

↑ ↔  
→ ∅ 15mm  
LED integr., 10 x 0,07W ☑  
↗ 92407/00, 92408/00,  
92572/00, G92549/75,  
G92549A75



4





**LED**  
incl.

1 - 4

set of  
**10**

1 - 4

**IP44**

1 - 4

## Cosa 30

high-grade steel/warm-white/blue/white  
metal/glass

### 1. G03093/75

↓ ↔  
→ ø 30mm  
LED integr., 10 x 0,07W ☑  
↗ 92407/00, 92408/00,  
92572/00, G92550/75,  
G92550A75



1



2



### 2. G03093/73

↓ ↔  
→ ø 30mm  
LED integr., 10 x 0,07W ☑  
↗ 92407/00, G92550A73,  
92408/00, G92550/73,  
92572/00



3



### 3. G03093/82

↓ ↔  
→ ø 30mm  
LED integr., 10 x 0,07W ☑  
↗ 92407/00, 92408/00,  
92572/00, G92550/82,  
G92550A82

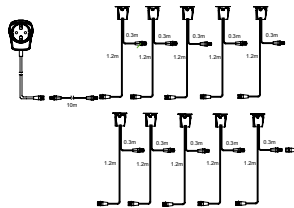
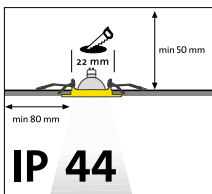

## Cosa 45

high-grade steel/warm-white  
metal

### 4. G03094/75

↓ ↔  
→ ø 45mm  
LED integr., 10 x 0,42W ☑  
↗ 92572/00



4

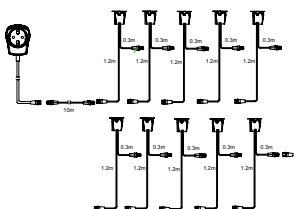
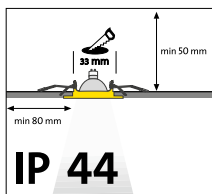



## Lawina

chrome  
aluminium/pastic

1. 94669/15 

↑            ↔  
→            ø 85mm  
QPAR51, GU10, 1 x 28W

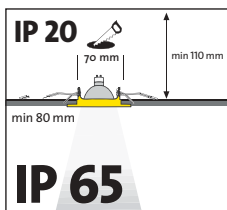







KIDS



1-3



1



2



3

## Birds

multi-coloured  
metal/plastic

### 1. G56034/72

↑ 110mm ↔  
→ 145mm ø 310mm  
LED, GU10, 3 x 3W   
3 x 250 lm, 3000 K, **A++**



### 2. G56047/72

↑ 109mm ↔  
→ ø 70mm  
LED integr., 2 x 0,06W



### 3. G56048/72

↑ 325mm ↔  
→ ø 130mm  
LED integr., 1 x 0,72W   
1 x 60 lm, 3000 K, **A++**



750  
LUMEN



2



3

60  
LUMEN





1, 3



2



1, 3

## Birds

multi-coloured  
metal/textile/plastic/paper

### 1. 56070/72

‡ 1000mm ↔  
→ ø 400mm  
A60, E27, 1 x 60W



4 004353 190476

### 2. 92603/80

‡ 1450mm ↔ 180mm  
→ 180mm ø  
C35, E14, 2 x 40W  
D45, E14, 2 x 40W



4 004353 180712

### 3. 56099P72

‡ ↔  
→ ø 300mm  
A60, E27, 1 x 60W



4 004353 190360



1



3



2

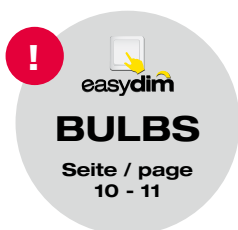



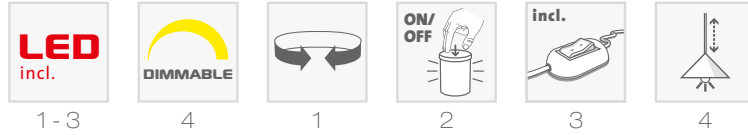

## Princess

pink  
metal/plastic/paper

### 1. G55934/17

↑ 110mm ↔  
→ 145mm ø 310mm  
LED, GU10, 3 x 3W   
3 x 250 lm, 3000 K, **A++**



### 2. G55947/17

↑ 109mm ↔  
→ ø 70mm  
LED integr., 2 x 0,06W



750  
LUMEN



### 3. G55948/17

↑ 325mm ↔  
→ ø 130mm  
LED integr., 1 x 0,72W   
1 x 60 lm, 3000 K, **A++**



### 4. 55999P17

↑ ↔  
→ ø 300mm  
A60, E27, 1 x 60W



60  
LUMEN



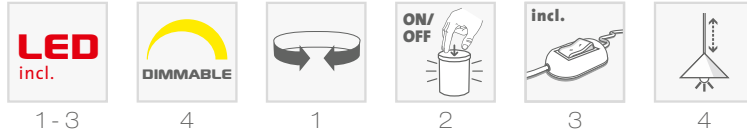

## Soccer

green/black/white  
metal/plastic/paper

### 1. G56234/74

↑ 110mm ↔  
→ 145mm ø 310mm  
LED, GU10, 3 x 3W   
3 x 250 lm, 3000 K, **A++**



750  
LUMEN



### 2. G56247/74

↑ 109mm ↔  
→ ø 70mm  
LED integr., 2 x 0,06W



2

### 3. G56248/74

↑ 325mm ↔  
→ ø 130mm  
LED integr., 1 x 0,72W   
1 x 60 lm, 3000 K, **A++**



60  
LUMEN

3

### 4. 56299P74

↑ ↔  
→ ø 300mm  
A60, E27, 1 x 60W

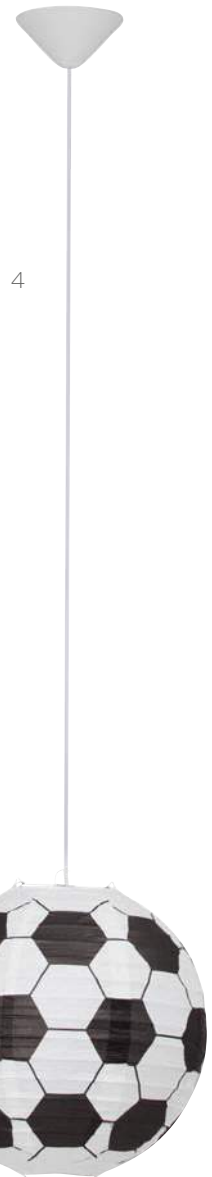

4









# CONCEPTS



#### SOFTLINE LED PANELS

LED Panelleuchten sind eine hervorragende Wahl für Ihre Wohnraumbelichtung

Mit einem umfangreichen Sortiment sind sie für jeden Raum geeignet.

Merkmale und Vorteile von LED Panelleuchten:

- ▶ Sehr flache Module, nur 7mm dick
- ▶ Modernes Design
- ▶ Gleichmäßige Lichtverteilung
- ▶ Geringe Wärmeentwicklung
- ▶ Geringer Stromverbrauch
- ▶ Lange Lebensdauer



#### SOFTLINE LED PANELS

LED panel lights are a superb choice for your home lighting.

They are suitable for any room with their extensive range.

LED panel light features and advantages:

- ▶ Very flat module, just 7 mm thick
- ▶ Modern design
- ▶ Even light distribution
- ▶ Low heat build-up
- ▶ Low power consumption
- ▶ Long lifetime



#### SOFTLINE LED PANELS

Les panneaux lumineux à LED représentent un excellent choix pour l'éclairage de votre logement

Grâce à une gamme complète, ils sont adaptés à chaque espace.

Caractéristiques et avantages des panneaux lumineux à LED:

- ▶ Module très plat, seulement 7 mm d'épaisseur
- ▶ Design moderne
- ▶ Répartition homogène de la lumière
- ▶ Faible production thermique
- ▶ Faible consommation d'électricité
- ▶ Longue durée de vie



#### PANNELLI A LED SOFTLINE

Le lampade a pannelli LED sono una scelta eccezionale per l'illuminazione del vostro ambiente abitativo.

Con un assortimento completo sono perfette per ogni stanza.

Caratteristiche e vantaggi delle lampade a pannello LED:

- ▶ Moduli molto piatti, spessi solo 7mm
- ▶ Design moderno
- ▶ Distribuzione uniforme della luce
- ▶ Bassa produzione di calore
- ▶ Basso consumo di corrente
- ▶ Lunga durata



# Softline Concept Overview



**name:** Pluto  
**article no:** G30510/13  
**page:** 14



**name:** Pluto  
**article no:** G30534/13  
**page:** 14



**name:** Pluto  
**article no:** G30513/13  
**page:** 14



**name:** Pluto  
**article no:** G30535/13  
**page:** 14



**name:** Pluto  
**article no:** G30532/13  
**page:** 14



**name:** Pluto  
**article no:** G30506/13  
**page:** 14



**name:** Pluto  
**article no:** G30510/15  
**page:** 15



**name:** Pluto  
**article no:** G30534/15  
**page:** 15



**name:** Pluto  
**article no:** G30513/15  
**page:** 15



**name:** Pluto  
**article no:** G30532/15  
**page:** 15



**name:** Pluto  
**article no:** G30506/15  
**page:** 15



**name:** Uranus  
**article no:** G33810/13  
**page:** 16



**name:** Uranus  
**article no:** G33813/13  
**page:** 16



**name:** Uranus  
**article no:** G33816/13  
**page:** 16



**name:** Uranus  
**article no:** G33835/13  
**page:** 16



**name:** Uranus  
**article no:** G33832/13  
**page:** 17



**name:** Uranus  
**article no:** G33806/13  
**page:** 17



**name:** Uranus  
**article no:** G33804/13  
**page:** 17



**name:** Uranus  
**article no:** G33810/15  
**page:** 18



**name:** Uranus  
**article no:** G33813/15  
**page:** 18



## Softline Concept Overview



**name:** Uranus  
**article no:** G33816/15  
**page:** 18



**name:** Uranus  
**article no:** G33832/15  
**page:** 18



**name:** Uranus  
**article no:** G33806/15  
**page:** 18

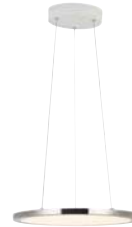

**name:** Smooth  
**article no:** G20870/13  
**page:** 288



**name:** Smooth  
**article no:** G20871/05  
**page:** 288



**name:** Smooth  
**article no:** G20872/05  
**page:** 289



**name:** Smooth  
**article no:** G20873/05  
**page:** 289



**name:** Pluto  
**article no:** G30586/13  
**page:** 360



**name:** Pluto  
**article no:** G30596/13  
**page:** 360



**name:** Uranus  
**article no:** G33896/13  
**page:** 360



**name:** Magellan  
**article no:** G29091/15  
**page:** 362



**name:** Magellan  
**article no:** G29092/15  
**page:** 362



**name:** Magellan  
**article no:** G29093/15  
**page:** 362



**name:** Magellan  
**article no:** G29094/15  
**page:** 362



**name:** Neptun  
**article no:** G94487/15  
**page:** 363



**name:** Neptun  
**article no:** G94486/15  
**page:** 363



**name:** Neptun  
**article no:** G94485/15  
**page:** 363



**name:** Ceres  
**article no:** G94460/13  
**page:** 364



**name:** Ceres  
**article no:** G94460/05  
**page:** 364



**name:** Ceres  
**article no:** G94461/13  
**page:** 364





## Softline Concept Overview



**name:** Ceres  
**article no:** G94461/05  
**page:** 364



**name:** Ceres  
**article no:** G94498/13  
**page:** 365



**name:** Ceres  
**article no:** G94498/05  
**page:** 365



**name:** Ceres  
**article no:** G94462/05  
**page:** 366



**name:** Ceres  
**article no:** G94462/13  
**page:** 366



**name:** Ceres  
**article no:** G94463/05  
**page:** 366



**name:** Ceres  
**article no:** G94463/13  
**page:** 366



**name:** Ceres  
**article no:** G94493/13  
**page:** 367



**name:** Ceres  
**article no:** G94493/05  
**page:** 367



**name:** Ceres  
**article no:** G94464/13  
**page:** 367



**name:** Ceres  
**article no:** G94464/05  
**page:** 367



**name:** Smooth  
**article no:** G20880/05  
**page:** 368



**name:** Smooth  
**article no:** G20881/13  
**page:** 368



**name:** Smooth  
**article no:** G20882/05  
**page:** 368



**name:** Smooth  
**article no:** G20883/13  
**page:** 368



**name:** Smooth  
**article no:** G20884/13  
**page:** 369



**name:** Smooth  
**article no:** G20885/05  
**page:** 369



**name:** Smooth  
**article no:** G20886/13  
**page:** 369



**name:** Smooth  
**article no:** G20887/05  
**page:** 369



**name:** Smooth  
**article no:** G20888/05  
**page:** 370



# Softline Concept Overview



**name:** Flat  
**article no:** G94395/05  
**page:** 371

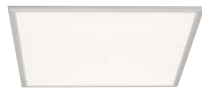

**name:** Flat  
**article no:** G94396/05  
**page:** 371



**name:** Flat  
**article no:** G94397/05  
**page:** 371



**name:** Katalina  
**article no:** G94258/05  
**page:** 372



**name:** Katalina  
**article no:** G94259/05  
**page:** 372



**name:** Jarno  
**article no:** G94256/05  
**page:** 372



**name:** Jarno  
**article no:** G94257/05  
**page:** 372



**name:** Babett  
**article no:** G94254/05  
**page:** 373



**name:** Babett  
**article no:** G94255/05  
**page:** 373



**name:** Tizian  
**article no:** G94252/05  
**page:** 373



**name:** Doors Round  
**article no:** G19191/15  
**page:** 374



**name:** Doors Round  
**article no:** G19192/15  
**page:** 374



**name:** Doors Round  
**article no:** G19193/15  
**page:** 374



**name:** Doors Round  
**article no:** G19194/15  
**page:** 374



**name:** Doors Round  
**article no:** G19195/15  
**page:** 374



**name:** Doors Square  
**article no:** G16291/13  
**page:** 375



**name:** Doors Square  
**article no:** G16292/13  
**page:** 375



**name:** Doors Square  
**article no:** G16293/13  
**page:** 375



**name:** Doors Square  
**article no:** G16294/13  
**page:** 375



**name:** Doors Square  
**article no:** G16295/13  
**page:** 375



# Softline Concept Overview



**name:** Samurai  
**article no:** G15591/13  
**page:** 376



**name:** Samurai  
**article no:** G15592/13  
**page:** 376



**name:** Samurai  
**article no:** G15593/13  
**page:** 376



**name:** Samurai  
**article no:** G15594/13  
**page:** 376



**name:** Palin  
**article no:** G98808/15  
**page:** 426



**name:** Pluto  
**article no:** G30558/13  
**page:** 480



**name:** Laureen  
**article no:** G94660/05  
**page:** 592



**name:** Laureen  
**article no:** G94661/05  
**page:** 592



**name:** Kolja  
**article no:** G94658/05  
**page:** 593



**name:** Kolja  
**article no:** G94659/05  
**page:** 593



**name:** Tanel  
**article no:** G94668/05  
**page:** 599





Mit **BRILLIANCE** in eine glamouröse Welt eintreten.

**EIN EXZELLENTER AUFTRITT DURCH:**

- ▶ extravagantes Design für ein exklusives Wohnambiente
- ▶ harmonische Farbkonzepte
- ▶ attraktive Lichteffekte
- ▶ hohe Verarbeitungsqualität
- ▶ raffinierte Details erzeugen phänomenalen Lichtglanz



Step into a glamorous world with **BRILLIANCE**.

**EXCELLENT APPEARANCE WITH:**

- ▶ Extravagant design for a unique ambiance
- ▶ Complementary colour schemes
- ▶ Attractive lighting effects
- ▶ High quality craftsmanship
- ▶ Refined details create phenomenal luminescence



Pénétrez dans un univers glamour avec **BRILLIANCE**.

**UNE ESTHÉTIQUE IDÉALE GRÂCE À:**

- ▶ un design original, pour créer des ambiances exclusives
- ▶ des concepts de couleurs harmonieux
- ▶ des effets lumineux attrayants
- ▶ la qualité haut de gamme des finitions
- ▶ des détails raffinés qui créent une brillance lumineuse unique



Entrate in un mondo glamour, con **BRILLIANCE**.

**UN EFFETTO ECCELLENTE, GRAZIE A:**

- ▶ design stravagante per un ambiente living esclusivo
- ▶ concetti di colore armonici
- ▶ attraenti effetti luce
- ▶ lavorazione di alta qualità
- ▶ dettagli raffinati creano una luce dalla brillantezza fenomenale

## Brilliance Concept Overview



**name:** Pacome  
**article no:** G35795/15  
**page:** 42



**name:** Pacome  
**article no:** G35713/15  
**page:** 42



**name:** Pacome  
**article no:** G35793/15  
**page:** 42



**name:** Pacome  
**article no:** G35710/15  
**page:** 42



**name:** Aztekas  
**article no:** 24932/75  
**page:** 106



**name:** Aztekas  
**article no:** 24913/75  
**page:** 106



**name:** Aztekas  
**article no:** 24910/75  
**page:** 106



**name:** Aztekas  
**article no:** 24932/85  
**page:** 107



**name:** Aztekas  
**article no:** 24913/85  
**page:** 107



**name:** Aztekas  
**article no:** 24910/85  
**page:** 107



**name:** Brilliance  
**article no:** 93621/15  
**page:** 168



**name:** Brilliance  
**article no:** 93623/15  
**page:** 168



**name:** Brilliance  
**article no:** 93620/15  
**page:** 169



**name:** Brilliance  
**article no:** 93622/15  
**page:** 169



**name:** Brilliance  
**article no:** 93621/29  
**page:** 170



**name:** Brilliance  
**article no:** 93623/29  
**page:** 170



**name:** Brilliance  
**article no:** 93620/29  
**page:** 171



**name:** Brilliance  
**article no:** 93622/29  
**page:** 171











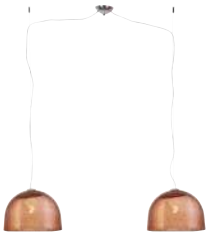











**name:** Sky  
**article no:** 32072/15  
**page:** 172



**name:** Sky  
**article no:** 32070/15  
**page:** 172

## Brilliance Concept Overview

				
name: Sky article no: 32072/29 page: 173	name: Sky article no: 32070/29 page: 173	name: Sky article no: 32049/15 page: 174	name: Sky article no: 32049/29 page: 174	name: Sky article no: 32010/15 page: 175
				
name: Sky article no: 32010/29 page: 175	name: Waterfall article no: 93657/93 page: 176	name: Waterfall article no: 93656/93 page: 176	name: Waterfall article no: 93658/93 page: 176	name: Magic article no: 18093/79 page: 178
				
name: Magic article no: 18095/79 page: 178	name: Magic article no: 18048/79 page: 178	name: Magic article no: 18074/79 page: 180	name: Magic article no: 18075/79 page: 180	name: Magic article no: 18073/79 page: 181
				
name: Magic article no: 18070/79 page: 181	name: Vegas article no: 17674/79 page: 182	name: Vegas article no: 17675/79 page: 182	name: Vegas article no: 17695/79 page: 183	name: Vegas article no: 17693/79 page: 183

## Brilliance Concept Overview



**name:** Vegas  
**article no:** 17690/79  
**page:** 183



**name:** Vegas  
**article no:** 17674/15  
**page:** 184



**name:** Vegas  
**article no:** 17675/15  
**page:** 184



**name:** Vegas  
**article no:** 17695/15  
**page:** 185



**name:** Vegas  
**article no:** 17693/15  
**page:** 185



**name:** Vegas  
**article no:** 17690/15  
**page:** 185



**name:** Noble  
**article no:** 29210/15  
**page:** 186



**name:** Noble  
**article no:** 29230/15  
**page:** 186



**name:** Noble  
**article no:** 29235/15  
**page:** 186



**name:** Noble  
**article no:** 94435/15  
**page:** 186



**name:** Noble  
**article no:** 94436/15  
**page:** 187



**name:** Dubai  
**article no:** 93585/15  
**page:** 188



**name:** Dubai  
**article no:** 93532/15  
**page:** 188



**name:** Dubai  
**article no:** 93627/15  
**page:** 189



**name:** Dubai  
**article no:** 93628/15  
**page:** 189



**name:** Date  
**article no:** 26973/15  
**page:** 190



**name:** Date  
**article no:** 26995/15  
**page:** 190



**name:** Date  
**article no:** 26970/15  
**page:** 191

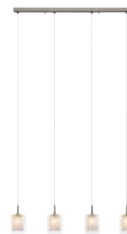

**name:** Date  
**article no:** 26974/15  
**page:** 191



**name:** Date  
**article no:** 26910/15  
**page:** 191



## Brilliance Concept Overview



**name:** Maira  
**article no:** G14776/15  
**page:** 200



**name:** Maira  
**article no:** G14773/15  
**page:** 200



**name:** Maira  
**article no:** G14772/15  
**page:** 200



**name:** Maira  
**article no:** G14710/15  
**page:** 201



**name:** Crush  
**article no:** 94466/15  
**page:** 214



**name:** Crush  
**article no:** 94466/85  
**page:** 214



**name:** Crush  
**article no:** 94467/15  
**page:** 214



**name:** Crush  
**article no:** 94467/85  
**page:** 214



**name:** Aztekas  
**article no:** 24970/85  
**page:** 215



**name:** Aztekas  
**article no:** 24970/75  
**page:** 215



**name:** Aztekas  
**article no:** 24991/75  
**page:** 215



**name:** Aztekas  
**article no:** 24991/85  
**page:** 215

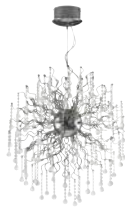

**name:** Nash XL  
**article no:** G93418/15  
**page:** 292

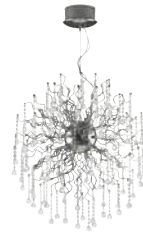

**name:** Nash XXL  
**article no:** G93328/15  
**page:** 293



**name:** Ghost  
**article no:** 93584/15  
**page:** 294



**name:** Bombilla  
**article no:** 93619/15  
**page:** 296



**name:** Bombilla  
**article no:** 93609/15  
**page:** 296



**name:** Joker  
**article no:** 93553/15  
**page:** 297



**name:** Joker  
**article no:** 93554/15  
**page:** 297



**name:** Fantasie  
**article no:** G94438/15  
**page:** 400

## Brilliance Concept Overview



**name:** Fantasie  
**article no:** G94439/15  
**page:** 400



**name:** Larina  
**article no:** G94279/15  
**page:** 401



**name:** Larina  
**article no:** G94280/15  
**page:** 401



**name:** Larina  
**article no:** G94281/15  
**page:** 401



**name:** Alica  
**article no:** G94156/15  
**page:** 402



**name:** Svea  
**article no:** G94155/15  
**page:** 402



**name:** Martino  
**article no:** G94264/15  
**page:** 403



**name:** Martino  
**article no:** G94265/15  
**page:** 403



**name:** Martino  
**article no:** G94266/15  
**page:** 403



**name:** Martino  
**article no:** G94267/15  
**page:** 403



**name:** Fine  
**article no:** G94389/15  
**page:** 404



**name:** Fine  
**article no:** G94390/15  
**page:** 404



**name:** Fine  
**article no:** G94391/15  
**page:** 404



**name:** Rom  
**article no:** 94861/05  
**page:** 540



**name:** Quadri  
**article no:** 94913/15  
**page:** 540



**Mit NEO RETRO zurück in eine stilvolle Zukunft.**

**BESTICHT DURCH:**

- ▶ nostalgische und moderne Elemente vereint für einen zeitgemäßen Wohnstil
- ▶ ungewöhnliche Formen in ausdrucksstarken Designs für individuelles Wohnen
- ▶ die Trendfarbe Kupfer schafft ein modernes Wohnerleben



**Step back in time for a stylish future with NEO RETRO.**

**APTIVATING WITH:**

- ▶ Nostalgic and modern elements combined to create a contemporary style
- ▶ Extraordinary shapes in bold designs for a unique living space
- ▶ The latest colour trend, copper, creates a modern atmosphere



**Avec NEO RETRO, embarquez pour un retour vers le futur tout en élégance**

**SÉDUIT PAR:**

- ▶ ses éléments nostalgiques et modernes à la fois, pour créer un intérieur au style intemporel
- ▶ des lignes originales et des designs expressifs, pour une décoration personnalisée
- ▶ la couleur cuivre tendance, qui apporte une touche de modernité



**Ritorno a un futuro di gran stile, con NEO RETRO.**

**SEDUCE GRAZIE A:**

- ▶ elementi nostalgici e moderni uniti per uno stile living contemporaneo
- ▶ forme insolite in design fortemente espressivi, per un ambiente living individuale
- ▶ il color rame, di grande tendenza, crea un'esperienza moderna per la propria casa

## Neo Retro Concept Overview



**name:** Dalma  
**article no:** 21034/76  
**page:** 112



**name:** Dalma  
**article no:** 21013/76  
**page:** 112



**name:** Dalma  
**article no:** 21010/76  
**page:** 112



**name:** Dalma  
**article no:** 21096/76  
**page:** 113



**name:** Dalma  
**article no:** 21094/76  
**page:** 113



**name:** Billy  
**article no:** 94447/76  
**page:** 240



**name:** Billy  
**article no:** 93677/76  
**page:** 240



**name:** Synergy  
**article no:** 93592/29  
**page:** 241



**name:** Synergy  
**article no:** 93593/76  
**page:** 241

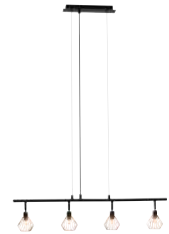

**name:** Dalma  
**article no:** 21074/76  
**page:** 242



**name:** Dalma  
**article no:** 21059/76  
**page:** 242



**name:** Dalma  
**article no:** 21048/76  
**page:** 242



**name:** Dalma  
**article no:** 93478/29  
**page:** 243



**name:** Route 66  
**article no:** 94863/76  
**page:** 246



**name:** Route 66  
**article no:** 94863/77  
**page:** 246



**name:** Route 66  
**article no:** 94862/76  
**page:** 246



**name:** Route 66  
**article no:** 94862/77  
**page:** 246



**name:** Martu  
**article no:** 22790/15  
**page:** 247



**name:** Martu  
**article no:** 22770/15  
**page:** 247



**name:** Martu  
**article no:** 22710/15  
**page:** 247

## Neo Retro Concept Overview



**name:** Pure  
**article no:** 93557/06  
**page:** 323



**name:** Ancolie  
**article no:** 93674/21  
**page:** 324



**name:** Ancolie  
**article no:** 93674/29  
**page:** 324



**name:** Grace  
**article no:** 93675/13  
**page:** 325



**name:** Grace  
**article no:** 93675/29  
**page:** 325



**name:** Sid  
**article no:** 93676/29  
**page:** 326



**name:** LED Filament Bulbs  
**article no:** 96694A10  
**page:** 326



**name:** LED Filament Bulbs  
**article no:** 96704A10  
**page:** 326



**name:** Salford  
**article no:** 93590/29  
**page:** 327



**name:** Salford  
**article no:** 93590/76  
**page:** 327



**name:** Coppra  
**article no:** 93552/31  
**page:** 328



**name:** Tycho  
**article no:** 93594/76  
**page:** 329



**name:** Coriolis  
**article no:** 93595/76  
**page:** 329



**name:** Hippolyte  
**article no:** 93597/29  
**page:** 330



**name:** Leonid  
**article no:** 93601/06  
**page:** 330



**name:** Feodora  
**article no:** 93611/29  
**page:** 331



**name:** Kago  
**article no:** 93612/29  
**page:** 331



**name:** Salford  
**article no:** 93590/70  
**page:** 332



**name:** Grimsby  
**article no:** 93589/70  
**page:** 332



**name:** Fleetwood  
**article no:** 93588/70  
**page:** 332

## Neo Retro Concept Overview



**name:** Athena  
**article no:** 94427/29  
**page:** 462



**name:** Nereide  
**article no:** 92645/29  
**page:** 505



**name:** Grigory  
**article no:** 94905/76  
**page:** 527



**name:** Home  
**article no:** 94906/76  
**page:** 527



Mit **INDUSTRIAL** zum Fabric-Chic.

**MERKMALE:**

- ▶ Used-Look für einen zwanglosen Auftritt mit großer Wirkung
- ▶ Designs erlauben kontrastreiche Inszenierungen für ein ausgefallenes Ambiente
- ▶ grobe Optik ist perfekt für den extravaganen Einrichtungsstil



Create fabric-chic with **INDUSTRIAL**.

**FEATURES:**

- ▶ "Used" look for a casual appearance with big impact
- ▶ Designs allow for highly contrasting arrangements to create a unique environment
- ▶ Rough appearance is perfect for an extravagant interior design style



Avec **INDUSTRIAL**, mélangez style industriel et élégance.

**CARACTÉRISTIQUES:**

- ▶ un look used pour un style décontracté, qui fait forte impression
- ▶ des designs qui permettent de créer des scènes contrastées et une ambiance originale
- ▶ un aspect brut pour un aménagement au style extravagant



Il fabric chic di **INDUSTRIAL**.

**CARATTERISTICHE:**

- ▶ look usato per un aspetto rilassato di grande effetto
- ▶ i design permettono di creare scene dai grandi contrasti per un ambiente particolare
- ▶ l'aspetto grezzo è perfetto per un arredamento dallo stile stravagante





## Industrial Concept Overview



**name:** Rider  
**article no:** 14932/70  
**page:** 114



**name:** Rider  
**article no:** 14913/70  
**page:** 114



**name:** Rider  
**article no:** 14910/70  
**page:** 114



**name:** Bente  
**article no:** G26334/70  
**page:** 116



**name:** Bente  
**article no:** G26324/70  
**page:** 116



**name:** Bente  
**article no:** G26310/70  
**page:** 116



**name:** Bentli  
**article no:** 26834/76  
**page:** 117



**name:** Bentli  
**article no:** 26824/76  
**page:** 117



**name:** Bentli  
**article no:** 26810/76  
**page:** 117



**name:** Jesper  
**article no:** 23770/70  
**page:** 248



**name:** Jesper  
**article no:** 23771/70  
**page:** 248



**name:** Jesper  
**article no:** 23758/70  
**page:** 249



**name:** Jesper  
**article no:** 23710/70  
**page:** 249



**name:** Jesper  
**article no:** 23749/70  
**page:** 249



**name:** Rings  
**article no:** 94944/70  
**page:** 250



**name:** Rings  
**article no:** 94945/70  
**page:** 250



**name:** Storm  
**article no:** 93651/70  
**page:** 251



**name:** Storm  
**article no:** 93652/70  
**page:** 251



**name:** Inabl  
**article no:** HK12707S06  
**page:** 318



**name:** Inabl  
**article no:** HK12707S05  
**page:** 318

## Industrial Concept Overview



**name:** Pharos  
**article no:** HK13021S13  
**page:** 319



**name:** Salford  
**article no:** 93590/70  
**page:** 332



**name:** Grimsby  
**article no:** 93589/70  
**page:** 332



**name:** Fleetwood  
**article no:** 93588/70  
**page:** 332



**name:** Anouk  
**article no:** 93444/70  
**page:** 334



**name:** Anouk  
**article no:** F-93444/70  
**page:** 334



**name:** Salma  
**article no:** 93616/70  
**page:** 335



**name:** Bente  
**article no:** 93617/70  
**page:** 335



**name:** Rope  
**article no:** 93614/70  
**page:** 336



**name:** Torres  
**article no:** 93615/70  
**page:** 336



**name:** Desert  
**article no:** 93618/02  
**page:** 338



**name:** Desert  
**article no:** 93618/03  
**page:** 338



**name:** Desert  
**article no:** 93618/72  
**page:** 338



**name:** Dirt  
**article no:** 93613/74  
**page:** 339



**name:** Dirt  
**article no:** 93613/55  
**page:** 339



**name:** Frieda  
**article no:** 93630/70  
**page:** 340



**name:** Frieda  
**article no:** 93668/76  
**page:** 340



**name:** Bobbi  
**article no:** 94458/70  
**page:** 472



**name:** Bobbi  
**article no:** 94459/70  
**page:** 472



**name:** Lauren  
**article no:** 94480/70  
**page:** 472

## Industrial Concept Overview



**name:** Lauren  
**article no:** 94481/70  
**page:** 472



**name:** Typhoon  
**article no:** 94492/70  
**page:** 473



**name:** Typhoon  
**article no:** 94491/70  
**page:** 473



**name:** Carmen  
**article no:** 94927/70  
**page:** 528



**name:** Carmen  
**article no:** 94928/70  
**page:** 528



**Mit WOOD**  
Natürlichkeit leben.

**LÄDT EIN DURCH:**

- ▶ warmes Material für ein schönes und gemütliches Zuhause
- ▶ schickes Holzdesign für ein natürliches Gesamtbild
- ▶ kreative Designs für ausgefallene Einrichtungen



**Experience nature**  
with WOOD.

**APPEALING AND INVITING WITH:**

- ▶ Warm material for a beautiful and comfortable home
- ▶ Stylish wooden design for a natural overall image
- ▶ Creative designs for unique places



**Vivez la nature à l'état**  
pur avec WOOD

**VOUS INVITE AVEC:**

- ▶ ses matériaux chaleureux, pour un intérieur charmant et douillet
- ▶ un design bois élégant qui crée un ensemble naturel
- ▶ un style créatif pour un aménagement original



**Vivere la naturalezza,**  
con WOOD.

**INVITANTE GRAZIE A:**

- ▶ materiale caldo per una casa bella e accogliente
- ▶ elegante design in legno per un'immagine complessiva naturale
- ▶ design creativi per arredamenti particolari

# Wood Concept Overview



**name:** Tribe  
**article no:** G33735/88  
**page:** 118



**name:** Tribe  
**article no:** G33730/88  
**page:** 118



**name:** Tribe  
**article no:** G33729/88  
**page:** 118



**name:** Tribe  
**article no:** G33710/88  
**page:** 118



**name:** Forest  
**article no:** 23131/35  
**page:** 120



**name:** Forest  
**article no:** 23130/35  
**page:** 120



**name:** Forest  
**article no:** 23129/35  
**page:** 120



**name:** Forest  
**article no:** 23110/35  
**page:** 120



**name:** Fort  
**article no:** 23431/50  
**page:** 121



**name:** Fort  
**article no:** 23430/50  
**page:** 121



**name:** Fort  
**article no:** 23429/50  
**page:** 121



**name:** Fort  
**article no:** 23410/50  
**page:** 121



**name:** Tree  
**article no:** 33331/35  
**page:** 122



**name:** Tree  
**article no:** 33330/35  
**page:** 122



**name:** Tree  
**article no:** 33329/35  
**page:** 122



**name:** Tree  
**article no:** 33310/35  
**page:** 122



**name:** Tree  
**article no:** 33331/50  
**page:** 123



**name:** Tree  
**article no:** 33330/50  
**page:** 123



**name:** Tree  
**article no:** 33329/50  
**page:** 123



**name:** Tree  
**article no:** 33310/50  
**page:** 123

# Wood Concept Overview



**name:** Polygon  
**article no:** 31970/35  
**page:** 252



**name:** Polygon  
**article no:** 31970/63  
**page:** 252



**name:** Polygon  
**article no:** 31958/35  
**page:** 253



**name:** Polygon  
**article no:** 31949/35  
**page:** 253



**name:** Sansibar  
**article no:** 93646/75  
**page:** 254



**name:** Sansibar  
**article no:** 93647/75  
**page:** 254



**name:** Sansibar  
**article no:** 93648/75  
**page:** 254



**name:** Wooddesign  
**article no:** 93659/35  
**page:** 342



**name:** Wooddesign  
**article no:** 93660/35  
**page:** 342



**name:** Sherwood  
**article no:** 93649/00  
**page:** 343



**name:** Nature  
**article no:** 23073/35  
**page:** 344



**name:** Nature  
**article no:** 23070/35  
**page:** 344



**name:** Nature  
**article no:** 23074/35  
**page:** 344



**name:** Nature  
**article no:** 23073/50  
**page:** 345



**name:** Nature  
**article no:** 23070/50  
**page:** 345



**name:** Nature  
**article no:** 23074/50  
**page:** 345



**name:** Bio  
**article no:** 93610/35  
**page:** 346



**name:** Bio  
**article no:** 93610/50  
**page:** 346



**name:** Homely  
**article no:** 93562/70  
**page:** 347



**name:** North  
**article no:** 93561/70  
**page:** 348

# Wood Concept Overview



**name:** North  
**article no:** 93561/75  
**page:** 348



**name:** Coppa  
**article no:** 93546/05  
**page:** 349



**name:** Hardwood  
**article no:** G94477/35  
**page:** 422



**name:** Hardwood  
**article no:** G94478/35  
**page:** 422



**name:** Hardwood  
**article no:** G94479/35  
**page:** 422



**name:** Widow  
**article no:** 94916/05  
**page:** 506



**name:** Widow  
**article no:** HK12496570  
**page:** 506



**name:** Brandon  
**article no:** 94917/05  
**page:** 507



**name:** Carlyn  
**article no:** 09958A75  
**page:** 508



**name:** Elias  
**article no:** 94919/76  
**page:** 508



**name:** Elias  
**article no:** 94918/74  
**page:** 530



**name:** Elias  
**article no:** 94918/75  
**page:** 530



**name:** Elias  
**article no:** 94918/76  
**page:** 530



**name:** Yorkshire  
**article no:** 94922/35  
**page:** 532



**name:** Yorkshire  
**article no:** 94921/35  
**page:** 532



**name:** Umbrella  
**article no:** 94948/63  
**page:** 534



**name:** Plant  
**article no:** 94924/63  
**page:** 535



**name:** Plant  
**article no:** 94923/35  
**page:** 535



## EASYDIM

EINFACHES DIMMEN MIT IHREM HERKÖMMLICHEN LICHTSCHALTER



## EASYDIM

EASY DIMMING WITH YOUR OWN COMMON LIGHT SWITCH



### SO FUNKTIONIERT'S

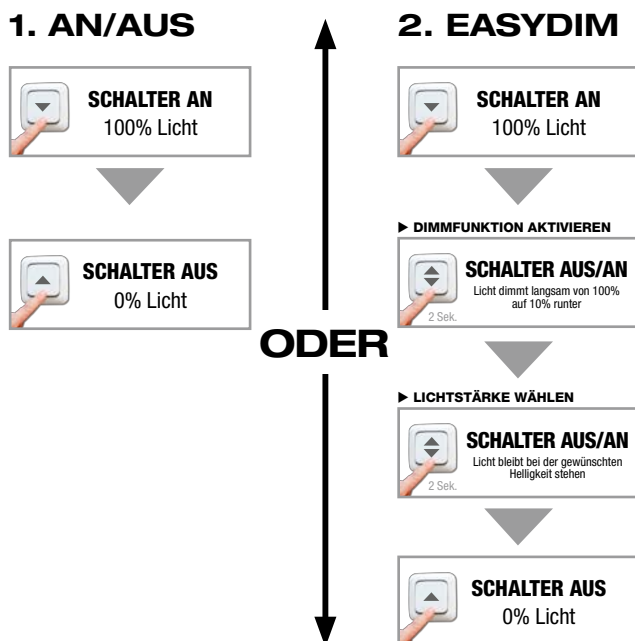

### THIS IS HOW IT WORKS

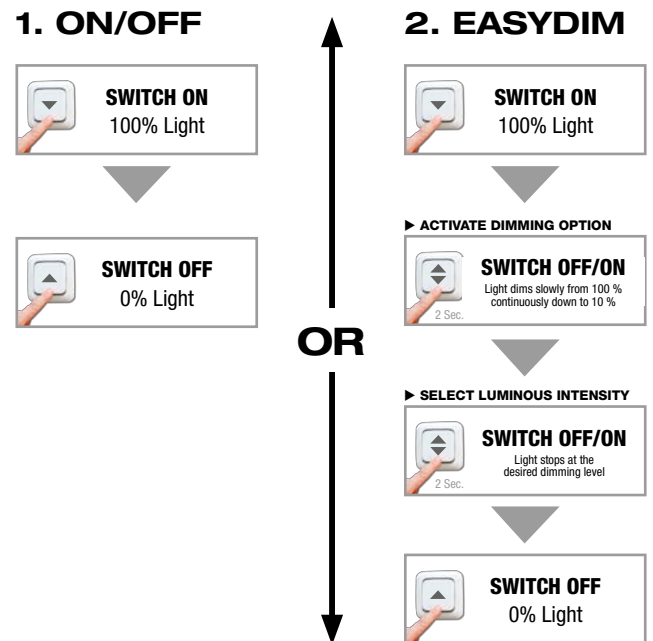

## EASYDIM

RÈGLEZ L'INTENSITÉ LUMINEUSE AVEC VOTRE INTERRUPTEUR.



## EASYDIM

FACILE REGOLAZIONE DELLA LUCE CON IL VOSTRO INTERRUTTORE TRADIZIONALE



### COMMENT ÇA MARCHE

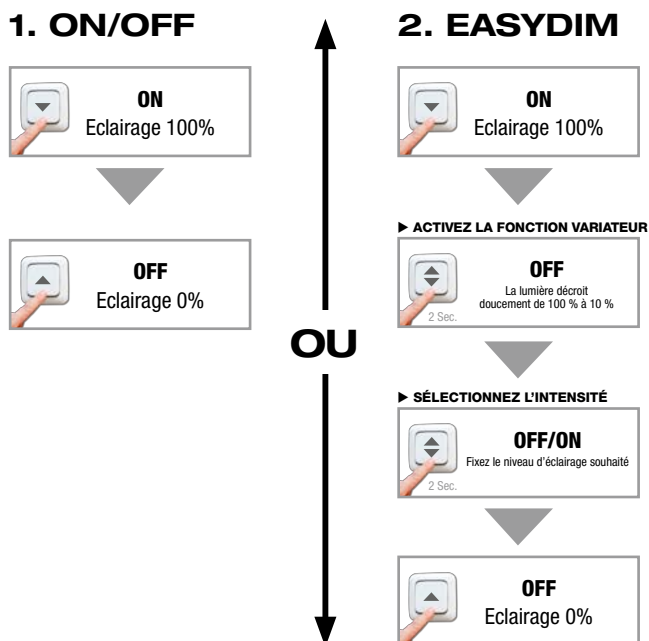

### FUNZIONA COSÌ

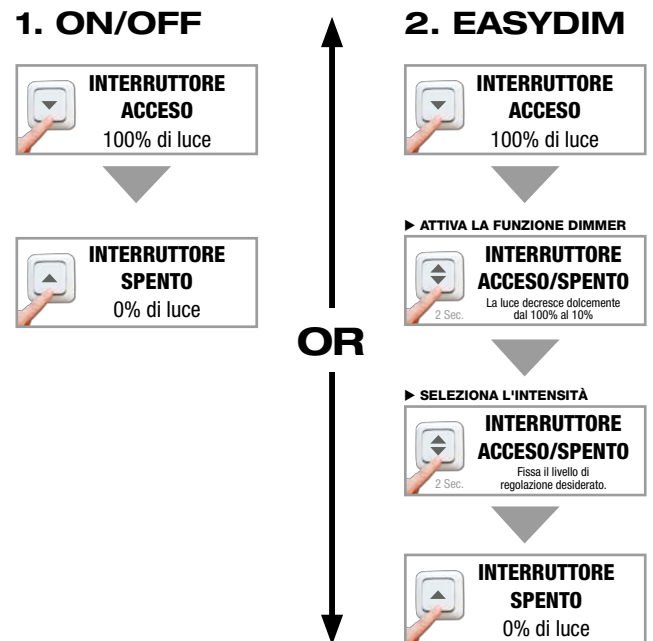

## Easydim Concept Overview



**name:** E14 Candle  
**article no:** 96697/05  
**page:** 10



**name:** E14 Miniglobe  
**article no:** 96698/05  
**page:** 10



**name:** E27 Ambience  
**article no:** 96699/05  
**page:** 10



**name:** E27 Globe  
**article no:** 96700/05  
**page:** 11



**name:** GU10 Reflector  
**article no:** 96701/05  
**page:** 11



**name:** E14 Reflector  
**article no:** 96702/05  
**page:** 11



**name:** Pluto  
**article no:** G30535/13  
**page:** 14



**name:** Pluto  
**article no:** G30532/13  
**page:** 14



**name:** Pluto  
**article no:** G30506/13  
**page:** 14



**name:** Pluto  
**article no:** G30532/15  
**page:** 15



**name:** Pluto  
**article no:** G30506/15  
**page:** 15



**name:** Uranus  
**article no:** G33835/13  
**page:** 16



**name:** Uranus  
**article no:** G33804/13  
**page:** 17



**name:** Uranus  
**article no:** G33832/13  
**page:** 17



**name:** Uranus  
**article no:** G33806/13  
**page:** 17



**name:** Uranus  
**article no:** G33832/15  
**page:** 18



**name:** Uranus  
**article no:** G33806/15  
**page:** 18



**name:** Pluto  
**article no:** G30586/13  
**page:** 360



**name:** Pluto  
**article no:** G30596/13  
**page:** 360



**name:** Uranus  
**article no:** G33896/13  
**page:** 360

## Easydim Concept Overview



**name:** Magellan  
**article no:** G29094/15  
**page:** 362



**name:** Neptun  
**article no:** G94487/15  
**page:** 363



**name:** Neptun  
**article no:** G94486/15  
**page:** 363



**name:** Neptun  
**article no:** G94485/15  
**page:** 363



**name:** Ceres  
**article no:** G94461/13  
**page:** 364



**name:** Ceres  
**article no:** G94461/05  
**page:** 364



**name:** Ceres  
**article no:** G94498/13  
**page:** 365



**name:** Ceres  
**article no:** G94498/05  
**page:** 365



**name:** Ceres  
**article no:** G94463/05  
**page:** 366



**name:** Ceres  
**article no:** G94463/13  
**page:** 366



**name:** Ceres  
**article no:** G94493/13  
**page:** 367



**name:** Ceres  
**article no:** G94493/05  
**page:** 367



**name:** Ceres  
**article no:** G94464/13  
**page:** 367



**name:** Ceres  
**article no:** G94464/05  
**page:** 367



**name:** Honor  
**article no:** G94689A13  
**page:** 594







# TECHNICAL DETAILS

Erklärungen · Guidance · Verklaringen · Explications · Explicación  
Explicações · Vysvetlivky · Objasńenia · Spiegazioni

<b>NAME</b>	<b>Finn</b>	<b>SAFETY CLASS</b>
<b>COLOUR</b>	• satin nickel/white	<b>WIDTH</b>
<b>MATERIAL</b>	• metal/glass	<b>DIAMETER</b>
<b>ART.-NR.</b>	<b>1. G93035/13</b>	<b>BULB INCL.</b> <input checked="" type="checkbox"/>
<b>1. G93035 / 13</b>	± 1800mm    ↔ 610mm →               ø 325mm LED integr., 1 x 18W <input checked="" type="checkbox"/> 1 x 1600 lm, 3000 K, <b>A+</b> LED integr., 1 x 4,5W <input checked="" type="checkbox"/> 1 x 380 lm, 3000 K, <b>A+</b> ↗ LB00000051, 98046/06	<b>LUMEN, KELVIN, EEC CLASS</b>
<b>HEIGHT</b>		<b>SPARE PARTS</b>
<b>THROUT DEPTH</b>		
	 4 004353 200199	

## CE

Alle unsere Leuchten werden nach den Richtlinien der EN 60598 gefertigt. · All our light fittings are manufactured in compliance with the guidelines of EN 60598. · Alle onze lampen worden volgens de richtlijnen EN 60598 vervaardigd. · Toutes nos lampes sont fabriquées en conformité avec les directives EN 60598. · Todas nuestras lámparas se fabrican según la norma EN 60598. · Todas as lâmpadas são produzidas de acordo com a norma EN 60598. · Všetchna svítidla jsou vyráběna podle směrnic evropské normy EN 60598. · Wszystkie lampy produkowane są zgodnie z wytycznymi normy EN 60598. O tutte le nostre lampade sono costruite secondo le direttive EN 60598.

## IP 21

Tropfwassergeschützt · protection against drops of condensed water · druijswaterdicht · protection contre l'eau · protegido contra la condensación de agua · protecção contra humidade e gotas de água · odolné proti vodě · ochrona przed kroplami wody · protezione contro la condensa d'acqua

## IP 44

Spritzwassergeschützt · splashproof · spatwaterdicht · protection contre les projections d'eau · protegida contra salpicaduras de água · protegido contra pingos de água · chráněné proti ostrůku vodou · ochrona przed strumieniem wody · protetto contro l'acqua a spruzzo

## IP 65

Staubdicht und strahlwassergeschützt · dust-tight and protected against water jets · stofdicht en straalwaterdicht · étanche à la poussière et protégé contre les jets d'eau · a prueba de polvo y chorros de agua · à prova de pó e jatos de água · prachotě sně a chráněné proti proudě m vody · ochrona przed pyłem i strumieniem wody · protetto contro la polvere e contro gli spruzzi d'acqua



Schutzklasse I: Diese Leuchte hat einen Schutzleiteranschluss · Protection class I: This lamp has an earth terminal · Beschermlasse I: Deze lamp heeft een veiligheidsaarddraadaansluiting · Catégorie de protection I: Cette lampe possède une prise de terre · Clase de protección I: Este foco dispone de un conector para el cable de protección · Classe de protecção I: Este candeeiro tem em fio de segurança · Trída ochrany I: Toto svítidlo je vybaveno zapojením s ochranným vodičem · Klasa ochronna I: Lampa ta posiada uziemienie · Classe di protezione I: Questa lampada è dotata di morsetto per il collegamento alla messa a terra di protezione.



Schutzklasse II: Diese Leuchte ist doppelt isoliert und darf nicht an einen Schutzleiter angeschlossen werden · Protection class II: This lamp is doubly insulated and must not be connected to an earth wire · Beschermlasse II: Deze lamp is dubbel geïsoleerd en mag niet op een veiligheidsaarddraad worden aangesloten · Catégorie de protection II: Cette lampe est doublement isolée et ne doit pas être branchée sur la terre ·

Clase de protección II: Este foco tiene doble aislamiento y no se debe conectar a un cable de protección · Classe de protecção II: Este candeeiro tem uma isolação dupla e não pode ser ligado ao contacto de segurança · Trída ochrany II: Toto svítidlo je dvojnásobně izolováno a nesmí být připojeno na ochranný vodič; Klasa Ochronna II: Lampa ta posiada podwójną izolację i nie może być podłączona do uziemienia · Classe di protezione II: Questa lampada è dotata di doppio isolamento e non deve essere collegata alla messa a terra di protezione



















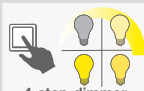

Schutzklasse III: Diese Leuchte darf nur an Schutzkleinspannung bis max. 42 Volt angeschlossen werden · Protection class III: Lamps may only be connected to a safety extra-low voltage with a maximum of 42 V · Beschermlasse III: Lamp mag alleen op veiligheidskleinspanning tot max. 42 volt aangesloten worden · Catégorie de protection III: Cet éclairage doit seulement être raccordé à basses tensions de protection allant jusqu'à 42 Volts · Clase de protección III: La lámpara sólo se puede conectar a una tensión de protección de hasta 42 voltos como máximo · Classe de protecção III: O projector spenas deverá ser conectado a corrente eléctrica de baixa tensão de no máx. 42 Volts · Trída ochrany III: Svítidlo se smí napojovat pouze na ochranné malé napětí do max. 42 V · Klasa Ochronna III: Lampę wolno podłączać jedynie do sieci o niskim napięciu max. 42 Volt · Classe di protezione III: Questa lampada deve essere collegata solo a bassissima tensione di sicurezza.

















## Erklärungen · Guidance · Verklaringen · Explications · Explicación · Explicações · Vysvetlivky · Objasńnienia · Spiegazioni

 <p>LED incl. · LED incl. · LED inclusief · LED inclus · LED incluido · LED incluíd · LED vrátane · w tym LED · LED inclusi</p>	 <p>Farbwechsel · Colour changing · Kleurvariatie · Changement de couleur · Cambio de color · mudança de cor · změna barvy · zmiana koloru · cangiante</p>	 <p>Lichtfarbe einstellbar · Adjustable light colour · Lichtkleur instelbaar · Couleur de lumière réglable · Color de la luz ajustable · Cor da luz ajustável · Nastavitelná barva světlá · regulowany kolor światła · Colore della luce regolabile</p>	 <p>inkl. easydim Technik · Including easydim technology · Incl. easydim-technik · Technique easydim incluse · Incl. Tecnología easydim · incl. tecnologia easydim · vč. techniky easydim · technika easydim · Incl. tecnologia easydim</p>
 <p>dimmbar mit einem dimmbaren Leuchtmittel · Dimmable (with a dimmable lamp) · Dimbaar (met een dimbare verlichting) · Gradable (avec luminaire gradable) · Atenuable (con luminaria atenuable) · intensidade luminosa regulável (com uma lâmpada com intensidade luminosa regulável) · ztlumitelné (se ztlumitelným svetelným zdrojom) · ściemnianie (z urządzeniem ściemniającym światło) · Regolabile (con un corpo luminoso regolabile)</p>	 <p>dimmbar · dimmable · dimbare · dimmable · regulable · regulável · Stmievateľné · ściemniania · dimmerabile</p>	 <p>Fernbedienung · remote control · Afstandsbediening · télécommande · Mando a distancia · control remoto · dálkové ovládání · pilot · telecomando</p>	 <p>Eine Fernbedienung für bis zu 4 Leuchten · One remote control for up to four lamps · Eén afstandsbediening voor maximaal vier lampen · Une télécommande pour jusqu'à 4 luminaires · Control remoto para hasta cuatro luces · um telecomando para até quatro lâmpadas · dálkový ovladač až pro čtyři světla · pilot do obsluhy až czterech lamp · Un comando remoto per un massimo di 4 luci</p>
 <p>App Steuerung · App control · App-besturing · Commande par application · Control por App · Comando da aplicação · Řízení pomocí aplikace · sterowanie APP · Comando App</p>	 <p>Lichtauslass oben und unten · Light outlet at the top and at the bottom · Lichtuitlaat boven- en onderaan · Sortie de lumière en haut et en bas · Emisión de luz superior e inferior · Saída de luz em cima e em baixo · Výstup světla nahore a dole · wylot światła z góry i z dołu · Illuminazione sopra e sotto</p>	 <p>4-Stufen-Dimmer · 4-step dimmer · 4-trapsdimmer · Variateur 4 niveaux · Atenuador de 4 fases · Regulador de intensidade luminosa de 4 níveis · 4 stupňový ztlumovač · 4 stopnie przyciemniania · Dimmer a 4 livelli</p>	 <p>4-Wege-Schalter · 4-way switch · 4-wegsschakelaar · Interrupteurs 4 voies · 4 tipos de conexión · interruptor de 4 vias · 4cestný spínač · 4-pozycyjny przełącznik</p>
 <p>Touchschalter · touch switch · touchschakelaar · interrupteur tactile · interruptor táctil · interruptor táctil · dotykowy spínač · przełącznik dotykowy · interruttore a sfioramento</p>	 <p>Dimmer · dimmer · dimmer · variateur · atenuador de luz · regulador de intensidad · de · stmívač · ściemniacz · dimmer</p>		
 <p>Mit Schalter · with switch · met schakelaar · avec interrupteur · con interruptor · com interruptor · se spínačem · z wyłącznikiem · interruttore</p>	 <p>Schnurzwischenschalter · lead switch · snoerschakelaar · interrupteur sur cordon · interruptor intermedio de cordón · interruptor intercalar preto · šnúrový mezilehly vypínač · wyłącznik pośredni na kablu · interruttore sulla corda</p>	 <p>Zugschalter · pull switch · trekschakelaar · interrupteur à tirette · interruptor de tirador · interruptor accionado por fío · tahacim spínačem · wyłącznik pociągany · cavo con interruttore</p>	

## Erklärungen · Guidance · Verklaringen · Explications · Explicación · Explicações · Vysvetlivky · Objasňenia · Spiegazioni

 <p><b>Sensor</b></p> <p>mit Infrarot-Bewegungsmelder · with infra-red motion detector · met IR-bewegingsmelder · avec détecteur de mouvements à IR · con detector de movimiento por infrarrojos · com detector de movimento a infravermelhos · s infracrveným hlasicem pohybu · ze zintegrowanym czujnikiem na podczerwien · con rivelatore di movimento a raggi infrarossi</p>	 <p>Flexgelenk · flex joint · flexibel · articulation flex · articulación flexible · articulação flexível · ohebný kloub · przgub flex · giunto flex</p> <p>Drehbar · revolving · draaibaar · orientable · giratorio · girável · otočné · obrotowe · girevole</p>	 <p>Höhenverstellbar · Suspension adjustable · Regelbaar in hoogte · réglable en hauteur · altura regulable · Suspensão ajustável · výškově nastavitelné · Lampa wisząca regulowana · altezza regolabile</p>	
 <p><b>MULTI VARIABEL</b></p> <p>vielseitig verstellbar · Multi-variable · Veelzijdig verstelbaar · Multiples réglages possibles · Ampliamente ajustable · Ajustável de forma versátil · Mnohostranné nastaviteľné · peľna regulacja · Molteplici disposizioni</p>	 <p><b>incl.</b></p> <p>Kabel inkl. · cable incl. · kabel inclusief · câble inclus · cable incluido · cabo incluso · kábel vrátane · w tym przewód · cavo incluso</p>	 <p><b>7MM</b></p> <p>7mm · Very flat LED module · Zeer platte ledmodules · Modules LED très plat · Módulo LED extraplano · Módulos LED muito planos · Velmi ploché LED moduly · bardzo płaskie moduly LED · Moduli LED estremamente sottili</p>	 <p><b>QUALITY HANDMADE</b></p> <p>handgefertigtes Glas · Handmade glass · Handgemaakt glas · Verre fabriqué à la main · Vidrio hecho a mano · Vidro fabricado manualmente · Ručně vyrobené sklo · szkło wytwarzane ręcznie · Vetro realizzato a mano</p>
 <p><b>MADE IN EUROPE</b></p> <p>hergestellt in Europa · Made in Europa · Gefabriceerd in Europa · Fabriqué en Europe · Fabricado en Europa · Fabricado na Europa · Vyrobeno v Evropě · wyprodukowano w Europie · Prodotto in Europa</p>	 <p><b>incl.</b></p> <p>Mit elektronischem Transformator · with electronic transformer · met elektronische transformator · avec transformateur électronique · con transformador electrónico · com transformador electrónico · s elektron. transformátorem · z elektron. transformátorem · con trasformatore elettronico</p>	 <p><b>incl.</b></p> <p>Fußschalter · foot switch · voetschakelaar · interrupteur à pied · interruptor de pie · interruptor de pé · nožní spínač · wyłącznik nożny · interruttore a pedale</p>	 <p><b>incl.</b></p> <p>Steckdose enthalten · powerpoint included · Contactdoos inbegrepen · prise incluse · incluye enchufe · tomada incluida · obsahuje zásuvku · zawiera gniazdo wtykowe · presa inclusa</p>
 <p><b>5 year WARRANTY</b></p> <p>5 Jahre Garantie · 5-year warranty · 5 jaar garantie · Garantie 5 ans · 5 años de garantía · 5 anos de garantia · 5 let záruka · 5 lat gwarancji · 5 anni di garanzia</p>			







# TERMS / INDEX



## Section 1 General Scope / Offers

1. Our sales and delivery terms shall be exclusively applicable; terms to the contrary or terms deviating from those of the purchaser will not be recognized by us, unless we have expressly agreed to their validity in writing. Our sales and delivery terms shall also be applicable if aware of terms to the contrary or terms deviating from purchaser's terms we will without any proviso carry out the delivery to the purchaser. An assignment ban in the Buyer's conditions is expressly refuted.
2. Any agreements entered into between us and the purchaser with the intention of implementing the contract, will have to be defined in writing.
3. Our purchasing and delivery terms shall also be applicable to all future transactions with the purchaser.
4. Our offers are net and free. Contracts will be entered into upon receipt of our written order confirmation, latest when the goods have been delivered. We can accept orders within four weeks.

## Section II Prices, Freight Charges/ Payment Terms

1. Prices are net plus German value added tax (V.A.T.) and freight charges ex works or ex warehouse, unless anything else has been expressly specified in writing.

For orders exceeding a net goods value of Euro 750.-, Brilliant will not charge any freight expenses. In case of a net goods value of Euro 750.- or less, Brilliant will charge a global freight rate of 7% of the goods net value for domestic deliveries, however at least Euro 12.50.

2. Payment of the purchase price shall take place within the agreed term, within ten days after receipt of invoice net, unless agreed differently.
3. Bills (promissory notes), and checks will be accepted by us only upon prior agreement and provided they can be taken on discount. All discount fees shall be debited to the customer and have to remunerated to us at once. Bill or check amounts will be credited only upon definite receipt of the equivalent amount.
4. If payments are overdue, we shall be entitled to charge 8% interest for delay above the respective to as set out in § 247 of the German Civil Code. If we are able to claim a higher delay damage, we shall be entitled to assert it. Purchasers on the other hand shall be entitled to provide evidence that due to such payment delays we have either not been suffering any damage or to a much lesser extent.
5. If the purchaser will not pay its money when due or if a serious deterioration in its financial position has been incurred, we shall be entitled to make payable the entire remaining amount due, even though we already have accepted bills or checks from the purchaser. In such particular circumstances we shall be entitled to ask for prepayments or securities and to refuse fulfillment of our obligations until we have received such prepayments or securities.

If such requests will not have been fulfilled within the suitable period specified by us, we shall be justified to withdraw from the contract and/or to claim damages because of non-performance. In case of cessation of payments or over-indebtedness, an additional period of time will not be granted.

6. We shall be entitled to set off all purchaser's outstanding accounts payable to us against our outstanding accounts payable to purchaser. The purchaser's setting off rights will be acceptable only if its counterclaims have been asserted to be legal, undisputed, and approved by us. For any disputed counterclaims, purchaser shall be not able to assert any right of retention.
7. In the case of a delay with more than one liability, the complete claim against the Buyer is immediately due for payment.
8. Our claims have been relinquished in favour of the Deutsche Factoring Bank, Bremen.

## Section III. Reservation of Proprietary Rights

1. All produce supplied shall remain our sole property until all outstanding accounts payable to us which we are entitled to against the purchaser for any legal reason have been paid.

If for exceptional reasons the purchaser receives from us an acceptor's bill, this reservation of proprietary rights shall secure our claims under our right of recourse against the purchaser in case of any recourse based on the bill.

2. Processing, converting and incorporating with other products shall be carried out for us as the manufacturer, yet without any risk on our part. If due to incorporation, our (co) ownership shall cease, it shall be agreed even now, that the (co) ownership in the new product shall devolve to us on the pro rata basis of its invoice value of our product to the other products at the time of processing. Purchaser shall hold our (co) property in trust for us free of charge. Any products in which we have a co-ownership, shall be termed 'reserved goods'.

3. Purchaser shall be entitled to process and sell the reserved goods in the ordinary course of business, in as much as the purchaser discharges its business relationship obligations towards us in due time. Any authorization to transfer the sale to any third parties shall be excluded if between the purchaser of the reserved goods and its clients a covenant against assignment is in existence. The purchaser shall not be entitled to pawn the reserved goods, nor pledge them as collateral security. Purchaser shall assign to us even now by way of collateral security any outstanding accounts and rights in the sale goods or in any other respect, (e.g. insurance, illicit act regarding the reserved goods).

If we have only a co-ownership in any reserved product, the anticipatory assignment shall be limited to the part of the claim in keeping with the participation of our co-ownership (based on the invoice amounts).

4. Purchaser shall be authorized revocably by us to collect any outstanding accounts on its own account and in its own name. This collecting authority can be revoked if the purchaser does not discharge its contractual payment obligations towards us in due time. In case of a justified revocation, the purchaser shall be obliged to name any debtor/s of the assigned outstanding accounts and inform such debtor/s of the assignment.

This will apply particularly if any third party shall assert any warranty claim in opposition to the purchaser's accrued outstanding accounts.

Price reductions due to defects and set-offs due to compensation for damage have to be set off against any part of the outstanding accounts not assigned to us. In as much as the purchaser has agreed to a preferred partial assignment in favour of other trade creditor, this section shall apply with the purpose, that the purchaser may collect the partial outstanding accounts ceded to us jointly with the preferred partial outstanding accounts.

5. Purchaser shall be obliged to inform us without delay of any third party's execution enforced on the reserved goods and shall instruct such third party about their being our property.
6. If purchaser is in default - such as delay of payments - we shall be entitled to request a temporary surrender of the reserved goods without granting a grace period, and at purchaser's expense - in handing over or dispatching the goods to us - or possibly requesting assignment of purchaser's rights of recovery towards any third party.

Such surrender or seizure of the preferred goods to and by us does not imply contract withdrawal. This section shall also apply if a serious deterioration of the purchasers' assets becomes evident.

7. Upon purchaser's request we agree at our own discretion to release the above collateral securities, in as much as the amount exceeds the value of our claim to be secured by more than 10%.
8. Purchaser shall also cede to us its claims to secure our claims against purchaser, which due to the connection of the purchased matter with a piece of real estate will be raised against any third party.
9. We shall be entitled to insure the reserved goods against all risks of any kind at purchaser's expense, unless upon being requested by us, the purchaser submits evidence of a respective insurance policy. Any part amount owing to us claimed and paid out of this insurance shall be ceded to us in advance when entering into any respective contract. We shall be entitled to inform the insurance company of such cession.

## Section IV Delivery and Lead Time

1. Unless any deviating specification is to be found in the order confirmation, delivery shall be "ex works" e.g. "ex warehouse". The risk of loss or damage of the goods shall pass to the purchaser as soon as the goods have been handed over to the haulage contractor, latest when they are removed from our warehouse. This holds also true if "carriage or freight paid" has been agreed, and in case of partial deliveries or if any additional services of some other kind have been performed out by us.

2. Insurance of the goods against any transport risks shall take place only upon purchaser's express request and at purchaser's costs.

3. Delivery quoted by us shall commence only when all technical details have been clarified and will not be binding, unless a commercial transaction at a fixed

date has been expressly agreed. Lead times shall commence upon receipt of our order confirmation. Date of delivery shall mean receipt of the goods in the home country.

4. To an extent reasonable for the purchaser, we shall be free to carry out partial deliveries.

5. We shall be entitled to delay or cancel delivery expected from us or to reduce the amount delivered if we are prevented from or hindered in or delayed through any circumstances beyond our control as for instance strikes, lock-outs, transport obstacles, shortage or out of stock of raw materials, measures taken by public authorities – also experienced by our suppliers – during any period such as force majeure, conditions will subsist. Damages – as far as legally permissible – may not be claimed under these conditions.

6. If purchaser suffers any damage due to any delay caused by us, purchaser shall be entitled to compensation. Such entitlement shall be justified if we have not observed a given a period of grace granted by the purchaser to remedy any defects. The compensation amount shall be a maximum of 1% per week, but not more than 5% in total, of the delayed part of the overall shipment which has not been available in time. Any further claims shall be excluded, unless the delay is due to at least gross negligence.

If purchaser delays acceptance of the goods or culpably fails to cooperate, we shall be entitled to request purchaser to remunerate any damage suffered by us including any possible additional costs. In this case the risk of loss or damage of the purchased goods will devolve to the purchaser, as soon as purchaser is in delay of acceptance of the goods.

7. Should the customer require a Proof of Delivery (POD) on the ordered goods, they will be required to pay a handling fee, provided that the goods were delivered to the consignee in accordance with the given instructions. A POD can only be requested by the customer within the usual retention period for the corresponding documentation of the haulier or carrier engaged. After this period the delivery requirements will be deemed to have been met.

## Section V Warranties and Limitation of Liabilities

1. Warranties are based on the proviso of tests and requirements to give notice of defects pursuant to § 377 of the German Commercial Code which have been carried out and complied with.

2. If any defect in the purchased product becomes evident, we shall be entitled either to remedy the defect or to replace the defective product delivered.

3. If we are not prepared or not able to remedy the defect /replace the defective product, or if due to any deficiency on our part such remedy is delayed beyond a suitable time, or if such remedy/replacement will miscarry for some reason or other, the purchaser shall have the option to withdraw from contract or to claim a respective reduction of the purchase price.

A reimbursement of expenses is excluded, insofar as the expenditure arises, due to the goods being brought to a different place following our delivery, unless this is required for the agreed use of the goods.

4. Unless in the following sections nothing to the contrary will be defined, any further purchaser's claims shall be excluded - irrespective of any legal reasons whatsoever. For any damage not incurred on the delivered product itself, we shall not be liable. Neither shall we be liable for any losses suffered in purchaser's profits or property.

5. The limitation of claims for material defects, should nothing else be agreed, is guided by the law.

6. The customer's legal right to make a claim for compensation against us arises only when the customer has not reached an agreement with his purchaser that goes beyond his statutory rights. Clause 3 of the last sentence is additionally valid concerning the extent of the claims for compensation.

7. The above release from liability shall not apply if the cause of damage is due to intentional or gross negligence (except if the damage was incurred due to the gross negligence of a person employed in performing an obligation or by any vicarious agent, or the damage is based on the violation of a major contractual obligation). Furthermore, the obligation to render compensation / liability to pay damages shall be limited to the damage likely to be expected.

8. Any delivery is according to current law - and those legal provisions which will be effective at a later date - of the European Union and The Federal Republic of Germany, e.g. REACH-regulation (regulation EG no. 1907/2006) and the law of return and ecological disposal of electrical equipment (ElektroG) as national implementation of the directive 2002/95/EG (RoHS) and the directive

2002/96/EG (WEEE).

## Section VI Joint and Several Liability

1. The limitation or exclusion of liabilities for compensation of damage referred to in section V shall apply in like manner to all claims due to default in contract conclusion, violation of subsidiary duties, in particular to claims arising out of producer's liability as set out in § 823 of the German Civil Code.

2. The regulation specified in section VI. 1 shall not apply to claims according to §§ 1.4 of the product liability law. Neither shall it apply to cases of initial incapacity or evident impossibility.

3. In as much as our liability is excluded, such an exclusion also applies to the personal liability of our staff, employees, agents and vicarious agents.

4. Any deviation in technology or construction of descriptions or specifications in sales literature, catalogues, and written documentation as well as any changes in prototypes, constructions, and materials, made in the course of technical progress, shall be reserved, without any interpretation of rights being permissible against us, in as much as this will still be acceptable to the purchaser.

## Section VII Usage Rights for Images

Any kind of exploitation or other use of photographs or other copyrighted contents which Brilliant AG on a website it maintains or publicly reproduces or makes available in any other way is prohibited. However, use can be permitted by Brilliant AG in a separate agreement.

## Section VIII Data protection

The data of the Customer shall be stored and processed by us in compliance with the statutory provisions.

## Section IX Return of goods

1. The return of defect-free goods requires our prior written agreement, otherwise we are entitled to refuse to accept the goods.

2. If we have expressly agreed to the return of the goods in accordance with clause 1. above or we accept returned defect-free goods, we are entitled to invoice the Customer with processing costs to the amount of 30 % of the net sales price. Furthermore, the Customer shall pay all transport costs as well as the costs for packaging, surrounding packaging and any repair.

## Section X Place of Performance, Legal Venue, and Applicable Law

1. Place of performance for our deliveries ex works shall be such selfsame works, if delivered ex warehouse, it shall be such selfsame warehouse. Place of performance for payments shall be Gnarrenburg.

2. Place of jurisdiction for all payment matters and any other disputes arising directly or indirectly from this contractual relationship is Hamburg. We reserve the right however to take legal action against the purchaser at his general place of jurisdiction. Hamburg shall be the exclusive legal venue for any across border deliveries for all litigations arising from the contract relationship.

(Art. 17, EU-GVÜ).

We reserve the right to invoke any other competent EU-GVÜ court.

3. For all business relationships and all legal relationships between the purchaser and us, solely the law of the Federal Republic of Germany shall apply. The uniform law concerning the international purchase of movable objects (EKG), as well as the United Nations Convention regarding international contracts on the purchase of goods (CISG) shall not apply.

Brilliant Aktiengesellschaft (PLC)  
Issued August 2016



## I. Allgemeines / Geltungsbereich / Angebot

1. Unsere Verkaufs- und Lieferbedingungen gelten ausschließlich; entgegenstehende oder von unseren Verkaufs- und Lieferbedingungen abweichende Bedingungen des Käufers erkennen wir nicht an, es sei denn, wir hätten ausdrücklich schriftlich ihrer Geltung zugestimmt.

Unsere Verkaufs- und Lieferbedingungen gelten auch dann, wenn wir in Kenntnis entgegenstehender oder von unseren Verkaufsbedingungen abweichender Bedingungen des Käufers die Lieferung an den Käufer vorbehaltlos ausführen. Einem Abtretungsverbot in Bedingungen des Käufers wird ausdrücklich widersprochen.

2. Alle Vereinbarungen, die zwischen uns und dem Käufer zwecks Ausführung des Vertrages getroffen werden, sind schriftlich niederzulegen.

3. Unsere Verkaufs- und Lieferbedingungen gelten auch für alle künftigen Geschäfte mit dem Käufer.

4. Unsere Angebote sind freibleibend und unverbindlich. Auf Bestellungen hin kommen alle Verträge erst mit Zugang unserer schriftlichen Auftragsbestätigung, spätestens mit Übergabe der Ware, zustande. Bestellungen können wir innerhalb von vier Wochen annehmen.

## II. Preise / Fracht / Zahlungsbedingungen

1. Die Preise verstehen sich netto zuzüglich Mehrwertsteuer und Fracht ab Werk oder Lager; es sei denn, es ist ausdrücklich und schriftlich etwas anderes vereinbart. Bei Aufträgen über einem Warennettowert von Euro 750,- verzichtet Brilliant AG auf die Geltendmachung der Fracht. Bei einem Warennettowert von Euro 750,- oder weniger berechnet Brilliant AG im Inland pauschal eine Frachtrate von 7% des Warennettwertes, mindestens jedoch Euro 12,50.

2. Die Zahlung des Kaufpreises hat innerhalb der vereinbarten Frist, mangels anderer Vereinbarungen innerhalb von 10 Tagen ab Rechnungsdatum netto zu erfolgen.

3. Wechsel und Schecks nehmen wir nur nach vorheriger Vereinbarung und unter Vorbehalt ihrer Diskontierbarkeit entgegen. Sämtliche Diskontspesen gehen zu Lasten des Kunden und sind uns sofort zu vergüten. Eine Gutschrift der Wechsel- und Scheckbeträge erfolgt erst dann, wenn uns der Gegenwert endgültig zur Verfügung steht.

4. Bei Überschreitungen des Zahlungsziels sind wir berechtigt, Verzugszinsen in Höhe von 8% über dem jeweiligen Basiszinssatz gem. § 247 BGB zu fordern. Falls wir in der Lage sind, einen höheren Verzugschaden nachzuweisen, sind wir berechtigt, diesen geltend zu machen. Der Käufer ist seinerseits berechtigt, uns nachzuweisen, dass uns als Folge des Zahlungsverzugs kein oder ein wesentlich geringerer Schaden entstanden ist.

5. Kommt der Käufer bis Fälligkeit seinen Zahlungsverpflichtungen nicht nach oder liegt eine wesentliche Vermögensverschlechterung bei ihm vor, so sind wir berechtigt, die gesamte Restschuld fällig zu stellen, auch wenn wir bereits Wechsel oder Schecks angenommen haben.

Wir sind in dem Fall außerdem berechtigt, Vorauszahlungen oder Sicherheitsleistungen zu verlangen und die Erfüllung unserer Verpflichtung bis zur Vorauszahlung oder Sicherheitsleistung zu verweigern. Wird unser Verlangen binnen einer von uns gesetzten angemessenen Frist nicht erfüllt, so sind wir berechtigt, vom Vertrag zurückzutreten und/oder Schadensersatz wegen Nichterfüllung zu verlangen. Bei Zahlungseinstellung oder Überschuldung des Käufers entfällt die Setzung einer Nachfrist.

6. Aufrechnungsrechte stehen dem Käufer nur zu, wenn seine Gegenansprüche rechtskräftig festgestellt, unbestritten oder von uns anerkannt sind.

Wegen bestrittener Gegenansprüche steht dem Käufer auch kein Zurückbehaltungsrecht zu.

7. Im Falle des Verzuges mit mehr als einer Verbindlichkeit sind die gesamten Forderungen gegen den Käufer sofort zur Zahlung fällig.

8. Unsere Forderungen sind an die Deutsche Factoring Bank, Bremen, abgetreten.

## III. Eigentumsvorbehalt

1. Sämtliche gelieferte Sachen bleiben bis zur Erfüllung aller Forderungen, die uns aus jedem Rechtsgrund gegen den Käufer jeweils zustehen, unser alleiniges Eigentum. Wird dem Käufer bei Zahlung ausnahmsweise von uns ein „umgedrehter Wechsel“ (Akzeptanten-Wechsel) gegeben, so sichert der

Eigentumsvorbehalt auch unsere Rückgriffsansprüche gegen den Käufer bei einer eventuellen Inanspruchnahme aus dem Wechsel.

2. Verarbeitung, Umbildung und Vermischung erfolgen stets für uns als Hersteller, jedoch ohne Verpflichtung für uns. Erlischt unser (Mit-)Eigentum durch Verbindung oder Vermischung, so wird bereits jetzt vereinbart, dass das (Mit-)Eigentum an der neuen Sache im Verhältnis des Rechnungswertes unserer Sache zu denen anderer verarbeitender Waren zur Zeit der Verarbeitung auf uns übergeht. Der Käufer verwahrt unser (Mit-) Eigentum unentgeltlich. Sachen, an denen uns (Mit-) Eigentum zusteht, werden im folgenden als „Vorbehaltsware“ bezeichnet.

3. Der Käufer ist berechtigt, die Vorbehaltsware im ordnungsgemäßen Geschäftsverkehr zu verarbeiten und zu veräußern, solange er mit seinen Zahlungsverpflichtungen uns gegenüber nicht im Verzug ist.

Die Ermächtigung zur weiteren Veräußerung wird ausgeschlossen für den Fall, dass im Verhältnis zwischen dem Vorbehaltskäufer und seinem Kunden ein Abtretungsverbot besteht. Verpfändungen oder Sicherungsübereignungen sind unzulässig. Die aus dem Weiterverkauf oder einem sonstigen Rechtsgrund (z. B. Versicherung, unerlaubter Handlung bezüglich der Vorbehaltsware) entstandenen Forderungen tritt der Käufer bereits jetzt sicherungshalber an uns ab. Steht uns nur Miteigentum an einer Vorbehaltsware zu, so beschränkt sich die Vorausabtretung auf den Teil der Forderung, der dem Anteil unseres Miteigentums (auf der Basis des Rechnungswertes) entspricht.

4. Wir ermächtigen den Käufer widerruflich, die an uns abgetretenen Forderungen für eigene Rechnungen im eigenen Namen einzuziehen. Diese Einziehungsermächtigung kann widerrufen werden, wenn der Käufer seinen Zahlungsverpflichtungen nicht ordnungsgemäß nachkommt.

Für den Fall eines berechtigten Widerrufs hat uns der Käufer den/die Schuldner der abgetretenen Forderung mitzuteilen und dem/den Schuldner(n) die Abtretung unverzüglich anzuzeigen. Der an uns abgetretene Forderungsteil hat den Vorrang. Dies gilt insbesondere für den Fall, dass der Dritte der dem Käufer erwachsene Forderung Gewährleistungsansprüche entgegenhält.

Minderungen und Aufrechnungen mit Schadensersatzansprüchen sind zuerst auf den uns nicht abgetretenen Forderungsanteil zu verrechnen. Soweit der Käufer eine bevorrechtigte Teilabtretung auch zugunsten anderer Warenkreditgeber vereinbart hat, gilt diese Ziffer mit der Maßgabe, dass der Käufer die uns abgetretene Teilforderung zugleich mit jenen bevorrechtigten Teilforderungen einziehen darf.

5. Bei Zugriffen Dritter auf Vorbehaltsware wird der Käufer auf unser Eigentum hinweisen und uns unverzüglich benachrichtigen.

6. Bei vertragswidrigem Verhalten des Käufers - insbesondere Zahlungsverzug - sind wir berechtigt, die Vorbehaltsware auch ohne Nachfristsetzung auf Kosten des Käufers einstweilen herauszuverlangen - durch Herausgabe oder Rücksendung an uns - oder ggf. Abtretung der Herausgabeansprüche des Käufers gegen Dritte zu fordern.

In der Zurücknahme sowie in der Pfändung der Vorbehaltsware durch uns liegt - soweit nicht das Verbraucherkreditgesetz Anwendung findet - kein Rücktritt vom Vertrag. Die vorstehende Regelung findet auch Anwendung im Falle einer wesentlichen Vermögensverschlechterung beim Käufer.

7. Die vorgenannten Sicherheiten geben wir auf Verlangen des Käufers nach unserer Wahl frei, soweit ihr Wert unsere Forderung um mehr als 10% übersteigt.

8. Der Käufer tritt uns auch die Forderungen zur Sicherung unserer Forderungen gegen ihn ab, die durch die Verbindung der Kaufsache mit einem Grundstück gegen einen Dritten erwachsen.

9. Wir sind berechtigt, die Vorbehaltsware gegen Gefahren aller Art auf Kosten des Käufers zu versichern, sofern er nicht nach einer entsprechenden Anforderung durch uns den Abschluss einer derartigen Versicherung nachweist. Ansprüche aus dieser Versicherung werden in Höhe der uns zustehenden Forderungen mit Abschluss des jeweiligen Vertrages im voraus an uns abgetreten. Wir sind berechtigt, die Abtretung dem Versicherer anzuzeigen.

## IV. Lieferung und Lieferzeit

1. Sofern sich aus der Auftragsbestätigung nichts anderes ergibt, ist Lieferung „ab Werk“ bzw. „ab Lager“ vereinbart. Die Gefahr des Untergangs oder der Beschädigung der Ware geht in dem Zeitpunkt auf den Käufer über, in welchem wir die Ware an einen Spediteur oder Frachtführer übergeben, spätestens jedoch mit Verlassen unseres Lagers. Dies gilt auch dann, wenn „frachtfrei“ vereinbart worden ist sowie bei Teillieferung oder wenn von uns noch Leistungen anderer Art übernommen worden sind.

2. Eine Versicherung der Ware gegen Transportschäden erfolgt nur auf ausdrücklichen Wunsch und Kosten des Käufers.

3. Der Beginn der von uns angegebenen Lieferzeit setzt die Klärung aller technischen Fragen voraus und ist unverbindlich, sofern nicht ausdrücklich ein kaufmännisches Fixgeschäft vereinbart wurde. Lieferfristen beginnen mit dem Zugang unserer Auftragsbestätigung. Der Liefertermin bezeichnet den Eingang beim Kunden im Inland.

4. Zu Teilleistungen sind wir in für den Käufer zumutbarem Umfang berechtigt.

5. Wird die von uns geschuldete Lieferung durch unvorhersehbare und von uns unverschuldete Umstände verzögert (z. B. Arbeitskämpfe, Betriebsstörungen, Transporthindernisse, Rohmaterialmangel, behördliche Maßnahmen - jeweils auch bei unseren Vorlieferanten - sowie nicht rechtzeitige Selbstbelieferung), so sind wir berechtigt, ganz oder teilweise vom Vertrag zurückzutreten oder nach unserer Wahl die Belieferung um die Dauer der Behinderung hinauszuschieben. Schadensersatzansprüche sind - soweit rechtlich zulässig - ausgeschlossen.

6. Sollte dem Käufer aufgrund eines von uns verschuldeten Verzuges ein Schaden erwachsen, so ist er berechtigt, eine Verzugsentschädigung zu fordern. Das Recht zur Geltendmachung setzt voraus, dass wir eine vom Käufer schriftlich gesetzte angemessene Nachfrist nicht eingehalten haben. Die Höhe der Verzugsentschädigung beträgt für jede volle Woche des Verzuges maximal 1%, insgesamt aber höchstens 5% vom Wert desjenigen Teils der Gesamtlieferung, der infolge der Verspätung nicht rechtzeitig zur Verfügung steht. Darüber hinausgehende Ansprüche sind ausgeschlossen, es sei denn, der Verzug beruht auf zumindest grober Fahrlässigkeit. Kommt der Käufer in Annahmeverzug oder unterlässt er schuldhaft die Mitwirkungspflichten, so sind wir berechtigt, von ihm zu verlangen, den uns entstandenen Schaden einschließlich etwaiger Mehraufwendungen zu ersetzen. In dem Fall geht auch die Gefahr eines zufälligen Untergangs oder einer zufälligen Verschlechterung der Kaufsache in dem Zeitpunkt auf den Käufer über, in dem dieser in Annahmeverzug gerät.

7. Verlangt der Käufer einen Liefernachweis für bestellte Ware, hat er die Nachforschungsgebühren zu tragen, sofern die Ware ordnungsgemäß beim Empfänger abgeliefert wurde. Diesen Nachweis kann der Käufer nur innerhalb der üblichen Aufbewahrungsfrist der entsprechenden Dokumente beim beauftragten Spediteur oder Frachtführer verlangen. Nach Ablauf dieser Frist gilt die Lieferungsleistung als erbracht.

## V. Gewährleistungen und Haftungsbeschränkungen

1. Gewährleistungsansprüche setzen voraus, dass die Untersuchungs- und Rügeobliegenheiten der § 377 HGB beachtet wurden.

2. Soweit ein von uns zu vertretener Mangel der Kaufsache vorliegt, sind wir nach unserer Wahl zur Mängelbeseitigung oder Ersatzlieferung berechtigt.

3. Sind wir zur Mängelbeseitigung/Ersatzlieferung nicht bereit oder in der Lage, insbesondere verzögert sich diese über angemessene Fristen hinaus aus Gründen, die wir zu vertreten haben, oder schlägt in sonstiger Weise die Mängelbeseitigung/Ersatzlieferung fehl, so ist der Käufer nach seiner Wahl berechtigt, vom Vertrag zurückzutreten oder eine entsprechende Minderung des Kaufpreises zu verlangen. Eine Kostenerstattung ist ausgeschlossen, soweit die Aufwendungen sich erhöhen, weil die Ware nach unserer Lieferung an einen anderen Ort verbracht worden ist, es sei denn, dies entspricht dem bestimmungsmäßigen Gebrauch der Ware.

4. Soweit sich nachstehend nichts anderes ergibt, sind weitergehende Ansprüche des Käufers - gleich, aus welchen Rechtsgründen - ausgeschlossen. Wir haften deshalb nicht für Schäden, die nicht am Liefergegenstand selbst entstanden sind. Insbesondere haften wir nicht für entgangenen Gewinn oder sonstige Vermögensschäden des Käufers.

5. Die Verjährung der Sachmängelansprüche richtet sich, soweit nichts anderes vereinbart ist, nach dem Gesetz.

6. Gesetzliche Rückgriffsansprüche des Käufers gegen uns bestehen nur insoweit, als der Käufer mit seinem Abnehmer keine Vereinbarungen getroffen hat, die über die gesetzlichen Mängelansprüche hinausgehen. Für den Umfang der Rückgriffsansprüche gilt ferner Ziff. 3 letzter Satz entsprechend.

7. Vorstehende Haftungsfreizeichnung gilt nicht, soweit die Schadensursache auf Vorsatz oder grober Fahrlässigkeit beruht (ausgenommen, wenn der Schaden durch grobe Fahrlässigkeit eines Erfüllungs- oder Verrichtungsgehilfen verursacht wurde, es sei denn, der Schaden beruht auf Verletzung einer vertraglichen Hauptpflicht). Im Übrigen ist die Ersatzpflicht auf den vorhersehbaren Schaden begrenzt.

8. Bei unseren Lieferungen halten wir die bei Vertragsschluss und später geltenden gesetzlichen Regelungen der Europäischen Union und der Bundesrepublik

Deutschland ein, z.B. die REACH-Verordnung (Verordnung EG Nr. 1907/2006) und das Gesetz über die Rücknahme und umweltverträgliche Entsorgung von Elektro- und Elektronikgeräten (ElektroG) als nationale Umsetzung der Richtlinie 2002/95/EG (RoHS) und der Richtlinie 2002/96/EG (WEEE).

## VI. Gesamthaftung

1. Soweit gemäß Ziff. V. unsere Haftung auf Schadenersatz ausgeschlossen oder beschränkt ist, gilt dies auch für alle Ansprüche wegen Verschuldens bei Vertragsschluss, Verletzung von Nebenpflichten, insbesondere für Ansprüche aus Produzentenhaftung gemäß § 823 BGB.

2. Die Regelung gemäß Ziff. VI. 1. gilt nicht für Ansprüche gemäß den §§ 1, 4 Produkthaftungsgesetz. Gleiches gilt bei anfänglichem Unvermögen oder zu vertretender Unmöglichkeit.

3. Soweit unsere Haftung ausgeschlossen oder beschränkt ist, gilt dies auch für die persönliche Haftung unserer Angestellten, Arbeitnehmer, Mitarbeiter, Vertreter und Erfüllungsgehilfen.

4. Technische und gestalterische Abweichung von Beschreibungen und Angaben in Prospekten, Katalogen und schriftlichen Unterlagen sowie Modell-, Konstruktions- und Materialänderung im Zuge des technischen Fortschritts bleiben vorbehalten, ohne dass hieraus Rechte gegen uns hergeleitet werden können, soweit dies für den Käufer noch zumutbar ist.

## VII. Bildnutzungsrechte

Jede Art der Verwertung oder sonstiger Nutzung von Fotografien oder sonstigem urheberrechtlich geschützten Inhalten, welche die Brilliant AG auf einer von ihr unterhaltenen Internetseite verwendet oder in sonstiger Weise öffentlich wiedergibt oder bereit hält, ist untersagt. Die Nutzung kann jedoch in einer besonderen Vereinbarung durch die Brilliant AG gestattet werden.

## VIII. Datenschutz

Die Daten des Käufers werden unter Beachtung der gesetzlichen Vorschriften von uns gespeichert und verarbeitet.

## IX. Warenrücknahme

1. Die Rücksendung mangelfreier Ware setzt unser vorheriges schriftliches Einverständnis voraus. Anderenfalls sind wir berechtigt, die Annahme der Ware zu verweigern.

2. Haben wir uns mit der Rücksendung der Ware gemäß vorstehender Ziffer 1. einverstanden erklärt oder nehmen wir zurückgesandte mangelfreie Ware an, sind wir berechtigt, dem Käufer Bearbeitungskosten in Höhe von 30 % des Netto-Verkaufspreises zu berechnen. Ferner hat der Käufer sämtliche Transportkosten sowie Kosten der Verpackung, Umverpackung und eventuellen Instandsetzung zu tragen.

## X. Erfüllungsort, Gerichtsstand und anzuwendendes Recht

1. Erfüllung für unsere Lieferung ist bei Lieferung ab Werk das Lieferwerk, bei Lieferung ab Lager das Lager. Erfüllungsort für Zahlungen ist Gnarrenburg.

2. Gerichtsstand in Zahlungsangelegenheiten und in allen anderen sich aus diesem Vertragsverhältnis unmittelbar oder mittelbar ergebenden Streitigkeiten ist Hamburg. Wir haben jedoch das Recht, den Käufer an seinem allgemeinen Gerichtsstand zu verklagen. Auch bei grenzüberschreitender Lieferung ist ausschließlich Gerichtsstand für alle Streitigkeiten aus dem Vertragsverhältnis Hamburg (Art. 17 EU-GVÜ). Wir behalten uns das Recht vor, auch jedes andere Gericht anzurufen, das aufgrund des EU-GVÜ zuständig ist.

3. Für alle Geschäftsbeziehungen und die gesamten Rechtsbeziehungen zwischen dem Kunden und uns gilt ausschließlich das Recht der Bundesrepublik Deutschland. Die Anwendung des einheitlichen Gesetzes über den internationalen Kauf beweglicher Sachen (EKG) sowie des Übereinkommens der Vereinten Nationen über Verträge über den internationalen Warenkauf (CISG) ist ausgeschlossen.

Brilliant AG  
Stand 08/16

Name / Art. Nr.	Page	Name / Art. Nr.	Page	Name / Art. Nr.	Page	Name / Art. Nr.	Page
<b>A</b>		<b>ATHENA</b>	94427/29 462	<b>BIRDS</b>	92603/80 613	<b>BULB</b>	21213/15 78
ADRANO	90215/13 442	<b>AZTEKAS</b>	24991/75 215	<b>BIRDS</b>	56099P72 613	<b>BULB</b>	21216/15 78
ADRIANA	G92970/15 518	<b>AZTEKAS</b>	24991/85 215	<b>BIRDS</b>	G56034/72 612	<b>BULB</b>	21258/15 192
AGLAE	94873/05 542	<b>AZTEKAS</b>	24970/75 215	<b>BIRDS</b>	56070/72 613	<b>BULBY</b>	17347/15 193
AGLAE	94873/22 542	<b>AZTEKAS</b>	24970/85 215	<b>BIRDS</b>	G56048/72 612	<b>BULBY</b>	17370/15 193
AGLAE	94873/63 542	<b>AZTEKAS</b>	24910/75 106	<b>BIRDS</b>	G56047/72 612	<b>BUMBLE</b>	93232/09 316
ALHAMBRA	92958/75 554	<b>AZTEKAS</b>	24910/85 107	<b>BISTRO</b>	11170/11 353	<b>C</b>	
ALHAMBRA	92958/00 554	<b>AZTEKAS</b>	24913/85 107	<b>BLOCK</b>	G94455/15 384	<b>CARLINO</b>	G94818/13 490
ALICA	G94156/15 402	<b>AZTEKAS</b>	24913/75 106	<b>BLOCK</b>	G94456/15 384	<b>CARLYN</b>	09958A75 508
ALMIRA	93388/05 350	<b>AZTEKAS</b>	24932/85 107	<b>BLOCK</b>	G94457/15 384	<b>CARMEN</b>	94927/70 528
ALMIRA	93388/06 350	<b>AZTEKAS</b>	24932/75 106	<b>BOBBI</b>	94458/70 472	<b>CARMEN</b>	94928/70 528
AMALFI LED	G21510/13 63	<b>B</b>		<b>BOBBI</b>	94459/70 472	<b>CAT</b>	05910/75 469
AMALFI LED	G21513/13 63	<b>BABETT</b>	G94254/05 373	<b>BOMBAY</b>	G92928/13 558	<b>CAT</b>	05998/75 469
AMALFI LED	G21532/13 63	<b>BABETT</b>	G94255/05 373	<b>BOMBILLA</b>	93609/15 296	<b>CATHLEEN</b>	G94163/15 406
AMALFI LED	G21534/13 63	<b>BANKIR</b>	92679/31 580	<b>BOMBILLA</b>	93619/15 296	<b>CELEST</b>	G21906/15 29
AMIRA	77347/20 238	<b>BASIC</b>	G94318/05 414	<b>BONA</b>	10548/05 225	<b>CELEST</b>	G21910/15 29
AMIRA	77371/20 238	<b>BEACH</b>	G94453/15 148	<b>BONA</b>	10570/05 225	<b>CELEST</b>	G21913/15 29
AMIRA	77379/20 238	<b>BEACH</b>	G94454/15 148	<b>BONA</b>	10599/05 225	<b>CELEST</b>	G21932/15 29
ANAI	93983/70 457	<b>BEAUTY</b>	G26110/77 22	<b>BONA</b>	10578/05 225	<b>CERES</b>	G94460/13 364
ANCOLIE	93674/21 324	<b>BEAUTY</b>	G26113/77 22	<b>BONA</b>	10510/05 84	<b>CERES</b>	G94460/05 364
ANCOLIE	93674/29 324	<b>BEAUTY</b>	G26133/77 22	<b>BONA</b>	10513/05 84	<b>CERES</b>	G94461/13 364
ANDALUZ	90010/13 442	<b>BEAUTY</b>	G26131/77 22	<b>BONA</b>	10532/05 84	<b>CERES</b>	G94461/05 364
ANDALUZ	90011/13 442	<b>BECCA</b>	92961/05 513	<b>BONA</b>	10534/05 84	<b>CERES</b>	G94462/05 366
ANDRIA	93522/20 438	<b>BELIZ</b>	94056/70 456	<b>BONNIE</b>	G94209/93 74	<b>CERES</b>	G94462/13 366
ANDRIA	93522/05 439	<b>BELIZ</b>	94057/70 456	<b>BORGO</b>	92931/73 586	<b>CERES</b>	G94463/05 366
ANDRIA	93522/63 440	<b>BENKO</b>	G26210/77 39	<b>BORGO</b>	92931/74 586	<b>CERES</b>	G94463/13 366
ANDRIA	93580/20 438	<b>BENKO</b>	G26229/77 39	<b>BORGO</b>	92931/78 586	<b>CERES</b>	G94464/05 367
ANDRIA	93581/20 438	<b>BENKO</b>	G26230/77 39	<b>BOSTON</b>	12848/13 223	<b>CERES</b>	G94464/13 367
ANDRIA	93580/05 439	<b>BENTE</b>	93617/70 335	<b>BOSTON</b>	12858/13 223	<b>CERES</b>	G94493/05 367
ANDRIA	93581/05 439	<b>BENTE</b>	G26310/70 116	<b>BOSTON</b>	12870/13 222	<b>CERES</b>	G94493/13 367
ANOUC	93444/70 334	<b>BENTE</b>	G26324/70 116	<b>BOSTON</b>	12876/13 222	<b>CERES</b>	G94498/05 365
ANOUC	F-93444/70 334	<b>BENTE</b>	G26334/70 116	<b>BOSTON</b>	12871/13 222	<b>CERES</b>	G94498/13 365
ANTHONY	G92935/03 570	<b>BENTLI</b>	26810/76 117	<b>BRADLEY</b>	G94810/75 561	<b>CHARLIE</b>	18110/15 92
ANTHONY	G92935/04 570	<b>BENTLI</b>	26824/76 117	<b>BRANDON</b>	94917/05 507	<b>CHARLIE</b>	18113/15 92
ANTHONY	G92935/05 570	<b>BENTLI</b>	26834/76 117	<b>BRENDAN</b>	G94808/11 560	<b>CHARLIE</b>	18193/15 92
ANTHONY	G92935/11 570	<b>BERNADETTE</b>	G93451/75 272	<b>BRILLIANCE</b>	93620/29 171	<b>CHARLIE</b>	18196/15 92
ANTHONY	G92935/17 570	<b>BETHANY</b>	G55210/77 47	<b>BRILLIANCE</b>	93620/15 169	<b>CHRIS</b>	56478/05 355
ANTHONY	G92936/05 571	<b>BETHANY</b>	G55213/77 47	<b>BRILLIANCE</b>	93621/29 170	<b>CINDA LED</b>	G10910/75 70
ANTHONY	G92936/11 571	<b>BETHANY</b>	G55234/77 47	<b>BRILLIANCE</b>	93621/15 168	<b>CINDA LED</b>	G10929/75 70
AREZZO	28551/58 463	<b>BETHANY</b>	G55232/77 47	<b>BRILLIANCE</b>	93623/15 168	<b>CINDA LED</b>	G10934/75 70
ARIANA	73578/13 352	<b>BETSY</b>	G93547/13 283	<b>BRILLIANCE</b>	93623/29 170	<b>CINE</b>	HK13018S70 501
ARLENA	G93434/15 274	<b>BETTER</b>	G17570/13 278	<b>BRILLIANCE</b>	93622/15 169	<b>CINTA</b>	G22610/15 76
ARLENA	G93435/15 274	<b>BETTER</b>	G17572/13 278	<b>BRILLIANCE</b>	93622/29 171	<b>CINTA</b>	G22613/15 76
ART WORK	G65156/21 162	<b>BETTER</b>	G17573/13 278	<b>BRITNEY</b>	94271/22 466	<b>CINTA</b>	G22693/15 196
ART WORK	G65142/21 162	<b>BILLY</b>	94447/76 240	<b>BUDAPEST</b>	G94248/70 416	<b>CINTA</b>	G22694/15 196
ART WORK	G65172/21 162	<b>BILLY</b>	93677/76 240	<b>BUDAPEST</b>	G94249/70 416	<b>CINTA</b>	G22695/15 196
ARTHUR	G93032/77 482	<b>BIO</b>	93610/35 346	<b>BULB</b>	93429/15 192	<b>CINTA</b>	G22642/15 197
ASTA 30	G02893/82 606	<b>BIO</b>	93610/50 346	<b>BULB</b>	21210/15 78	<b>CINTA</b>	G22659/15 197

Name / Art. Nr.	Page	Name / Art. Nr.	Page	Name / Art. Nr.	Page	Name / Art. Nr.	Page
CINTA	G22692/15 197	CROSSING	G08573/21 286	DIRT	93613/74 339	ELANA	G94214/70 430
CINTA	22670/15 197	CROSSING	G08599/21 411	DJERBA	90100/05 453	ELEGANCE	G93528/15 263
CINTA	G22632/15 76	CRUSH	94466/15 214	DJERBA	90101/05 453	ELEGANT	G93525/15 262
CIRCLE	G94440/15 149	CRUSH	94466/85 214	DJERBA	90102/05 453	ELEGANT	G93526/15 262
CIRCLE	G94465/15 149	CRUSH	94467/15 214	DNA	G94468/13 158	ELEGANT	G93527/15 263
CITY	93994/00 435	CRUSH	94467/85 214	DNA	G94469/13 158	ELENA	66747/76 239
CLAP	G94909/15 565	CURVED	G93504/13 281	DNA	G94470/13 159	ELENA	66773/76 239
CLARIE	93374/05 232	<b>D</b>		DNA	G94471/13 159	ELENA	66792/76 239
CLARIE	93374/06 234	DAISY	G92968/05 522	DONUT	G04090/15 144	ELIAS	94918/74 530
CLARIE	93374/22 233	DAISY	G92968/04 522	DONUT	G04091/15 147	ELIAS	94918/75 530
CLARIE	13258/05 232	DAISY	G92968/78 522	DONUT	G04095/15 147	ELIAS	94918/76 530
CLARIE	13258/22 233	DAJANA	G94343/77 390	DONUT	G04070/15 146	ELIAS	94919/76 508
CLARIE	13291/05 232	DALMA	93478/29 243	DONUT	G04076/15 146	ELYSEE	90266/82 444
CLARIE	13291/22 233	DALMA	21010/76 112	DONUT	G04073/15 144	ELYSEE	90267/82 444
CLARIE	13247/05 232	DALMA	21013/76 112	DOORS RO.	G19191/15 374	ENZIO	66472/43 320
CLARIE	13247/06 234	DALMA	21034/76 112	DOORS RO.	G19192/15 374	EODE	38994/15 194
CLARIE	13247/22 233	DALMA	21048/76 242	DOORS RO.	G19193/15 374	EODE	38998/15 194
CLARIE	13291/06 234	DALMA	21074/76 242	DOORS RO.	G19194/15 374	EODE	38992/15 194
CLASSIC LED	G94674/05 605	DALMA	21094/76 113	DOORS RO.	G19195/15 374	EODE	38942/15 195
CLASSIC LED	G94674/13 605	DALMA	21096/76 113	DOORS SQ.	G16291/13 375	EODE	38959/15 195
CLASSIC LED	G94675/05 604	DALMA	21059/76 242	DOORS SQ.	G16292/13 375	EQUINOX	G94308/05 425
CLASSIC LED	G94675/13 604	DARCEY	94671/05 609	DOORS SQ.	G16293/13 375	ERIK	70170/13 353
CLASSIC LED	G94684/05 605	DARCEY	94672/05 609	DOORS SQ.	G16294/13 375	ETERNITY	G94472/15 379
CLASSIC LED	G94684/13 605	DARIUS	53524A05 474	DOORS SQ.	G16295/13 375	EVERGREEN	92752/00 520
CLASSIC LED	G94685/05 604	DARIUS	G53500A05 474	DUBAI	93532/15 188	EVERGREEN	G92752/72 520
CLASSIC LED	G94685/13 604	DARIUS	G53500A75 474	DUBAI	93585/15 188	EVERGREEN	92852/00 520
COMB	G12211/77 38	DARIUS	G53501A05 474	DUBAI	93627/15 189	EVERGREEN	G96284/72 521
COMB	G12213/77 38	DARIUS	G53501A75 474	DUBAI	93628/15 189	<b>F</b>	
COMB	G12234/77 38	DARLINGTON	27160/13 496	DUBLIN	92922/05 539	FAIR	G94473/13 391
COMB	G12232/77 38	DARLINGTON	27161/13 496	DUBLIN	92922/06 539	FAKIR	G94246/05 424
COPPA	93546/05 349	DATE	26995/15 190	DUBLIN	92923/06 511	FAKIR	G94306/05 424
COPPRA	93552/31 328	DATE	26970/15 191	<b>E</b>		FAKIR	G98809/05 424
CORLIOLIS	93595/76 329	DATE	26973/15 190	EARTH	94088/70 456	FALKO	G94307/05 425
COSA 15	G03090/73 606	DATE	26974/15 191	EASY CLIP	G94649/05 596	FANTASIA	93275/05 305
COSA 15	G03090/82 606	DATE	26910/15 191	EASY CLIP	G94649/13 596	FANTASIA	93277/05 305
COSA 15	G03090/75 606	DELTA	G93624/15 264	EASY CLIP	G94650/05 596	FANTASIE	G94438/15 400
COSA 30	G03093/73 607	DELTA	G93625/15 154	EASY CLIP	G94650/13 596	FANTASIE	G94439/15 400
COSA 30	G03093/82 607	DELTA	G93626/15 154	EASY CLIP	G94651/05 597	FASHION RO.	G16991/13 394
COSA 30	G03093/75 607	DEMIAN	G93033/77 483	EASY CLIP	G94651/13 597	FASHION RO.	G16993/13 394
COSA 45	G03094/75 607	DESERT	93618/02 338	EASY CLIP	G94652/05 597	FASHION RO.	G16995/13 394
COSMOS	07510T05 138	DESERT	93618/03 338	EASY CLIP	G94652/13 597	FASHION SQ.	G16891/13 395
COSMOS	07529T05 138	DESERT	93618/72 338	EASYDIM BULB	96697/05 10	FASHION SQ.	G16893/13 395
COSMOS	07534T05 138	DIFFERENT	94416/05 105	EASYDIM BULB	96698/05 10	FASHION SQ.	G16895/13 395
COSMOS	07501T05 138	DIFFERENT	27091/05 105	EASYDIM BULB	96699/05 10	FELIZIA LED	G94676/05 603
CROSSING	G08511/21 41	DIFFERENT	27010/05 104	EASYDIM BULB	96700/05 11	FELIZIA LED	G94676/13 603
CROSSING	G08529/21 41	DIFFERENT	27030/05 104	EASYDIM BULB	96701/05 11	FELIZIA LED	G94677/05 602
CROSSING	G08530/21 41	DIFFERENT	27035/05 104	EASYDIM BULB	96702/05 11	FELIZIA LED	G94677/13 602
CROSSING	G08535/21 41	DIRT	93613/55 339	EIFFEL TOWER	94860/09 536	FELIZIA LED	G94686/05 603

Name / Art. Nr.	Page	Name / Art. Nr.	Page	Name / Art. Nr.	Page	Name / Art. Nr.	Page
FELIZIA LED	G94686/13 603	FORT	23430/50 121	GLITZ	93415/05 313	INA LED	G77710/05 69
FELIZIA LED	G94687/05 602	FORT	23431/50 121	GRACE	93675/13 325	INA LED	G77729/05 69
FELIZIA LED	G94687/13 602	FRAME	G37410/77 60	GRACE	93675/29 325	INA LED	G77732/05 69
FEODORA	93611/29 331	FRAME	G37429/77 60	GRACIAN	93663/18 321	INA LED	G77734/05 69
FIALA	G94216/05 430	FRAME	G37430/77 60	GRAFITTI	94476/63 110	INA LED	G77710/06 68
FIDSCHI	90186/35 461	FRAME	G37431/77 60	GRAFITTI	94475/63 110	INA LED	G77729/06 68
FIDSCHI	90181/35 461	FRANCA	G94673/05 600	GRAFITTI	94474/63 110	INA LED	G77734/06 68
FIDSCHI	90186/36 461	FRANCA	G94673/13 600	GRIGORY	94905/76 527	INA LED	G77732/06 68
FIDSCHI	90181/36 461	FREE	G94338/05 398	GRIGORY	94905/75 541	INAYA	G93575/15 268
FILAMENT BULB	96694A10 326	FREE	G94337/05 398	GRIGORY	94905/86 541	INBAL	HK12707S06 318
FILAMENT BULB	96704A10 326	FREE	G94336/05 398	GRIMSBY	93589/70 332	INBAL	HK12707S05 318
FILMO	94929/15 500	FREYA	93220/05 352	GUDY	G94368/15 413	INDEPENDENT	93563/22 229
FINE	G94390/15 404	FRIEDA	93630/70 340	GUDY	G94369/15 413	INDEPENDENT	93564/22 229
FINE	G94391/15 404	FRIEDA	93668/76 340	<b>H</b>		INDEPENDENT	93635/22 228
FINE	G94389/15 404	FUERTE	92975/03 525	HANDY	92984/06 526	INDEPENDENT	93636/22 228
FINN	G93035/13 484	FUERTE	92975/01 525	HANJO	G93030/15 272	INDEPENDENT	93637/22 228
FIORE	81910/58 236	FUERTE	92975/05 525	HARDWOOD	G94477/35 422	INDY	93250/00 351
FIORE	81949/58 237	FUERTE	92975/08 525	HARDWOOD	G94478/35 422	ISAR	90238/05 454
FIORE	81970/58 236	FURORE	65010/77 82	HARDWOOD	G94479/35 422	ISAR	90239/05 454
FIORE	81971/58 236	FURORE	65013/77 82	HEDA	G36810/77 33	ISAR	90240/05 454
FIRST	93518/75 303	FURORE	65034/77 82	HEDA	G36813/77 33	ISAR	90241/05 454
FIXED	G94330/21 419	<b>G</b>		HEDA	G36832/77 33	ISI	02747/05 549
FIZZY	94421/00 449	GABON	12910/20 127	HENRY	92706/06 579	ISI	02747/71 549
FLAT	G94395/05 371	GABON	12913/20 127	HENRY	92706/15 579	ISI	02747/20 548
FLAT	G94396/05 371	GABON	12934/20 127	HIPPOLYTE	93597/29 330	ISI	02747/22 548
FLAT	G94397/05 371	GALINA	G93671/15 271	HOBBY	10802/01 578	ISI	02747/23 548
FLEETWOOD	93588/70 332	GALINA	G93672/15 271	HOBBY	10802/05 578	ISI	02747/63 548
FLEX	24705T05 588	GARDIS	G93673/77 270	HOBBY	10802/06 578	ISI	02747/78 549
FLEX	24705T06 588	GATE	G93507/15 155	HOBBY	10802/11 578	IZON LED	G94442/21 418
FLEX	24705/37 588	GATE	G93508/15 155	HOLGER	G92941/22 564	IZON LED	G94443/21 418
FLEX	24705/72 588	GENTLE	93509/22 436	HOME	94906/76 527	IZON LED	G94444/21 418
FLEX	24705/11 588	GENTLE	93509/20 436	HOMELY	93562/70 347	<b>J</b>	
FONDA	22510/15 202	GHOST	93584/15 294	HONOR	G94689A13 594	JAAP	G92734/06 558
FONDA	22534/15 202	GIBRALTAR	90078/05 447	HORIZONT	93560/22 322	JAIMIE	G94417/13 391
FONDA	22548/15 203	GIORGIA	G05505/77 45	<b>I</b>		JAN	92762/01 581
FONDA	22559/15 203	GIORGIA	G05511/77 45	ICE GLASS	G93542/15 266	JAN	92762/05 581
FONDA	22574/15 203	GIORGIA	G05529/77 45	ICEDROP	93582/15 218	JAN	92762/06 581
FONDA	22595/15 202	GIORGIA	G05532/77 45	ICEDROP	93583/15 219	JANE	93661/15 300
FOREST	23110/35 120	GIORGIA	G05535/77 45	ICEDROP	93632/15 218	JANE	93662/15 300
FOREST	23129/35 120	GIORGIA	G05573/77 291	ICEDROP	93634/05 218	JANIS	38776/13 301
FOREST	23130/35 120	GIRAFFE	94868/86 231	ICEDROP	93633/05 218	JANNA	G46110/77 46
FOREST	23131/35 120	GIRAFFE	94869/86 231	IKA	70970/70 357	JANNA	G46113/77 46
FORMULAR	G28691/15 427	GIRAFFE	94869/63 230	INA	07770/05 350	JANNA	G46116/77 46
FORMULAR	G28692/15 427	GIRAFFE	94868/63 230	INA	07770/06 350	JANNA	G46132/77 46
FORMULAR	G28693/15 427	GITSE	93669/15 298	INA	07710/77 90	JANNA	G46112/77 46
FORMULAR	G28694/15 427	GITSE	93670/15 298	INA	07713/77 90	JARNO	G94256/05 372
FORT	23410/50 121	GLENN	G94871/05 563	INA	07732/77 90	JARNO	G94257/05 372
FORT	23429/50 121	GLENN	G94871/06 563	INA	07734/77 90	JENNY	92604/04 582



Name / Art. Nr.	Page	Name / Art. Nr.	Page	Name / Art. Nr.	Page	Name / Art. Nr.	Page
JENNY	92604/07 582	KATRINA	G94816/06 568	LEA	G32410/77 44	LUCA	35832/56 129
JENNY	92604/11 582	KATRINA	G94816/11 568	LEA	G32429/77 44	LUCA	35832/77 87
JENNY	92604/78 582	KELLY	G94410/15 432	LEA	G32434/77 44	LUCA	35812/77 87
JENNY	92604/03 582	KENSINGTON	50410/15 80	LEA	G32432/77 44	LUCA	35810/56 129
JERSEY	93034/06 494	KENSINGTON	50416/15 80	LEA	G32473/77 165	LUCA	35810/77 87
JERSEY	93034/05 494	KENSINGTON	50434/15 80	LEA	G32459/77 165	LUCA	35813/56 129
JERSEY	93034/58 494	KIMBER LED	G39210/15 53	LEEDS	34810/15 81	LUCA	35813/77 87
JESPER	23710/70 249	KIMBER LED	G39230/15 53	LEEDS	34829/15 81	LUCIE	93020/71 514
JESPER	23749/70 249	KIMBER LED	G39234/15 53	LEEDS	34831/15 81	LUCIE	93020/73 514
JESPER	23758/70 249	KINLEY	93461/05 464	LEO	G24801A05 574	LUCIE	93020/74 514
JESPER	23770/70 248	KINLEY	93461/20 464	LEO	G24801A06 574	LUCY	G93004/13 488
JESPER	23771/70 248	KLEA	93909/70 457	LEONID	93601/06 330	LUNAO	93600/15 302
JOKER	93553/15 297	KOLJA	G94658/05 593	LIGHT STR. LED	G93931A72 477	<b>M</b>	
JOKER	93554/15 297	KOLJA	G94659/05 593	LIGHT STR. LED	G93932A72 477	MAGELLAN	G29091/15 362
JOLEEN	G92974/31 559	KORA	37910/52 100	LIGHT STR. LED	G93933A72 477	MAGELLAN	G29092/15 362
JOYA	94854/15 198	KORA	37910/71 101	LIGHT STR. MUSIC	G94432A72 476	MAGELLAN	G29093/15 362
JOYA	94855/15 198	KORA	37910/75 98	LILLE	92929/77 557	MAGELLAN	G29094/15 362
JOYA	00299/15 198	KORA	37910/76 99	LIPARI LED	G38811/13 67	MAGIC	18048/79 178
JOYA	00210/15 199	KORA	37924/52 100	LIPARI LED	G38813/13 67	MAGIC	18070/79 181
JOYA	00213/15 199	KORA	37924/71 101	LIPARI LED	G38816/13 67	MAGIC	18073/79 181
JOYA	00233/15 199	KORA	37924/75 98	LIPARI LED	G38832/13 67	MAGIC	18074/79 180
JOYA	00206/15 199	KORA	37924/76 99	LIPPA	94422/05 448	MAGIC	18075/79 180
JOYA	00293/15 198	KORA	37934/52 100	LIPPA	94423/05 448	MAGIC	18093/79 178
JUNIOR	99122/05 587	KORA	37934/71 101	LIQUID	G93539/13 276	MAGIC	18095/79 178
JUNIOR	99122/06 587	KORA	37934/75 98	LIQUID	G93540/13 276	MAGNITO LED	G21610/15 50
JUNIOR	99122/03 587	KORA	37934/76 99	LIVORNO	90288/11 447	MAGNITO LED	G21629/15 50
JUNIOR	99122/11 587	KYRA	90339/13 444	LOGO	78270/04 354	MAGNITO LED	G21631/15 50
JUNO	57610/70 125	<b>L</b>		LOGO	78270/78 354	MAGNITO LED	G21635/15 50
JUNO	57629/70 125	LARINA	G94279/15 401	LOGO	78270/01 354	MAGNOLIA	93851/75 446
JUNO	57634/70 125	LARINA	G94280/15 401	LOGO	78270/73 354	MAGNOLIA	93851/76 446
JUNO	57632/70 125	LARINA	G94281/15 401	LOGO	78270/05 354	MAGNOLIA	93852/75 446
JUPP LED	G18310/76 54	LASTRA	G38110/15 28	LOGO	78270/11 354	MAGNOLIA	93852/76 446
JUPP LED	G18313/76 54	LASTRA	G38113/15 28	LOMÉ	92732/06 547	MAILAND	93514/05 220
JUPP LED	G18334/76 54	LASTRA	G38132/15 28	LOMÉ	92732/75 547	MAILAND	93513/05 220
JUPP LED	G18332/76 54	LASTRA	G38134/15 28	LOONA	G28810/13 64	MAILAND	93512/05 220
<b>K</b>		LAUREEN	G94660/05 592	LOONA	G28813/13 64	MAIRA	G14710/15 201
KAGO	93612/29 331	LAUREEN	G94661/05 592	LOONA	G28832/13 64	MAIRA	G14772/15 200
KARINA	G94895/06 562	LAUREN	94480/70 472	LOONA	G28834/13 64	MAIRA	G14773/15 200
KASHA	94874/03 543	LAUREN	94481/70 472	LOONA	G28842/13 65	MAIRA	G14776/15 200
KASHA	94874/05 543	LAVA	39510/56 124	LOONA	G28810/05 66	MALINDA	G94220/75 414
KASHA	94874/17 543	LAVA	39510/77 94	LOONA	G28813/05 66	MANAGUA	G92960A03 524
KASSANDRA	G34710/77 57	LAVA	39513/56 124	LOONA	G28834/05 66	MANAGUA	G92960A05 524
KASSANDRA	G34729/77 57	LAVA	39513/77 94	LOONA	G28832/05 66	MANAGUA	G92960A17 524
KASSANDRA	G34735/77 57	LAVA	39516/56 124	LOONA	G28833/13 65	MANDAL	93639/15 308
KATALINA	G94258/05 372	LAVA	39516/77 94	LOONA	G28840/13 65	MANDAL	93640/15 308
KATALINA	G94259/05 372	LAVA	39532/56 124	LOOP	G94482/13 392	MARIUS	G94227/75 426
KATRINA	G94816/04 568	LAVA	39532/77 94	LUCA	35816/56 129	MARIUS	G94228/75 426
KATRINA	G94816/05 568	LAWINA	94669/15 608	LUCA	35816/77 87	MARTINO	G94264/15 403

Name / Art. Nr.	Page	Name / Art. Nr.	Page	Name / Art. Nr.	Page	Name / Art. Nr.	Page
MARTINO	G94265/15 403	MINOR	06310T06 136	MUSIC	G94403/13 420	ODINE	94046/05 456
MARTINO	G94266/15 403	MINOR	06329T05 135	<b>N</b>		OLLIE	G93036/13 485
MARTINO	G94267/15 403	MINOR	06329T06 136	NADIA	94010/20 463	OLLIE	G93036/31 485
MARTU	22710/15 247	MINOR	06330T05 135	NARCISSA	G34610/15 32	OPALINA	G07110/77 34
MARTU	22770/15 247	MINOR	06330T06 136	NARCISSA	G34629/15 32	OPALINA	G07116/77 34
MARTU	22790/15 247	MINOR	06334T05 135	NARCISSA	G34635/15 32	OPALINA	G07131/77 34
MAURITIUS	90103/07 460	MINOR	06334T06 136	NARJA	G93455/13 282	OSAKA	71170A07 356
MAURITIUS	90104/07 460	MINOR	06311/05 134	NASH XL	G93418/15 292	OSAKA	71170A03 356
MAURITIUS	90105/07 460	MIRAMAR	90196/05 450	NASH XXL	G93328/15 293	OSAKA	71170A05 356
MAURITIUS	90103/05 452	MIRAMAR	90191/05 450	NATURE	23070/35 344	OSAKA	71170A02 356
MAURITIUS	90103/20 460	MIRAMAR	90191/15 450	NATURE	23070/50 345	OVAL	G94327/13 415
MAURITIUS	90103/03 452	MIRAMAR	90196/15 450	NATURE	23073/35 344	<b>P</b>	
MAURITIUS	90104/05 452	MIRAMAR	90191/13 451	NATURE	23073/50 345	PACOME	G35710/15 42
MAURITIUS	90104/20 460	MIRAMAR	90196/13 451	NATURE	23074/35 344	PACOME	G35713/15 42
MAURITIUS	90104/03 452	MIRAMAR LED	G98813/15 431	NATURE	23074/50 345	PACOME	G35793/15 42
MAURITIUS	90105/05 452	MIRAMAR LED	G98813/13 431	NELE	G94920/05 562	PACOME	G35795/15 42
MAURITIUS	90105/20 460	MIRAMAR LED	G98813/05 431	NELE	G94920/06 562	PALIN	G98808/15 426
MAURITIUS	90105/03 452	MIRELLA	G93454/75 164	NEPTUN	G94485/15 363	PANARO	G93548/13 283
MAYFAIR	93460/76 328	MIRELLA	G39642/75 164	NEPTUN	G94486/15 363	PAOLO	92907/01 545
MEET	G94825/77 498	MIRELLA	G39695/75 164	NEPTUN	G94487/15 363	PAOLO	92907/04 545
MELINA	G92949/15 518	MIRELLA	G39654/75 164	NEREIDE	92645/15 505	PAOLO	92907/20 545
MELVILLE	94429/05 470	MOLLIE	G94164/15 406	NEREIDE	92645/29 505	PASTELL	74270/05 353
MELVILLE	94429/13 470	MONA	93248/77 306	NERVA	92603/75 512	PEARL	67347/75 556
METTLE	92789/76 501	MONA	93249/77 306	NERVA	92603/81 512	PEARL	67347/56 556
MIKA	94272/06 467	MORATO	21412/05 455	NEW DESIGN	G94333/15 381	PERFECT	G17449/13 566
MILANO LED	G21710/76 51	MORATO	21412/06 455	NEW HAVEN	G93452/75 269	PERFECT	G17456/13 499
MILANO LED	G21713/76 51	MORE	G13610/15 36	NEW ORLEANS	G94412/15 410	PERRY	94428/13 471
MILANO LED	G21732/76 51	MORE	G13613/15 36	NEW YORK	G94907/06 538	PHAROS	HK13021S13 319
MILANO LED	G21734/76 51	MORE	G13632/15 36	NEW YORK	G94908/06 510	PHARRELL	G94837/02 584
MILANO LED	G21732/22 73	MORE	G13633/15 36	NIEBLA	94424/15 449	PHARRELL	G94837/04 584
MILANO LED	G21710/75 72	MORRIS	90007B15 443	NIKITA	G94807/06 560	PHARRELL	G94837/07 584
MILANO LED	G21710/22 73	MOUNTAIN	G11429/15 408	NOBLE	94435/15 186	PHARRELL	G94837/17 584
MILANO LED	G21713/75 72	MOUNTAIN	G11430/15 408	NOBLE	94436/15 187	PHILO	G16394/13 48
MILANO LED	G21713/22 73	MOUNTAIN	G11431/15 408	NOBLE	29210/15 186	PHILO	G16348/13 166
MILANO LED	G21734/75 72	MOUNTAIN	G11435/15 408	NOBLE	29230/15 186	PHILO	G16348/18 166
MILANO LED	G21734/22 73	MOUNTAIN	G11410/15 408	NOBLE	29235/15 186	PHILO	G16358/13 166
MILANO LED	G21732/75 72	MOVABLE	G94483/15 21	NORTH	93561/70 348	PHILO	G16358/18 166
MILOS	17810/56 128	MOVABLE	G94484/15 21	NORTH	93561/75 348	PHILO	G16310/13 48
MILOS	17829/56 128	MOVIE	92709/06 526	<b>O</b>		PHILO	G16313/13 48
MILOS	17832/56 128	MOVIE	07810/15 91	OCA	39411/77 86	PHILO	G16332/13 48
MILOS	17834/56 128	MOVIE	07813/15 91	OCA	39429/77 86	PHILO	G16334/13 48
MINOR	06310/11 137	MOVIE	07831/15 91	OCA	39434/77 86	PHILO	G16372/13 167
MINOR	06329/11 137	MOVIE LED	G08910/15 52	OCA	39432/77 86	PICTURE	G94394/15 382
MINOR	06330/11 137	MOVIE LED	G08913/15 52	OCTAVIA	92708/76 576	PLANT	94923/35 535
MINOR	06334/11 137	MOVIE LED	G08931/15 52	OCTAVIA	92708/75 576	PLANT	94924/63 535
MINOR	06301T05 134	MOVIE LED	G08910/76 71	OCTAVIA	92736/75 502	PLATE	G93541/21 284
MINOR	06301T06 136	MOVIE LED	G08913/76 71	OCTAVIA	92736/76 502	PLAXICO	G30310/13 27
MINOR	06310T05 134	MOVIE LED	G08931/76 71	ODINE	94012/05 456	PLAXICO	G30335/13 27



Name / Art. Nr.	Page	Name / Art. Nr.	Page	Name / Art. Nr.	Page	Name / Art. Nr.	Page
PLAXICO	G30329/13 27	RAVENNA	G89361/31 493	SALVIA	G94232/75 407	SHIP	59574/30 212
PLUTO	G30558/13 480	RHODOS	90265/05 447	SAMURAI	G15591/13 376	SHIP	59596/30 213
PLUTO	G30510/13 14	RIDER	04347/75 256	SAMURAI	G15592/13 376	SHIP	59594/30 212
PLUTO	G30513/13 14	RIDER	04347/06 257	SAMURAI	G15593/13 376	SHIP	59548/05 211
PLUTO	G30534/13 14	RIDER	04358/75 256	SAMURAI	G15594/13 376	SHIP	59569/05 211
PLUTO	G30532/13 14	RIDER	04358/06 257	SANDNESS	93645/15 309	SHIP	59592/05 210
PLUTO	G30506/13 14	RIDER	04370/75 256	SANDNESS	93645/29 309	SHIP	59548/30 213
PLUTO	G30586/13 360	RIDER	04370/06 257	SANDNESS	93645/93 309	SHIP	59590/30 212
PLUTO	G30596/13 360	RIDER	G14910/06 96	SANDRA	85010/75 441	SHIRIN	G30110/15 26
PLUTO	G30535/13 14	RIDER	G14913/06 96	SANDRA	85010/76 441	SHIRIN	G30113/15 26
PLUTO	G30510/15 15	RIDER	G14932/06 96	SANDRA	G85029/05 108	SHIRIN	G30132/15 26
PLUTO	G30513/15 15	RIDER	14910/70 114	SANDRA	G85029/06 109	SHOOT	93599/13 224
PLUTO	G30534/15 15	RIDER	14913/70 114	SANDRA	G85031/05 108	SHOOT	93599/06 244
PLUTO	G30532/15 15	RIDER	14932/70 114	SANDRA	G85031/06 109	SHOOT	93664/06 244
PLUTO	G30506/15 15	RIGA	93643/15 310	SANDRA	G85091/05 108	SHOOT	93665/06 245
POLYGON	31970/63 252	RIGA	93642/15 310	SANDRA	G85091/06 109	SHOOT	93666/06 245
POLYGON	31970/35 252	RINGS	94944/70 250	SANNY	G15410/77 55	SHOOT	93667/06 245
POLYGON	31958/35 253	RINGS	94945/70 250	SANNY	G15413/77 55	SHOOT	93667/13 224
POLYGON	31949/35 253	RIVERSIDE	G93453/75 269	SANNY	G15432/77 55	SHOOT	93665/13 224
POP	01947/74 550	ROBIN	92900/94 552	SANNY	G15434/77 55	SHOOT	93666/13 224
POP	01947/78 550	ROBINIA	G74479/77 290	SANSIBAR	93646/75 254	SID	93676/29 326
PRIMO	61047/01 544	ROBINIA	G74471/77 290	SANSIBAR	93647/75 254	SILENCE	93558/05 323
PRIMO	61047/05 544	ROBINIA	G74476/77 290	SANSIBAR	93648/75 254	SILKE	G94142/13 435
PRIMO	61047/38 544	ROLANDA	G94222/75 414	SAO PAULO	G94145/15 410	SKIRT	94385/76 467
PRIMO	61047/28 544	ROM	94861/05 540	SASHA	94014/20 465	SKIRT	94385/15 467
PRIMO	61047/63 544	RONALD	94273/76 466	SASHA	94014/13 465	SKY	32049/15 174
PRIMO	61047/78 544	ROPE	93614/70 336	SATURN	G94245/15 388	SKY	32049/29 174
PRINCESS	55999P17 614	RORY	G35410/15 30	SATURNO	G64710/13 25	SKY	32072/29 173
PRINCESS	G55934/17 614	RORY	G35413/15 30	SATURNO	G64713/13 25	SKY	32072/15 172
PRINCESS	G55948/17 614	RORY	G35416/15 30	SATURNO	G64732/13 25	SKY	32010/15 175
PRINCESS	G55947/17 614	RORY	G35432/15 30	SCHNURPENDEL	93327/05 357	SKY	32010/29 175
PROVENCE	90168/20 459	ROUTE 66	94862/76 246	SCHNURPENDEL	93327/06 357	SKY	32070/15 172
PROVENCE	90169/20 459	ROUTE 66	94862/77 246	SCHNURPENDEL	93379/05 357	SKY	32070/29 173
PROVENCE	90168/05 458	ROUTE 66	94863/76 246	SCRIPT	G94398/77 417	SLASH	94426/13 471
PROVENCE	90169/05 458	ROUTE 66	94863/77 246	SCRIPT	G94399/77 417	SLASH	94426/05 471
PUCK	36429/05 140	RYAN	G57410/77 62	SEDNA	G36201/77 61	SLIDE	G94323/13 160
PUCK	36410/05 140	RYAN	G57413/77 62	SEDNA	G36210/77 61	SLIDE	G94947/13 160
PUCK	36434/05 140	RYAN	G57432/77 62	SEDNA	G36229/77 61	SLIDE	G94946/13 160
PURE	93557/06 323	<b>S</b>		SEDNA	G36230/77 61	SMOOTH	G20871/05 288
<b>Q</b>		SAILING	G93586/15 156	SEDNA	G36231/77 61	SMOOTH	G20872/05 289
QUADRI	94913/15 540	SAILING	G93644/15 156	SHADOW	94834/00 552	SMOOTH	G20873/05 289
QUASAR	G93641/13 280	SALAMANCA	G17942/15 157	SHELDON	G94812/75 561	SMOOTH	G20880/05 368
<b>R</b>		SALAMANCA	G17979/15 157	SHERWOOD	93649/00 343	SMOOTH	G20881/13 368
RACKET	94414/15 463	SALFORD	93590/70 332	SHIP	59593/05 210	SMOOTH	G20882/05 368
RAINBOW	73370A03 357	SALFORD	93590/29 327	SHIP	59576/05 210	SMOOTH	G20883/13 368
RAVENNA	G89361/13 492	SALFORD	93590/76 327	SHIP	59590/05 211	SMOOTH	G20884/13 369
RAVENNA	G89361/56 493	SALMA	93616/70 335	SHIP	59591/05 211	SMOOTH	G20885/05 369
RAVENNA	G89360/13 492	SALVIA	G94231/75 407	SHIP	59569/30 213	SMOOTH	G20886/13 369

Name / Art. Nr.	Page	Name / Art. Nr.	Page	Name / Art. Nr.	Page	Name / Art. Nr.	Page
SMOOTH	G20887/05 369	STATUS	60847/05 208	TIBO	76770/71 351	TREE	33330/35 122
SMOOTH	G20888/05 370	STATUS	60898/05 207	TIBO	76770/75 351	TREE	33331/35 122
SMOOTH	G20870/13 288	STELLA	38090/77 95	TIBO	76770/09 351	TREND	G93517/13 279
SOCCER	56299P74 615	STOCKHOLM	93650/00 311	TIMO	51847/05 227	TRIAL	93377/22 312
SOCCER	G56234/74 615	STOCKHOLM	93650/03 311	TIMO	51847/24 227	TRIBE	G33710/88 118
SOCCER	G56248/74 615	STORM	93651/70 251	TIMO	51847/75 227	TRIBE	G33729/88 118
SOCCER	G56247/74 615	STORM	93652/70 251	TIMO	51847/94 227	TRIBE	G33730/88 118
SOFIA	55310/77 89	STRAIGHT	G07030/77 411	TIMO	51848/05 227	TRIBE	G33735/88 118
SOFIA	55313/77 88	STRING	G93550/22 287	TIMO	51848/94 227	TROJA	93271/05 352
SOFIA	55316/77 88	STYLE II	G93505/15 265	TIMO	51870/75 226	TROLL	36310/05 141
SOFIA	55331/77 88	STYLE II	G93506/15 265	TIMO	51870/94 226	TROLL	36329/05 141
SOFIA	55334/77 88	SUN	93515/05 304	TIMO	51890/24 226	TROLL	36334/05 141
SOFIA	55390/77 89	SUN	93516/05 304	TIMO	51890/94 226	TRUST	G94320/15 415
SOFIA	55310/18 133	SUNNIVA	G93025/13 486	TIP	90214/11 444	TUBE	G61870/05 150
SOFIA	55310/19 131	SUNNIVA	G93026/13 486	TITANIC	93654/15 307	TUBE	G61890/05 150
SOFIA	55313/18 132	SUNRISE	G93536/21 285	TIZIAN	G94252/05 373	TUBE	G61858/05 151
SOFIA	55313/19 130	SUNRISE	G93535/21 285	TOGETHER	G94489/15 385	TUBE	G61849/05 150
SOFIA	55316/18 132	SUNRISE LIGHT	G93596/15 153	TONIA	G94224/78 430	TUNIS	90218/82 447
SOFIA	55316/19 130	SUNRISE LIGHT	G93653/15 153	TONIA	G94224/74 430	TYCHO	93594/76 329
SOFIA	55331/18 132	SUNSET	G90220/15 434	TONIA	G94224/70 430	TYPHOON	94492/70 473
SOFIA	55331/19 130	SUNSET	G90220/69 434	TONJA	G70579/15 273	TYPHOON	94491/70 473
SOFIA	55334/18 132	SUNSET	G90220/58 434	TONJA	G70573/15 273	<b>U</b>	
SOFIA	55334/19 130	SURF	G93510/13 277	TOPIC	G94322/15 378	UMBRELLA	94948/63 534
SOFIA	55390/18 133	SURF	G93511/13 277	TORANA	94411/06 467	URANUS	G33806/15 18
SOFIA	55390/19 131	SVEA	G94155/15 402	TORBOLE	73678/72 352	URANUS	G33810/15 18
SOFT	G94488/05 399	SYNERGY	93592/29 241	TORRES	93615/70 336	URANUS	G33813/15 18
SOLUTION	G94392/05 399	SYNERGY	93593/76 241	TORSION	G32210/15 20	URANUS	G33816/15 18
SOLUTION	G94393/05 399	<b>T</b>		TORSION	G32229/15 20	URANUS	G33832/15 18
SONIAN	90323/13 445	TANEL	G94668/05 599	TORSION	G32230/15 20	URANUS	G33806/13 17
SONIAN	90324/13 445	TANIEL	G94667/05 598	TORSION	G32235/15 20	URANUS	G33810/13 16
SPARI 4	93008/05 497	TANIEL	G94667/13 598	TOULOUSE	90166/20 459	URANUS	G33813/13 16
SPARI 4	93008/76 497	TARGET	G18810/77 24	TOULOUSE	90166/05 458	URANUS	G33816/13 16
SPARI LED	G98810/05 489	TARGET	G18829/77 24	TOULOUSE	90167/05 458	URANUS	G33832/13 17
SPARI LED	G98811/05 489	TARGET	G18830/77 24	TOULOUSE	90167/20 459	URANUS	G33835/13 16
SPOCK	94166/13 435	TARGET	G18835/77 24	TOWN	94080/76 468	URANUS	G33804/13 17
STAIRS	G15206/77 23	TARIFA	62447/05 546	TRAFFIC	G94490/15 383	URANUS	G33896/13 360
STAIRS	G15210/77 23	TEIDE	G94380/05 396	TRANSIT	G67410/21 40	<b>V</b>	
STAIRS	G15229/77 23	TEIDE	G94380/30 396	TRANSIT	G67429/21 40	VEGAS	17674/15 184
STAIRS	G15232/77 23	THALASSA	G93031/15 275	TRANSIT	G67430/21 40	VEGAS	17674/79 182
STAIRS	G15234/77 23	THERON	34410/15 77	TRANSIT	G67435/21 40	VEGAS	17675/79 182
STATUS	60895/05 207	THERON	34413/15 77	TRANSIT	G67495/21 40	VEGAS	17690/79 183
STATUS	60880/05 207	THERON	34432/15 77	TRANSIT	G67473/21 286	VEGAS	17693/15 185
STATUS	60873/05 206	THERON	34493/15 77	TREE	33310/50 123	VEGAS	17693/79 183
STATUS	60877/05 206	TIARA	15610/13 85	TREE	33329/50 123	VEGAS	17690/15 185
STATUS	60848/05 208	TIARA	15613/13 85	TREE	33330/50 123	VEGAS	17675/15 184
STATUS	60890/05 207	TIARA	15634/13 85	TREE	33331/50 123	VEGAS	17695/79 183
STATUS	60858/05 209	TIARA	15632/13 85	TREE	33310/35 122	VEGAS	17695/15 185
STATUS	60875/05 206	TIBO	76770/51 351	TREE	33329/35 122	VENEDIG	G92926/01 572

Name / Art. Nr.	Page	Name / Art. Nr.	Page
VENEDIG	G92926/03 572	WATERFALL	93657/93 176
VENEDIG	G92926/05 572	WATERFALL	93658/93 176
VENEDIG	G92926/06 572	WAY	G94324/13 387
VENEDIG	G92926/11 572	WEGA	24510/15 79
VENTI	G94402/13 383	WEGA	24529/15 79
VENUS	G93655/15 260	WEGA	24532/15 79
VESSA	92940/75 504	WEGA	24534/15 79
VIEW	G93537/15 152	WEGA	24547/15 553
VIEW	G93538/15 152	WESLEY	G54810/77 56
VIEW	G93556/15 152	WESLEY	G54813/77 56
VIEW	G93568/15 152	WESLEY	G54834/77 56
VIGOR	G94131/05 428	WESLEY	G54832/77 56
VIGOR	G94141/05 428	WESLEY	G54816/77 56
VIGOR	G94141/11 429	WHITE BALL	35610/05 102
VIGOR	G94151/05 428	WHITE BALL	35634/05 102
VIGOR	G94158/05 429	WHITE BALL	35631/05 102
VIGOR	G94131/11 429	WIDOW	HK12496S70 506
VIRGINIA	G94404A15 412	WIDOW	94916/05 506
VIRGINIA	G94405A15 412	WINDOW	G19035/13 59
VIRGO	G02210/15 93	WINDOW	G19091/13 58
VIRGO	G02213/15 93	WINDOW	G19092/13 58
VIRGO	G02231/15 93	WINDOW	G19093/13 58
VIRGO	G02233/15 93	WINDOW	G19094/13 58
VIRGO	G02235/15 204	WINDOW	G19095/13 59
VIRGO	G02242/15 204	WINSTON	92710/05 503
VIRGO	G02259/15 204	WINSTON	92710/06 503
VIRGO	G02292/15 204	WOODDESIGN	93659/35 342
VIRGO	G02295/15 205	WOODDESIGN	93660/35 342
VIRGO	G02299/15 205	WORLD	G10430/15 409
VIRGO	02210/20 126	WORLD	G10431/15 409
VIRGO	02213/20 126	WORLD	G10435/15 409
VIRGO	02231/20 126	WORLD	G10406/15 409
VIRGO	02233/20 126	WORLD	G10429/15 409
VISION	G94326/15 385	WOW	93559/05 322
VOGUE	G33991/15 380	WRAP	G93543/15 386
VOGUE	G33993/15 380	Y	
VOGUE	G33995/15 380	YORKSHIRE	94921/35 532
VULCANO	94433/05 216	YORKSHIRE	94922/35 532
VULCANO	94434/05 216	YUNAN	G94348/15 388
VULCANO	94433/65 217	Z	
VULCANO	94434/65 217	ZARINA	93219/13 314
VULKAN	G94325/05 397	ZEBRA	94425/05 470
W		ZEBRA	94425/15 470
WALK	G20410/13 37	ZIG ZAG	92728/15 579
WALK	G20413/13 37	ZOEY	G57510/75 35
WALK	G20432/13 37	ZOEY	G57513/75 35
WALK	G20433/13 37	ZOEY	G57532/75 35
WATERFALL	93656/93 176		

Name / Art. Nr.	Page	Name / Art. Nr.	Page	Name / Art. Nr.	Page	Name / Art. Nr.	Page
<b>O</b>		<b>07713/77</b>	INA	90	<b>G08599/21</b>	CROSSING	411
<b>00206/15</b>	JOYA	199	<b>07732/77</b>	INA	90	<b>G08910/15</b>	MOVIE LED
<b>00210/15</b>	JOYA	199	<b>07734/77</b>	INA	90	<b>G08910/76</b>	MOVIE LED
<b>00213/15</b>	JOYA	199	<b>07770/05</b>	INA	350	<b>G08913/15</b>	MOVIE LED
<b>00233/15</b>	JOYA	199	<b>07770/06</b>	INA	350	<b>G08913/76</b>	MOVIE LED
<b>00293/15</b>	JOYA	198	<b>07810/15</b>	MOVIE	91	<b>G08931/15</b>	MOVIE LED
<b>00299/15</b>	JOYA	198	<b>07813/15</b>	MOVIE	91	<b>G08931/76</b>	MOVIE LED
<b>01947/74</b>	POP	550	<b>07831/15</b>	MOVIE	91		<b>17695/79</b>
<b>01947/78</b>	POP	550	<b>09958A75</b>	CARLYN	508	<b>10510/05</b>	BONA
<b>02210/20</b>	VIRGO	126	<b>G02210/15</b>	VIRGO	93	<b>10513/05</b>	BONA
<b>02213/20</b>	VIRGO	126	<b>G02213/15</b>	VIRGO	93	<b>10532/05</b>	BONA
<b>02231/20</b>	VIRGO	126	<b>G02231/15</b>	VIRGO	93	<b>10534/05</b>	BONA
<b>02233/20</b>	VIRGO	126	<b>G02233/15</b>	VIRGO	93	<b>10548/05</b>	BONA
<b>02747/05</b>	ISI	549	<b>G02235/15</b>	VIRGO	204	<b>10570/05</b>	BONA
<b>02747/20</b>	ISI	548	<b>G02242/15</b>	VIRGO	204	<b>10578/05</b>	BONA
<b>02747/22</b>	ISI	548	<b>G02259/15</b>	VIRGO	204	<b>10599/05</b>	BONA
<b>02747/23</b>	ISI	548	<b>G02292/15</b>	VIRGO	204	<b>10802/01</b>	HOBBY
<b>02747/63</b>	ISI	548	<b>G02295/15</b>	VIRGO	205	<b>10802/05</b>	HOBBY
<b>02747/71</b>	ISI	549	<b>G02299/15</b>	VIRGO	205	<b>10802/06</b>	HOBBY
<b>02747/78</b>	ISI	549	<b>G02893/82</b>	ASTA 30	606	<b>10802/11</b>	HOBBY
<b>04347/06</b>	RIDER	257	<b>G03090/73</b>	COSA 15	606	<b>11170/11</b>	BISTRO
<b>04347/75</b>	RIDER	256	<b>G03090/75</b>	COSA 15	606	<b>12848/13</b>	BOSTON
<b>04358/06</b>	RIDER	257	<b>G03090/82</b>	COSA 15	606	<b>12858/13</b>	BOSTON
<b>04358/75</b>	RIDER	256	<b>G03093/73</b>	COSA 30	607	<b>12870/13</b>	BOSTON
<b>04370/06</b>	RIDER	257	<b>G03093/75</b>	COSA 30	607	<b>12871/13</b>	BOSTON
<b>04370/75</b>	RIDER	256	<b>G03093/82</b>	COSA 30	607	<b>12876/13</b>	BOSTON
<b>05910/75</b>	CAT	469	<b>G03094/75</b>	COSA 45	607	<b>12910/20</b>	GABON
<b>05998/75</b>	CAT	469	<b>G04070/15</b>	DONUT	146	<b>12913/20</b>	GABON
<b>06301T05</b>	MINOR	134	<b>G04073/15</b>	DONUT	144	<b>12934/20</b>	GABON
<b>06301T06</b>	MINOR	136	<b>G04076/15</b>	DONUT	146	<b>13247/05</b>	CLARIE
<b>06310/11</b>	MINOR	137	<b>G04090/15</b>	DONUT	144	<b>13247/06</b>	CLARIE
<b>06310T05</b>	MINOR	134	<b>G04091/15</b>	DONUT	147	<b>13247/22</b>	CLARIE
<b>06310T06</b>	MINOR	136	<b>G04095/15</b>	DONUT	147	<b>13258/05</b>	CLARIE
<b>06311/05</b>	MINOR	134	<b>G05505/77</b>	GIORGIA	45	<b>13258/22</b>	CLARIE
<b>06329/11</b>	MINOR	137	<b>G05511/77</b>	GIORGIA	45	<b>13291/05</b>	CLARIE
<b>06329T05</b>	MINOR	135	<b>G05529/77</b>	GIORGIA	45	<b>13291/06</b>	CLARIE
<b>06329T06</b>	MINOR	136	<b>G05532/77</b>	GIORGIA	45	<b>13291/22</b>	CLARIE
<b>06330/11</b>	MINOR	137	<b>G05535/77</b>	GIORGIA	45	<b>14910/70</b>	RIDER
<b>06330T05</b>	MINOR	135	<b>G05573/77</b>	GIORGIA	291	<b>14913/70</b>	RIDER
<b>06330T06</b>	MINOR	136	<b>G07030/77</b>	STRAIGHT	411	<b>14932/70</b>	RIDER
<b>06334/11</b>	MINOR	137	<b>G07110/77</b>	OPALINA	34	<b>15610/13</b>	TIARA
<b>06334T05</b>	MINOR	135	<b>G07116/77</b>	OPALINA	34	<b>15613/13</b>	TIARA
<b>06334T06</b>	MINOR	136	<b>G07131/77</b>	OPALINA	34	<b>15632/13</b>	TIARA
<b>07501T05</b>	COSMOS	138	<b>G08511/21</b>	CROSSING	41	<b>15634/13</b>	TIARA
<b>07510T05</b>	COSMOS	138	<b>G08529/21</b>	CROSSING	41	<b>17347/15</b>	BULBY
<b>07529T05</b>	COSMOS	138	<b>G08530/21</b>	CROSSING	41	<b>17370/15</b>	BULBY
<b>07534T05</b>	COSMOS	138	<b>G08535/21</b>	CROSSING	41	<b>17674/15</b>	VEGAS
<b>07710/77</b>	INA	90	<b>G08573/21</b>	CROSSING	286	<b>17674/79</b>	VEGAS
						<b>17675/15</b>	VEGAS
						<b>17675/79</b>	VEGAS
						<b>17690/15</b>	VEGAS
						<b>17690/79</b>	VEGAS
						<b>17693/15</b>	VEGAS
						<b>17693/79</b>	VEGAS
						<b>17695/15</b>	VEGAS
						<b>17810/56</b>	MILOS
						<b>17829/56</b>	MILOS
						<b>17832/56</b>	MILOS
						<b>17834/56</b>	MILOS
						<b>18048/79</b>	MAGIC
						<b>18070/79</b>	MAGIC
						<b>18073/79</b>	MAGIC
						<b>18074/79</b>	MAGIC
						<b>18075/79</b>	MAGIC
						<b>18093/79</b>	MAGIC
						<b>18095/79</b>	MAGIC
						<b>18110/15</b>	CHARLIE
						<b>18113/15</b>	CHARLIE
						<b>18193/15</b>	CHARLIE
						<b>18196/15</b>	CHARLIE
						<b>G10406/15</b>	WORLD
						<b>G10429/15</b>	WORLD
						<b>G10430/15</b>	WORLD
						<b>G10431/15</b>	WORLD
						<b>G10435/15</b>	WORLD
						<b>G10910/75</b>	CINDA LED
						<b>G10929/75</b>	CINDA LED
						<b>G10934/75</b>	CINDA LED
						<b>G11410/15</b>	MOUNTAIN
						<b>G11429/15</b>	MOUNTAIN
						<b>G11430/15</b>	MOUNTAIN
						<b>G11431/15</b>	MOUNTAIN
						<b>G11435/15</b>	MOUNTAIN
						<b>G12211/77</b>	COMB
						<b>G12213/77</b>	COMB
						<b>G12232/77</b>	COMB
						<b>G12234/77</b>	COMB
						<b>G13610/15</b>	MORE
						<b>G13613/15</b>	MORE
						<b>G13632/15</b>	MORE
						<b>G13633/15</b>	MORE
						<b>G14710/15</b>	MAIRA
						<b>G14772/15</b>	MAIRA
						<b>G14773/15</b>	MAIRA
						<b>G14776/15</b>	MAIRA

Name / Art. Nr.	Page	Name / Art. Nr.	Page	Name / Art. Nr.	Page	Name / Art. Nr.	Page
G14910/06 RIDER	96	G18810/77 TARGET	24	23073/50 NATURE	345	27160/13 DARLINGTON	496
G14913/06 RIDER	96	G18829/77 TARGET	24	23074/35 NATURE	344	27161/13 DARLINGTON	496
G14932/06 RIDER	96	G18830/77 TARGET	24	23074/50 NATURE	345	28551/58 AREZZO	463
G15206/77 STAIRS	23	G18835/77 TARGET	24	23110/35 FOREST	120	29210/15 NOBLE	186
G15210/77 STAIRS	23	G19035/13 WINDOW	59	23129/35 FOREST	120	29230/15 NOBLE	186
G15229/77 STAIRS	23	G19091/13 WINDOW	58	23130/35 FOREST	120	29235/15 NOBLE	186
G15232/77 STAIRS	23	G19092/13 WINDOW	58	23131/35 FOREST	120	G20410/13 WALK	37
G15234/77 STAIRS	23	G19093/13 WINDOW	58	23410/50 FORT	121	G20413/13 WALK	37
G15410/77 SANNY	55	G19094/13 WINDOW	58	23429/50 FORT	121	G20432/13 WALK	37
G15413/77 SANNY	55	G19095/13 WINDOW	59	23430/50 FORT	121	G20433/13 WALK	37
G15432/77 SANNY	55	G19191/15 DOORS RO.	374	23431/50 FORT	121	G20870/13 SMOOTH	288
G15434/77 SANNY	55	G19192/15 DOORS RO.	374	23710/70 JESPER	249	G20871/05 SMOOTH	288
G15591/13 SAMURAI	376	G19193/15 DOORS RO.	374	23749/70 JESPER	249	G20872/05 SMOOTH	289
G15592/13 SAMURAI	376	G19194/15 DOORS RO.	374	23758/70 JESPER	249	G20873/05 SMOOTH	289
G15593/13 SAMURAI	376	G19195/15 DOORS RO.	374	23770/70 JESPER	248	G20880/05 SMOOTH	368
G15594/13 SAMURAI	376	HK12496S70 WIDOW	506	23771/70 JESPER	248	G20881/13 SMOOTH	368
G16291/13 DOORS SQ.	375	HK12707S05 INBAL	318	24510/15 WEGA	79	G20882/05 SMOOTH	368
G16292/13 DOORS SQ.	375	HK12707S06 INBAL	318	24529/15 WEGA	79	G20883/13 SMOOTH	368
G16293/13 DOORS SQ.	375	HK13018S70 CINE	501	24532/15 WEGA	79	G20884/13 SMOOTH	369
G16294/13 DOORS SQ.	375	HK13021S13 PHAROS	319	24534/15 WEGA	79	G20885/05 SMOOTH	369
G16295/13 DOORS SQ.	375	2		24547/15 WEGA	553	G20886/13 SMOOTH	369
G16310/13 PHILO	48	21010/76 DALMA	112	24705/11 FLEX	588	G20887/05 SMOOTH	369
G16313/13 PHILO	48	21013/76 DALMA	112	24705/37 FLEX	588	G20888/05 SMOOTH	370
G16332/13 PHILO	48	21034/76 DALMA	112	24705/72 FLEX	588	G21510/13 AMALFI LED	63
G16334/13 PHILO	48	21048/76 DALMA	242	24705T05 FLEX	588	G21513/13 AMALFI LED	63
G16348/13 PHILO	166	21059/76 DALMA	242	24705T06 FLEX	588	G21532/13 AMALFI LED	63
G16348/18 PHILO	166	21074/76 DALMA	242	24910/75 AZTEKAS	106	G21534/13 AMALFI LED	63
G16358/13 PHILO	166	21094/76 DALMA	113	24910/85 AZTEKAS	107	G21610/15 MAGNITO LED	50
G16358/18 PHILO	166	21096/76 DALMA	113	24913/75 AZTEKAS	106	G21629/15 MAGNITO LED	50
G16372/13 PHILO	167	21210/15 BULB	78	24913/85 AZTEKAS	107	G21631/15 MAGNITO LED	50
G16394/13 PHILO	48	21213/15 BULB	78	24932/75 AZTEKAS	106	G21635/15 MAGNITO LED	50
G16891/13 FASHION SQ.	395	21216/15 BULB	78	24932/85 AZTEKAS	107	G21710/22 MILANO LED	73
G16893/13 FASHION SQ.	395	21258/15 BULB	192	24970/75 AZTEKAS	215	G21710/75 MILANO LED	72
G16895/13 FASHION SQ.	395	21412/05 MORATO	455	24970/85 AZTEKAS	215	G21710/76 MILANO LED	51
G16991/13 FASHION RO.	394	21412/06 MORATO	455	24991/75 AZTEKAS	215	G21713/22 MILANO LED	73
G16993/13 FASHION RO.	394	22510/15 FONDA	202	24991/85 AZTEKAS	215	G21713/75 MILANO LED	72
G16995/13 FASHION RO.	394	22534/15 FONDA	202	26810/76 BENTLI	117	G21713/76 MILANO LED	51
G17449/13 PERFECT	566	22548/15 FONDA	203	26824/76 BENTLI	117	G21732/22 MILANO LED	73
G17456/13 PERFECT	499	22559/15 FONDA	203	26834/76 BENTLI	117	G21732/75 MILANO LED	72
G17570/13 BETTER	278	22574/15 FONDA	203	26910/15 DATE	191	G21732/76 MILANO LED	51
G17572/13 BETTER	278	22595/15 FONDA	202	26970/15 DATE	191	G21734/22 MILANO LED	73
G17573/13 BETTER	278	22670/15 CINTA	197	26973/15 DATE	190	G21734/75 MILANO LED	72
G17942/15 SALAMANCA	157	22710/15 MARTU	247	26974/15 DATE	191	G21734/76 MILANO LED	51
G17979/15 SALAMANCA	157	22770/15 MARTU	247	26995/15 DATE	190	G21906/15 CELEST	29
G18310/76 JUPP LED	54	22790/15 MARTU	247	27010/05 DIFFERENT	104	G21910/15 CELEST	29
G18313/76 JUPP LED	54	23070/35 NATURE	344	27030/05 DIFFERENT	104	G21913/15 CELEST	29
G18332/76 JUPP LED	54	23070/50 NATURE	345	27035/05 DIFFERENT	104	G21932/15 CELEST	29
G18334/76 JUPP LED	54	23073/35 NATURE	344	27091/05 DIFFERENT	105	G22610/15 CINTA	76

Name / Art. Nr.	Page	Name / Art. Nr.	Page	Name / Art. Nr.	Page	Name / Art. Nr.	Page				
G22613/15	CINTA	76	32070/15	SKY	172	37934/76	KORA	99	G32459/77	LEA	165
G22632/15	CINTA	76	32070/29	SKY	173	38090/77	STELLA	95	G32473/77	LEA	165
G22642/15	CINTA	197	32072/15	SKY	172	38776/13	JANIS	301	G33710/88	TRIBE	118
G22659/15	CINTA	197	32072/29	SKY	173	38942/15	EODE	195	G33729/88	TRIBE	118
G22692/15	CINTA	197	33310/35	TREE	122	38959/15	EODE	195	G33730/88	TRIBE	118
G22693/15	CINTA	196	33310/50	TREE	123	38992/15	EODE	194	G33735/88	TRIBE	118
G22694/15	CINTA	196	33329/35	TREE	122	38994/15	EODE	194	G33804/13	URANUS	17
G22695/15	CINTA	196	33329/50	TREE	123	38998/15	EODE	194	G33806/13	URANUS	17
G24801A05	LEO	574	33330/35	TREE	122	39411/77	OCA	86	G33806/15	URANUS	18
G24801A06	LEO	574	33330/50	TREE	123	39429/77	OCA	86	G33810/13	URANUS	16
G26110/77	BEAUTY	22	33331/35	TREE	122	39432/77	OCA	86	G33810/15	URANUS	18
G26113/77	BEAUTY	22	33331/50	TREE	123	39434/77	OCA	86	G33813/13	URANUS	16
G26131/77	BEAUTY	22	34410/15	THERON	77	39510/56	LAVA	124	G33813/15	URANUS	18
G26133/77	BEAUTY	22	34413/15	THERON	77	39510/77	LAVA	94	G33816/13	URANUS	16
G26210/77	BENKO	39	34432/15	THERON	77	39513/56	LAVA	124	G33816/15	URANUS	18
G26229/77	BENKO	39	34493/15	THERON	77	39513/77	LAVA	94	G33832/13	URANUS	17
G26230/77	BENKO	39	34810/15	LEEDS	81	39516/56	LAVA	124	G33832/15	URANUS	18
G26310/70	BENTE	116	34829/15	LEEDS	81	39516/77	LAVA	94	G33835/13	URANUS	16
G26324/70	BENTE	116	34831/15	LEEDS	81	39532/56	LAVA	124	G33896/13	URANUS	360
G26334/70	BENTE	116	35610/05	WHITE BALL	102	39532/77	LAVA	94	G33991/15	VOGUE	380
G28691/15	FORMULAR	427	35631/05	WHITE BALL	102	G30110/15	SHIRIN	26	G33993/15	VOGUE	380
G28692/15	FORMULAR	427	35634/05	WHITE BALL	102	G30113/15	SHIRIN	26	G33995/15	VOGUE	380
G28693/15	FORMULAR	427	35810/56	LUCA	129	G30132/15	SHIRIN	26	G34610/15	NARCISSA	32
G28694/15	FORMULAR	427	35810/77	LUCA	87	G30310/13	PLAXICO	27	G34629/15	NARCISSA	32
G28810/05	LOONA	66	35812/77	LUCA	87	G30329/13	PLAXICO	27	G34635/15	NARCISSA	32
G28810/13	LOONA	64	35813/56	LUCA	129	G30335/13	PLAXICO	27	G34710/77	KASSANDRA	57
G28813/05	LOONA	66	35813/77	LUCA	87	G30506/13	PLUTO	14	G34729/77	KASSANDRA	57
G28813/13	LOONA	64	35816/56	LUCA	129	G30506/15	PLUTO	15	G34735/77	KASSANDRA	57
G28832/05	LOONA	66	35816/77	LUCA	87	G30510/13	PLUTO	14	G35410/15	RORY	30
G28832/13	LOONA	64	35832/56	LUCA	129	G30510/15	PLUTO	15	G35413/15	RORY	30
G28833/13	LOONA	65	35832/77	LUCA	87	G30513/13	PLUTO	14	G35416/15	RORY	30
G28834/05	LOONA	66	36310/05	TROLL	141	G30513/15	PLUTO	15	G35432/15	RORY	30
G28834/13	LOONA	64	36329/05	TROLL	141	G30532/13	PLUTO	14	G35710/15	PACOME	42
G28840/13	LOONA	65	36334/05	TROLL	141	G30532/15	PLUTO	15	G35713/15	PACOME	42
G28842/13	LOONA	65	36410/05	PUCK	140	G30534/13	PLUTO	14	G35793/15	PACOME	42
G29091/15	MAGELLAN	362	36429/05	PUCK	140	G30534/15	PLUTO	15	G35795/15	PACOME	42
G29092/15	MAGELLAN	362	36434/05	PUCK	140	G30535/13	PLUTO	14	G36201/77	SEDNA	61
G29093/15	MAGELLAN	362	37910/52	KORA	100	G30558/13	PLUTO	480	G36210/77	SEDNA	61
G29094/15	MAGELLAN	362	37910/71	KORA	101	G30586/13	PLUTO	360	G36229/77	SEDNA	61
<b>3</b>			37910/75	KORA	98	G30596/13	PLUTO	360	G36230/77	SEDNA	61
31949/35	POLYGON	253	37910/76	KORA	99	G32210/15	TORSION	20	G36231/77	SEDNA	61
31958/35	POLYGON	253	37924/52	KORA	100	G32229/15	TORSION	20	G36810/77	HEDA	33
31970/35	POLYGON	252	37924/71	KORA	101	G32230/15	TORSION	20	G36813/77	HEDA	33
31970/63	POLYGON	252	37924/75	KORA	98	G32235/15	TORSION	20	G36832/77	HEDA	33
32010/15	SKY	175	37924/76	KORA	99	G32410/77	LEA	44	G37410/77	FRAME	60
32010/29	SKY	175	37934/52	KORA	100	G32429/77	LEA	44	G37429/77	FRAME	60
32049/15	SKY	174	37934/71	KORA	101	G32432/77	LEA	44	G37430/77	FRAME	60
32049/29	SKY	174	37934/75	KORA	98	G32434/77	LEA	44	G37431/77	FRAME	60



Name / Art. Nr.	Page	Name / Art. Nr.	Page	Name / Art. Nr.	Page	Name / Art. Nr.	Page
G38110/15	28	55334/19	130	G56248/74	615	G67473/21	286
G38113/15	28	55334/77	88	G57410/77	62	G67495/21	40
G38132/15	28	55390/18	133	G57413/77	62	<b>7</b>	
G38134/15	28	55390/19	131	G57432/77	62	70170/13	353
G38811/13	67	55390/77	89	G57510/75	35	70970/70	357
G38813/13	67	55999P17	614	G57513/75	35	71170A02	356
G38816/13	67	56070/72	613	G57532/75	35	71170A03	356
G38832/13	67	56099P72	613	<b>6</b>		71170A05	356
G39210/15	53	56299P74	615	60847/05	208	71170A07	356
G39230/15	53	56478/05	355	60848/05	208	73370A03	357
G39234/15	53	57610/70	125	60858/05	209	73578/13	352
G39642/75	164	57629/70	125	60873/05	206	73678/72	352
G39654/75	164	57632/70	125	60875/05	206	74270/05	353
G39695/75	164	57634/70	125	60877/05	206	76770/09	351
<b>4</b>		59548/05	211	60880/05	207	76770/51	351
G46110/77	46	59548/30	213	60890/05	207	76770/71	351
G46112/77	46	59569/05	211	60895/05	207	76770/75	351
G46113/77	46	59569/30	213	60898/05	207	77347/20	238
G46116/77	46	59574/30	212	61047/01	544	77371/20	238
G46132/77	46	59576/05	210	61047/05	544	77379/20	238
<b>5</b>		59590/05	211	61047/28	544	78270/01	354
50410/15	80	59590/30	212	61047/38	544	78270/04	354
50416/15	80	59591/05	211	61047/63	544	78270/05	354
50434/15	80	59592/05	210	61047/78	544	78270/11	354
51847/05	227	59593/05	210	62447/05	546	78270/73	354
51847/24	227	59594/30	212	65010/77	82	78270/78	354
51847/75	227	59596/30	213	65013/77	82	G70573/15	273
51847/94	227	G53500A05	474	65034/77	82	G70579/15	273
51848/05	227	G53500A75	474	66472/43	320	G74471/77	290
51848/94	227	G53501A05	474	66747/76	239	G74476/77	290
51870/75	226	G53501A75	474	66773/76	239	G74479/77	290
51870/94	226	G54810/77	56	66792/76	239	G77710/05	69
51890/24	226	G54813/77	56	67347/56	556	G77710/06	68
51890/94	226	G54816/77	56	67347/75	556	G77729/05	69
53524A05	474	G54832/77	56	G61849/05	150	G77729/06	68
55310/18	133	G54834/77	56	G61858/05	151	G77732/05	69
55310/19	131	G55210/77	47	G61870/05	150	G77732/06	68
55310/77	89	G55213/77	47	G61890/05	150	G77734/05	69
55313/18	132	G55232/77	47	G64710/13	25	G77734/06	68
55313/19	130	G55234/77	47	G64713/13	25	<b>8</b>	
55313/77	88	G55934/17	614	G64732/13	25	81910/58	236
55316/18	132	G55947/17	614	G65142/21	162	81949/58	237
55316/19	130	G55948/17	614	G65156/21	162	81970/58	236
55316/77	88	G56034/72	612	G65172/21	162	81971/58	236
55331/18	132	G56047/72	612	G67410/21	40	85010/75	441
55331/19	130	G56048/72	612	G67429/21	40	85010/76	441
55331/77	88	G56234/74	615	G67430/21	40	G85029/05	108
55334/18	132	G56247/74	615	G67435/21	40	G85029/06	109



Name / Art. Nr.	Page	Name / Art. Nr.	Page	Name / Art. Nr.	Page	Name / Art. Nr.	Page
G85031/05 SANDRA	108	90218/82 TUNIS	447	92929/77 LILLE	557	93512/05 MAILAND	220
G85031/06 SANDRA	109	90238/05 ISAR	454	92931/73 BORGIO	586	93513/05 MAILAND	220
G85091/05 SANDRA	108	90239/05 ISAR	454	92931/74 BORGIO	586	93514/05 MAILAND	220
G85091/06 SANDRA	109	90240/05 ISAR	454	92931/78 BORGIO	586	93515/05 SUN	304
G89360/13 RAVENNA	492	90241/05 ISAR	454	92940/75 VESSA	504	93516/05 SUN	304
G89361/13 RAVENNA	492	90265/05 RHODOS	447	92958/00 ALHAMBRA	554	93518/75 FIRST	303
G89361/31 RAVENNA	493	90266/82 ELYSEE	444	92958/75 ALHAMBRA	554	93522/05 ANDRIA	439
G89361/56 RAVENNA	493	90267/82 ELYSEE	444	92961/05 BECCA	513	93522/20 ANDRIA	438
<b>9</b>		90288/11 LIVORNO	447	92975/01 FUERTE	525	93522/63 ANDRIA	440
90007B15 MORRIS	443	90323/13 SONIAN	445	92975/03 FUERTE	525	93532/15 DUBAI	188
90010/13 ANDALUZ	442	90324/13 SONIAN	445	92975/05 FUERTE	525	93546/05 COPPA	349
90011/13 ANDALUZ	442	90339/13 KYRA	444	92975/08 FUERTE	525	93552/31 COPPRA	328
90078/05 GIBRALTAR	447	92603/75 NERVA	512	92984/06 HANDY	526	93553/15 JOKER	297
90100/05 DJERBA	453	92603/80 BIRDS	613	93008/05 SPARI 4	497	93554/15 JOKER	297
90101/05 DJERBA	453	92603/81 NERVA	512	93008/76 SPARI 4	497	93557/06 PURE	323
90102/05 DJERBA	453	92604/03 JENNY	582	93020/71 LUCIE	514	93558/05 SILENCE	323
90103/03 MAURITIUS	452	92604/04 JENNY	582	93020/73 LUCIE	514	93559/05 WOW	322
90103/05 MAURITIUS	452	92604/07 JENNY	582	93020/74 LUCIE	514	93560/22 HORIZONT	322
90103/07 MAURITIUS	460	92604/11 JENNY	582	93034/05 JERSEY	494	93561/70 NORTH	348
90103/20 MAURITIUS	460	92604/78 JENNY	582	93034/06 JERSEY	494	93561/75 NORTH	348
90104/03 MAURITIUS	452	92645/15 NEREIDE	505	93034/58 JERSEY	494	93562/70 HOMELY	347
90104/05 MAURITIUS	452	92645/29 NEREIDE	505	93219/13 ZARINA	314	93563/22 INDEPENDENT	229
90104/07 MAURITIUS	460	92679/31 BANKIR	580	93220/05 FREYA	352	93564/22 INDEPENDENT	229
90104/20 MAURITIUS	460	92706/06 HENRY	579	93232/09 BUMBLE	316	93580/05 ANDRIA	439
90105/03 MAURITIUS	452	92706/15 HENRY	579	93248/77 MONA	306	93580/20 ANDRIA	438
90105/05 MAURITIUS	452	92708/75 OCTAVIA	576	93249/77 MONA	306	93581/05 ANDRIA	439
90105/07 MAURITIUS	460	92708/76 OCTAVIA	576	93250/00 INDY	351	93581/20 ANDRIA	438
90105/20 MAURITIUS	460	92709/06 MOVIE	526	93271/05 TROJA	352	93582/15 ICEDROP	218
90166/05 TOULOUSE	458	92710/05 WINSTON	503	93275/05 FANTASIA	305	93583/15 ICEDROP	219
90166/20 TOULOUSE	459	92710/06 WINSTON	503	93277/05 FANTASIA	305	93584/15 GHOST	294
90167/05 TOULOUSE	458	92728/15 ZIG ZAG	579	93327/05 SCHNURPENDEL	357	93585/15 DUBAI	188
90167/20 TOULOUSE	459	92732/06 LOMÉ	547	93327/06 SCHNURPENDEL	357	93588/70 FLEETWOOD	332
90168/05 PROVENCE	458	92732/75 LOMÉ	547	93374/05 CLARIE	232	93589/70 GRIMSBY	332
90168/20 PROVENCE	459	92736/75 OCTAVIA	502	93374/06 CLARIE	234	93590/29 SALFORD	327
90169/05 PROVENCE	458	92736/76 OCTAVIA	502	93374/22 CLARIE	233	93590/70 SALFORD	332
90169/20 PROVENCE	459	92752/00 EVERGREEN	520	93377/22 TRIAL	312	93590/76 SALFORD	327
90181/35 FIDSCHI	461	92762/01 JAN	581	93379/05 SCHNURPENDEL	357	93592/29 SYNERGY	241
90181/36 FIDSCHI	461	92762/05 JAN	581	93388/05 ALMIRA	350	93593/76 SYNERGY	241
90186/35 FIDSCHI	461	92762/06 JAN	581	93388/06 ALMIRA	350	93594/76 TYCHO	329
90186/36 FIDSCHI	461	92789/76 METTLE	501	93415/05 GLITZ	313	93595/76 CORIOLIS	329
90191/05 MIRAMAR	450	92852/00 EVERGREEN	520	93429/15 BULB	192	93597/29 HIPPOLYTE	330
90191/13 MIRAMAR	451	92900/94 ROBIN	552	93444/70 ANOUK	334	93599/06 SHOOT	244
90191/15 MIRAMAR	450	92907/01 PAOLO	545	93460/76 MAYFAIR	328	93599/13 SHOOT	224
90196/05 MIRAMAR	450	92907/04 PAOLO	545	93461/05 KINLEY	464	93600/15 LUNAO	302
90196/13 MIRAMAR	451	92907/20 PAOLO	545	93461/20 KINLEY	464	93601/06 LEONID	330
90196/15 MIRAMAR	450	92922/05 DUBLIN	539	93478/29 DALMA	243	93609/15 BOMBILLA	296
90214/11 TIP	444	92922/06 DUBLIN	539	93509/20 GENTLE	436	93610/35 BIO	346
90215/13 ADRANO	442	92923/06 DUBLIN	511	93509/22 GENTLE	436	93610/50 BIO	346

Name / Art. Nr.	Page	Name / Art. Nr.	Page	Name / Art. Nr.	Page	Name / Art. Nr.	Page
93611/29 FEODORA	331	93659/35 WOODDESIGN	342	94423/05 LIPPA	448	94873/63 AGLAE	542
93612/29 KAGO	331	93660/35 WOODDESIGN	342	94424/15 NIEBLA	449	94874/03 KASHA	543
93613/55 DIRT	339	93661/15 JANE	300	94425/05 ZEBRA	470	94874/05 KASHA	543
93613/74 DIRT	339	93662/15 JANE	300	94425/15 ZEBRA	470	94874/17 KASHA	543
93614/70 ROPE	336	93663/18 GRACIAN	321	94426/05 SLASH	471	94905/75 GRIGORY	541
93615/70 TORRES	336	93664/06 SHOOT	244	94426/13 SLASH	471	94905/76 GRIGORY	527
93616/70 SALMA	335	93665/06 SHOOT	245	94427/29 ATHENA	462	94905/86 GRIGORY	541
93617/70 BENTE	335	93665/13 SHOOT	224	94428/13 PERRY	471	94906/76 HOME	527
93618/02 DESERT	338	93666/06 SHOOT	245	94429/05 MELVILLE	470	94913/15 QUADRI	540
93618/03 DESERT	338	93666/13 SHOOT	224	94429/13 MELVILLE	470	94916/05 WIDOW	506
93618/72 DESERT	338	93667/06 SHOOT	245	94433/05 VULCANO	216	94917/05 BRANDON	507
93619/15 BOMBILLA	296	93667/13 SHOOT	224	94433/65 VULCANO	217	94918/74 ELIAS	530
93620/15 BRILLIANCE	169	93668/76 FRIEDA	340	94434/05 VULCANO	216	94918/75 ELIAS	530
93620/29 BRILLIANCE	171	93669/15 GITSE	298	94434/65 VULCANO	217	94918/76 ELIAS	530
93621/15 BRILLIANCE	168	93670/15 GITSE	298	94435/15 NOBLE	186	94919/76 ELIAS	508
93621/29 BRILLIANCE	170	93674/21 ANCOLIE	324	94436/15 NOBLE	187	94921/35 YORKSHIRE	532
93622/15 BRILLIANCE	169	93674/29 ANCOLIE	324	94447/76 BILLY	240	94922/35 YORKSHIRE	532
93622/29 BRILLIANCE	171	93675/13 GRACE	325	94458/70 BOBBI	472	94923/35 PLANT	535
93623/15 BRILLIANCE	168	93675/29 GRACE	325	94459/70 BOBBI	472	94924/63 PLANT	535
93623/29 BRILLIANCE	170	93676/29 SID	326	94466/15 CRUSH	214	94927/70 CARMEN	528
93627/15 DUBAI	189	93677/76 BILLY	240	94466/85 CRUSH	214	94928/70 CARMEN	528
93628/15 DUBAI	189	93851/75 MAGNOLIA	446	94467/15 CRUSH	214	94929/15 FILMO	500
93630/70 FRIEDA	340	93851/76 MAGNOLIA	446	94467/85 CRUSH	214	94944/70 RINGS	250
93632/15 ICEDROP	218	93852/75 MAGNOLIA	446	94474/63 GRAFITTI	110	94945/70 RINGS	250
93633/05 ICEDROP	218	93852/76 MAGNOLIA	446	94475/63 GRAFITTI	110	94948/63 UMBRELLA	534
93634/05 ICEDROP	218	93909/70 KLEA	457	94476/63 GRAFITTI	110	96694A10 FILAMENT BULB	326
93635/22 INDEPENDENT	228	93983/70 ANAIS	457	94480/70 LAUREN	472	96697/05 EASYDIM BULB	10
93636/22 INDEPENDENT	228	93994/00 CITY	435	94481/70 LAUREN	472	96698/05 EASYDIM BULB	10
93637/22 INDEPENDENT	228	94010/20 NADIA	463	94491/70 TYPHOON	473	96699/05 EASYDIM BULB	10
93639/15 MANDAL	308	94012/05 ODINE	456	94492/70 TYPHOON	473	96700/05 EASYDIM BULB	11
93640/15 MANDAL	308	94014/13 SASHA	465	94669/15 LAWINA	608	96701/05 EASYDIM BULB	11
93642/15 RIGA	310	94014/20 SASHA	465	94671/05 DARCEY	609	96702/05 EASYDIM BULB	11
93643/15 RIGA	310	94046/05 ODINE	456	94672/05 DARCEY	609	96704A10 FILAMENT BULB	326
93645/15 SANDNESS	309	94056/70 BELIZ	456	94834/00 SHADOW	552	99122/03 JUNIOR	587
93645/29 SANDNESS	309	94057/70 BELIZ	456	94854/15 JOYA	198	99122/05 JUNIOR	587
93645/93 SANDNESS	309	94080/76 TOWN	468	94855/15 JOYA	198	99122/06 JUNIOR	587
93646/75 SANSIBAR	254	94088/70 EARTH	456	94860/09 EIFFEL TOWER	536	99122/11 JUNIOR	587
93647/75 SANSIBAR	254	94166/13 SPOCK	435	94861/05 ROM	540	F-93444/70 ANOUK	334
93648/75 SANSIBAR	254	94271/22 BRITNEY	466	94862/76 ROUTE 66	246	G90220/15 SUNSET	434
93649/00 SHERWOOD	343	94272/06 MIKA	467	94862/77 ROUTE 66	246	G90220/58 SUNSET	434
93650/00 STOCKHOLM	311	94273/76 RONALD	466	94863/76 ROUTE 66	246	G90220/69 SUNSET	434
93650/03 STOCKHOLM	311	94385/15 SKIRT	467	94863/77 ROUTE 66	246	G92734/06 JAAP	558
93651/70 STORM	251	94385/76 SKIRT	467	94868/63 GIRAFFE	230	G92752/72 EVERGREEN	520
93652/70 STORM	251	94411/06 TORANA	467	94868/86 GIRAFFE	231	G92926/01 VENEDIG	572
93654/15 TITANIC	307	94414/15 RACKET	463	94869/63 GIRAFFE	230	G92926/03 VENEDIG	572
93656/93 WATERFALL	176	94416/05 DIFFERENT	105	94869/86 GIRAFFE	231	G92926/05 VENEDIG	572
93657/93 WATERFALL	176	94421/00 FIZZY	449	94873/05 AGLAE	542	G92926/06 VENEDIG	572
93658/93 WATERFALL	176	94422/05 LIPPA	448	94873/22 AGLAE	542	G92926/11 VENEDIG	572

Name / Art. Nr.	Page	Name / Art. Nr.	Page	Name / Art. Nr.	Page	Name / Art. Nr.	Page				
G92928/13	BOMBAY	558	G93528/15	ELEGANCE	263	G94224/70	TONIA	430	G94390/15	FINE	404
G92935/03	ANTHONY	570	G93535/21	SUNRISE	285	G94224/74	TONIA	430	G94391/15	FINE	404
G92935/04	ANTHONY	570	G93536/21	SUNRISE	285	G94224/78	TONIA	430	G94392/05	SOLUTION	399
G92935/05	ANTHONY	570	G93537/15	VIEW	152	G94227/75	MARIUS	426	G94393/05	SOLUTION	399
G92935/11	ANTHONY	570	G93538/15	VIEW	152	G94228/75	MARIUS	426	G94394/15	PICTURE	382
G92935/17	ANTHONY	570	G93539/13	LIQUID	276	G94231/75	SALVIA	407	G94395/05	FLAT	371
G92936/05	ANTHONY	571	G93540/13	LIQUID	276	G94232/75	SALVIA	407	G94396/05	FLAT	371
G92936/11	ANTHONY	571	G93541/21	PLATE	284	G94245/15	SATURN	388	G94397/05	FLAT	371
G92941/22	HOLGER	564	G93542/15	ICE GLASS	266	G94246/05	FAKIR	424	G94398/77	SCRIPT	417
G92949/15	MELINA	518	G93543/15	WRAP	386	G94248/70	BUDAPEST	416	G94399/77	SCRIPT	417
G92960A03	MANAGUA	524	G93547/13	BETSY	283	G94249/70	BUDAPEST	416	G94402/13	VENTI	383
G92960A05	MANAGUA	524	G93548/13	PANARO	283	G94252/05	TIZIAN	373	G94403/13	MUSIC	420
G92960A17	MANAGUA	524	G93550/22	STRING	287	G94254/05	BABETT	373	G94404A15	VIRGINIA	412
G92968/04	DAISY	522	G93556/15	VIEW	152	G94255/05	BABETT	373	G94405A15	VIRGINIA	412
G92968/05	DAISY	522	G93568/15	VIEW	152	G94256/05	JARNO	372	G94410/15	KELLY	432
G92968/78	DAISY	522	G93575/15	INAYA	268	G94257/05	JARNO	372	G94412/15	NEW ORLEANS	410
G92970/15	ADRIANA	518	G93586/15	SAILING	156	G94258/05	KATALINA	372	G94417/13	JAIMIE	391
G92974/31	JOLEEN	559	G93596/15	SUNRISE LIGHT	153	G94259/05	KATALINA	372	G94432A72	LIGHT STR. MUSIC	476
G93004/13	LUCY	488	G93624/15	DELTA	264	G94264/15	MARTINO	403	G94438/15	FANTASIE	400
G93025/13	SUNNIVA	486	G93625/15	DELTA	154	G94265/15	MARTINO	403	G94439/15	FANTASIE	400
G93026/13	SUNNIVA	486	G93626/15	DELTA	154	G94266/15	MARTINO	403	G94440/15	CIRCLE	149
G93030/15	HANJO	272	G93641/13	QUASAR	280	G94267/15	MARTINO	403	G94442/21	IZON LED	418
G93031/15	THALASSA	275	G93644/15	SAILING	156	G94279/15	LARINA	401	G94443/21	IZON LED	418
G93032/77	ARTHUR	482	G93653/15	SUNRISE LIGHT	153	G94280/15	LARINA	401	G94444/21	IZON LED	418
G93033/77	DEMIAN	483	G93655/15	VENUS	260	G94281/15	LARINA	401	G94453/15	BEACH	148
G93035/13	FINN	484	G93671/15	GALINA	271	G94306/05	FAKIR	424	G94454/15	BEACH	148
G93036/13	OLLIE	485	G93672/15	GALINA	271	G94307/05	FALCO	425	G94455/15	BLOCK	384
G93036/31	OLLIE	485	G93673/77	GARDIS	270	G94308/05	EQUINOX	425	G94456/15	BLOCK	384
G93328/15	NASH XXL	293	G93931A72	LIGHT STR. LED	477	G94318/05	BASIC	414	G94457/15	BLOCK	384
G93418/15	NASH XL	292	G93932A72	LIGHT STR. LED	477	G94320/15	TRUST	415	G94460/05	CERES	364
G93434/15	ARLENA	274	G93933A72	LIGHT STR. LED	477	G94322/15	TOPIC	378	G94460/13	CERES	364
G93435/15	ARLENA	274	G94131/05	VIGOR	428	G94323/13	SLIDE	160	G94461/05	CERES	364
G93451/75	BERNADETTE	272	G94131/11	VIGOR	429	G94324/13	WAY	387	G94461/13	CERES	364
G93452/75	NEW HAVEN	269	G94141/05	VIGOR	428	G94325/05	VULKAN	397	G94462/05	CERES	366
G93453/75	RIVERSIDE	269	G94141/11	VIGOR	429	G94326/15	VISION	385	G94462/13	CERES	366
G93454/75	MIRELLA	164	G94142/13	SILKE	435	G94327/13	OVAL	415	G94463/05	CERES	366
G93455/13	NARJA	282	G94145/15	SAO PAULO	410	G94330/21	FIXED	419	G94463/13	CERES	366
G93504/13	CURVED	281	G94151/05	VIGOR	428	G94333/15	NEW DESIGN	381	G94464/05	CERES	367
G93505/15	STYLE II	265	G94155/15	SVEA	402	G94336/05	FREE	398	G94464/13	CERES	367
G93506/15	STYLE II	265	G94156/15	ALICA	402	G94337/05	FREE	398	G94465/15	CIRCLE	149
G93507/15	GATE	155	G94158/05	VIGOR	429	G94338/05	FREE	398	G94468/13	DNA	158
G93508/15	GATE	155	G94163/15	CATHLEEN	406	G94343/77	DAJANA	390	G94469/13	DNA	158
G93510/13	SURF	277	G94164/15	MOLLIE	406	G94348/15	YUNAN	388	G94470/13	DNA	159
G93511/13	SURF	277	G94209/93	BONNIE	74	G94368/15	GUDY	413	G94471/13	DNA	159
G93517/13	TREND	279	G94214/70	ELANA	430	G94369/15	GUDY	413	G94472/15	ETERNITY	379
G93525/15	ELEGANT	262	G94216/05	FIALA	430	G94380/05	TEIDE	396	G94473/13	FAIR	391
G93526/15	ELEGANT	262	G94220/75	MALINDA	414	G94380/30	TEIDE	396	G94477/35	HARDWOOD	422
G93527/15	ELEGANT	263	G94222/75	ROLANDA	414	G94389/15	FINE	404	G94478/35	HARDWOOD	422

Name / Art. Nr.	Page	Name / Art. Nr.	Page		
G94479/35	HARDWOOD	422	G94807/06	NIKITA	560
G94482/13	LOOP	392	G94808/11	BRENDAN	560
G94483/15	MOVABLE	21	G94810/75	BRADLEY	561
G94484/15	MOVABLE	21	G94812/75	SHELDON	561
G94485/15	NEPTUN	363	G94816/04	KATRINA	568
G94486/15	NEPTUN	363	G94816/05	KATRINA	568
G94487/15	NEPTUN	363	G94816/06	KATRINA	568
G94488/05	SOFT	399	G94816/11	KATRINA	568
G94489/15	TOGETHER	385	G94818/13	CARLINO	490
G94490/15	TRAFFIC	383	G94825/77	MEET	498
G94493/05	CERES	367	G94837/02	PHARRELL	584
G94493/13	CERES	367	G94837/04	PHARRELL	584
G94498/05	CERES	365	G94837/07	PHARRELL	584
G94498/13	CERES	365	G94837/17	PHARRELL	584
G94649/05	EASY CLIP	596	G94871/05	GLENN	563
G94649/13	EASY CLIP	596	G94871/06	GLENN	563
G94650/05	EASY CLIP	596	G94895/06	KARINA	562
G94650/13	EASY CLIP	596	G94907/06	NEW YORK	538
G94651/05	EASY CLIP	597	G94908/06	NEW YORK	510
G94651/13	EASY CLIP	597	G94909/15	CLAP	565
G94652/05	EASY CLIP	597	G94920/05	NELE	562
G94652/13	EASY CLIP	597	G94920/06	NELE	562
G94658/05	KOLJA	593	G94946/13	SLIDE	160
G94659/05	KOLJA	593	G94947/13	SLIDE	160
G94660/05	LAUREEN	592	G96284/72	EVERGREEN	521
G94661/05	LAUREEN	592	G98808/15	PALIN	426
G94667/05	TANIEL	598	G98809/05	FAKIR	424
G94667/13	TANIEL	598	G98810/05	SPARI LED	489
G94668/05	TANEL	599	G98811/05	SPARI LED	489
G94673/05	FRANCA	600	G98813/05	MIRAMAR LED	431
G94673/13	FRANCA	600	G98813/13	MIRAMAR LED	431
G94674/05	CLASSIC LED	605	G98813/15	MIRAMAR LED	431
G94674/13	CLASSIC LED	605			
G94675/05	CLASSIC LED	604			
G94675/13	CLASSIC LED	604			
G94676/05	FELIZIA LED	603			
G94676/13	FELIZIA LED	603			
G94677/05	FELIZIA LED	602			
G94677/13	FELIZIA LED	602			
G94684/05	CLASSIC LED	605			
G94684/13	CLASSIC LED	605			
G94685/05	CLASSIC LED	604			
G94685/13	CLASSIC LED	604			
G94686/05	FELIZIA LED	603			
G94686/13	FELIZIA LED	603			
G94687/05	FELIZIA LED	602			
G94687/13	FELIZIA LED	602			
G94689A13	HONOR	594			

**Deutschland/Österreich/Schweiz**

Brilliant AG  
Brillantstr. 1  
D-27438 Postfach 1109  
D-27442 Gnarrenburg  
Tel.: +49 (0) 47 63 89 0  
Fax: +49 (0) 47 63 89 171  
Internet: www.brilliant-ag.com  
info@brilliant-ag.com

**Italia**

Brilliant AG Italia  
Strada 1, Palazzo F1,  
Milanofiori  
I - 20090 Assago (MI)  
Tel.: + 39 0 2 40 91 56 71  
Fax: + 39 0 2 40 91 75 50  
info@brilliant-ag.it

**België/Luxemburg**

Brilliant Benelux  
12, rue Faidherbe  
3ème étage  
F - 59000 Lille  
Tel.: + 33 (0) 3 20 13 28 04  
Fax: + 33 (0) 3 20 55 75 09  
info@brilliant-ag.be

**Danmark**

Brilliant Danmark  
Haarup Tvaervej 1  
8600 Silkeborg  
Tel.: + 45 97 47 26 95  
Fax: + 45 97 47 14 95  
info@brilliant-ag.dk

**España / Portugal**

Brilliant Ibérica S.L.  
Pol. Ind. Más Blau I, Edificio Muntadas I  
Entrada A  
Carrer Bergueda 1  
Edificio Muntadas A  
08820 EL PRAT DE LLOBREGAT  
Tel.: +34 9 31 42 62 81  
info@brilliant-ag.es

**France**

Service France  
Brillantstr. 1  
D-27438 Postfach 1109  
D-27442 Gnarrenburg  
Tel.: + 33 (0) 3 87 95 93 30  
+ 33 (0) 3 87 95 93 31  
Fax: + 33 (0) 3 87 95 93 32  
info@brilliant-ag.fr

**Great Britain**

Poole Lighting Ltd.  
9 Cabot Lane  
Creekmore  
Poole  
Dorset  
BH23 3PE  
Tel.: + 44 (0) 120 269 7344  
info@poolelighting.com

**Hellas**

Brilliant AG  
Brillantstr. 1  
D-27438 Postfach 1109  
D-27442 Gnarrenburg  
Tel.: +49 (0) 47 63 89 0  
Fax: +49 (0) 47 63 89 170  
Internet: www.brilliant-ag.com  
info@brilliant-ag.com

**Ireland**

Peter Simmons  
Mobile.: +353 (0) 86 781 2852  
ireland@brilliant-ag.com

**Macedonia**

AS Light  
Voin Drashkici 32  
1000 Skopje, R. Macedonia  
Tel./Fax: +389 (0) 2/3117 129  
Mobile: +389 (0) 75/245 728; 39 30 29  
macedonia@brilliant-ag.com

**Nederland**

Brilliant Benelux  
12 rue Faidherbe  
3ème étage  
F-59000 Lille  
Tel.: +31 (0) 35 531 8208  
Fax: +31 (0) 35 533 0503  
info@brilliant-ag.nl

**Norge**

Triolux AS  
Tel.: +47 38 18 58 80  
norge@brilliant-ag.com

**Polska**

DeLighting Poland Spolka  
Z Ograniczona  
Odpowiedzialnoscia  
Psary Male,  
u. Budowlana 10  
62-300 Wrzesnia  
Tel.: +48 61 436 74 81  
Fax.: +48 60 777 34 94  
polska@brilliant-ag.com

**Rossija**

OOO Brilliant RUS  
Ryvabinovaya St.55 bl.2  
121471 Moscow  
Tel./Fax: +7 (495) 443-2364  
Tel./Fax: +7 (495) 446-5934  
sale@brilliant-rus.ru  
www.brilliant-rus.ru

**Sverige**

Brilliant Sweden  
Tel.: +46 8 559 22 535  
info@brilliant-ag.se

**Türkiye**

Brilliant Aydınlatma İthalat İhracat  
ve Tic. Ltd. Şti.  
Mimar Sinan Mah, Cavaşbaşı Cad.  
Ayfer Sk. No:13 D:5  
Cekmeköy/Istanbul PK:34782  
Tel.: +90 216 640 17 93  
Fax.: +90 216 640 17 50  
info@brilliant.com.tr  
www.brilliant.com.tr

**U.A.E.**

Brilliant Arabia  
Office Middle and Far East,  
North Africa  
Po Box 371027  
Dubai - UAE  
Tel.: +971 50 10 06 28 5  
Fax: +971 42395615  
Mobil: +971 50 10 06 28 5  
arabia@brilliant-ag.com

**Central Africa and Caribbean**

FM Global  
Bareel 13  
9170 De Klinge  
Belgium  
Tel.: +32 476 912 108  
africa@brilliant-ag.com

**Česká Republika /  
Slovenská Republika**

René Schmidt  
Jamnická 456  
Staré Město  
Frýdek-Místek  
CZ-738 01  
Tel.: +420 603 537 120  
Fax.: +420 226 013 302  
czech@brilliant-ag.com  
slovenska-republika@brilliant-ag.com

**Serbien, Bosnien und Herzogowina**

LED Rasveta - Inženjering d.o.o.  
Bul. Muhajla Pupina 10d/20 n.p.  
11070 Novi Beograd  
Serbien  
Tel.: +381 11 311 31 93  
Fax: +381 11 314 83 39  
serbia@brilliant-ag.com  
www.vtac-ledrasveta.rs











**Brilliant AG**

Brillantstr. 1 · D-27442 Gnarrenburg  
Tel.: +49 (0) 47 63 89 0 · Fax: +49 (0) 47 63 89 171  
international\_sales@brilliant-ag.com · www.brilliant-ag.com

92067/00



4 004353 261428